



# H40N03E

N-Channel Enhancement-Mode MOSFET (25V, 40A)

## Features

- $R_{DS(on)}=16m\Omega @ V_{GS}=10V, I_D=20A$
- $R_{DS(on)}=25m\Omega @ V_{GS}=4.5V, I_D=20A$
- Advanced trench process technology
- High Density Cell Design for Ultra Low On-Resistance
- Specially Designed for DC/DC Converters and Motor Drivers
- Fully Characterized Avalanche Voltage and Current
- Improved Shoot-Through FOM

### H40N03E Pin Assignment

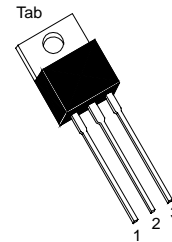

3-Lead Plastic **TO-220AB**  
 Package Code: E  
 Pin 1: Gate  
 Pin 2 & Tab: Drain  
 Pin 3: Source

Internal Schematic Diagram

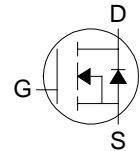

## Maximum Ratings & Thermal Characteristics

( $T_A=25^\circ C$  unless otherwise noted)

Parameter	Symbol	Value	Units
Drain-Source Voltage	$V_{DS}$	25	V
Gate-Source Voltage	$V_{GS}$	$\pm 20$	V
Continuous Drain Current	$I_D$	40	A
Pulsed Drain Current *1	$I_{DM}$	160	A
Maximum Power Dissipation @ $T_C=25^\circ C$	$P_D$	50	W
Operating Junction and Storage Temperature Range	$T_J, T_{stg}$	-55 to 150	$^\circ C$
Avalanche Energy with Single Pulse $I_D=35A, V_{DD}=20V, L=0.14mH$	$E_{AS}$	300	mJ
Junction-to-Case Thermal Resistance	$R_{\theta JC}$	2.1	$^\circ C/W$
Junction-to-Ambient Thermal Resistance(PCB mounted)*2	$R_{\theta JA}$	55	$^\circ C/W$

\*1: Maximum DC current limited by the package.  
 \*2: 1-in<sup>2</sup> 2oz Cu PCB board

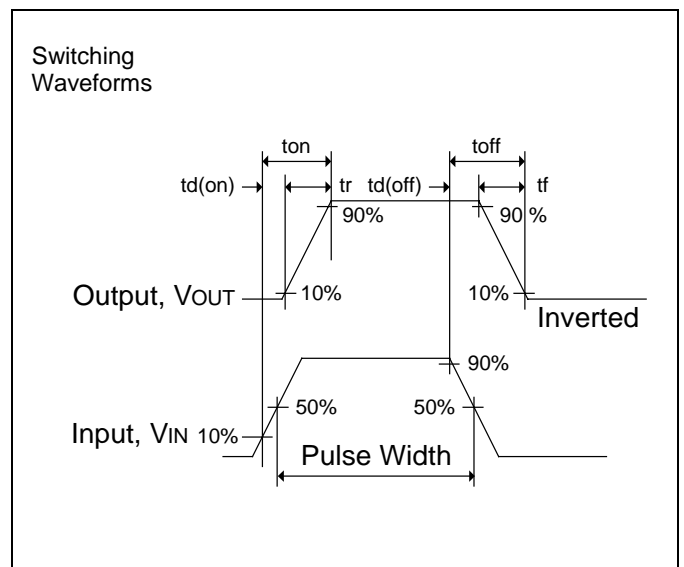
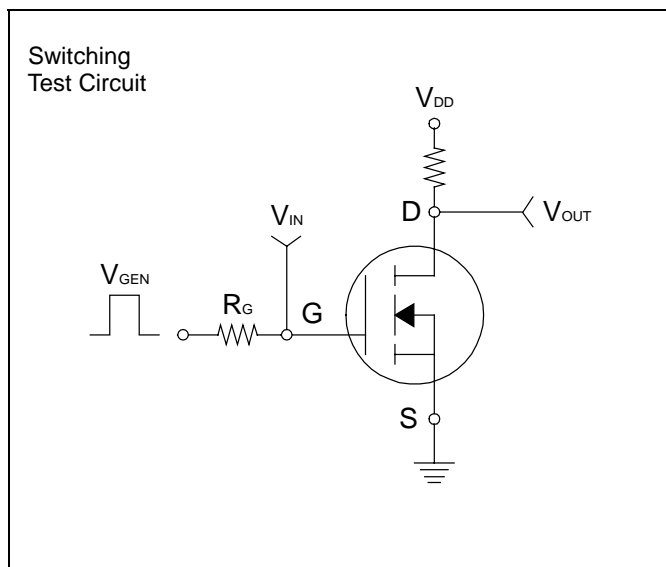



### Electrical Characteristics

Characteristic	Symbol	Test Condition	Min.	Typ.	Max.	Unit
Static						
Drain-Source Breakdown Voltage	$BV_{DSS}$	$V_{GS}=0V, I_D=250\mu A$	25	-	-	V
Drain-Source On-State Resistance	$R_{DS(on)}$	$V_{GS}=4.5V, I_D=20A$	-	-	25	m $\Omega$
		$V_{GS}=10V, I_D=20A$	-	-	16	
Gate Threshold Voltage	$V_{GS(th)}$	$V_{DS}=V_{GS}, I_D=250\mu A$	1	1.6	3	V
Zero Gate Voltage Drain Current	$I_{DSS}$	$V_{DS}=24V, V_{GS}=0V$	-	-	1	$\mu A$
Gate Body Leakage	$I_{GSS}$	$V_{GS}=\pm 20V, V_{DS}=0V$	-	-	$\pm 100$	nA
Gate Resistance	$R_g$	$V_{DS}=0V, V_{GS}=1V$ at 1MHz	-	1	-	$\Omega$
Forward Transconductance	$g_{fs}$	$V_{DS}=10V, I_D=35A$	-	6	-	S
Dynamic						
Total Gate Charge	$Q_g$	$V_{DS}=15V, I_D=35A, V_{GS}=10V$	-	18.4	-	nC
Gate-Source Charge	$Q_{gs}$		-	3.57	-	
Gate-Drain Charge	$Q_{gd}$		-	2.9	-	
Turn-On Delay Time	td(on)	$V_{DD}=15V, R_L=15\Omega, I_D=1A$ $V_{GEN}=10V, R_G=24\Omega$	-	11.7	-	nS
Turn-On Rise Time	tr		-	3.87	-	
Turn-Off Delay Time	td(off)		-	32.13	-	
Turn-Off Fall Time	tf		-	5.4	-	
Input Capacitance	$C_{iss}$	$V_{DS}=15V, V_{GS}=0V, f=1MHz$	-	1176.3	-	pF
Output Capacitance	$C_{oss}$		-	268.43	-	
Reverse Transfer Capacitance	$C_{rss}$		-	142.67	-	
Source-Drain Diode						
Max. Diode Forward Current	$I_S$		-	-	35	A
Diode Forward Voltage	$V_{SD}$	$I_S=20A, V_{GS}=0V$	-	0.87	1.5	V

NOTE: Pulse Test: Pulse Width  $\leq 300\mu s$ , Duty Cycle  $\leq 2\%$



### Characteristics Curve

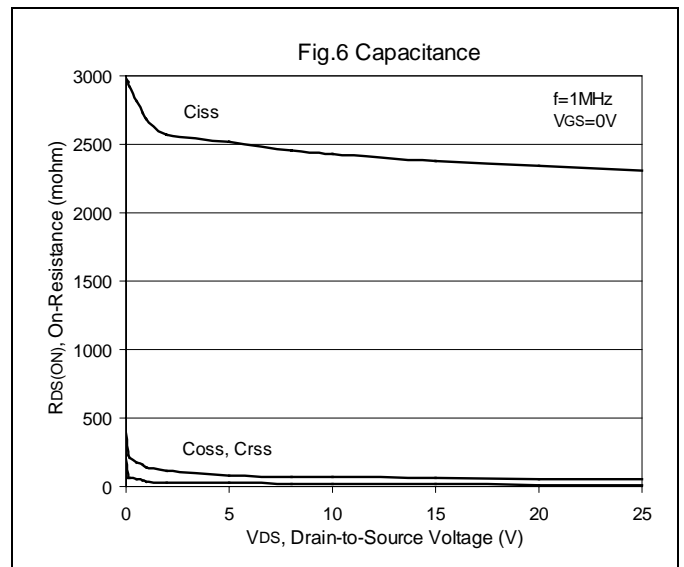
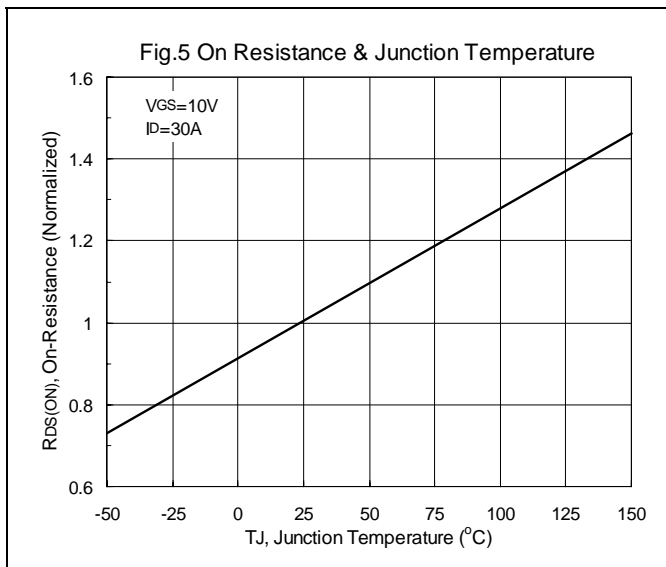
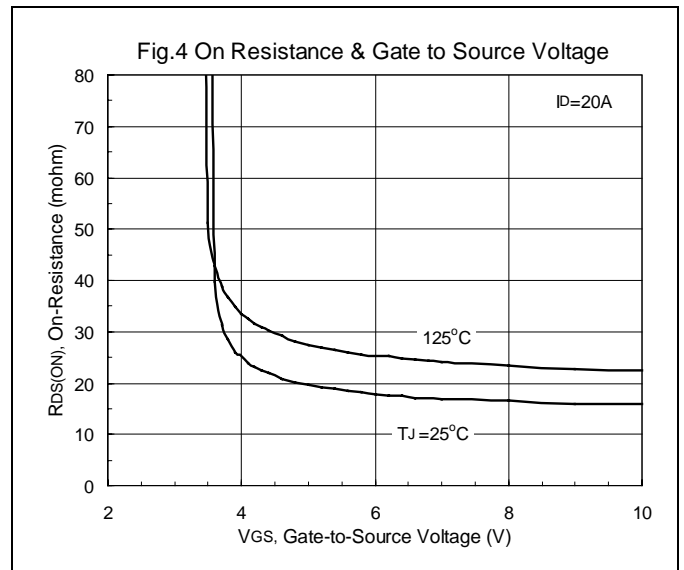
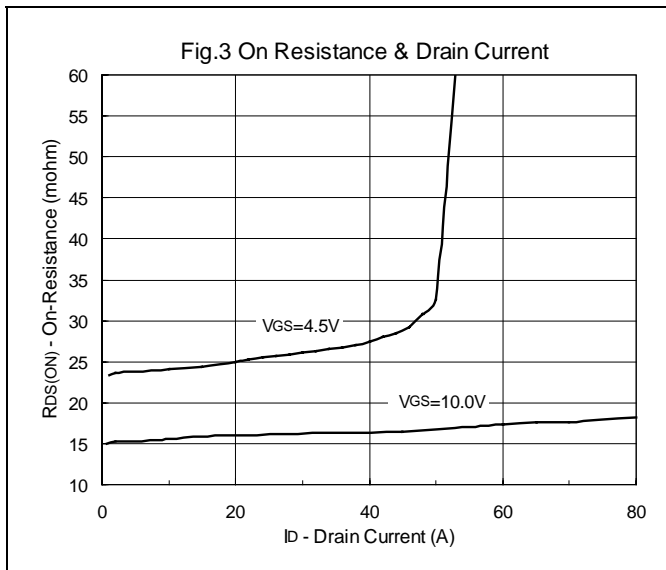
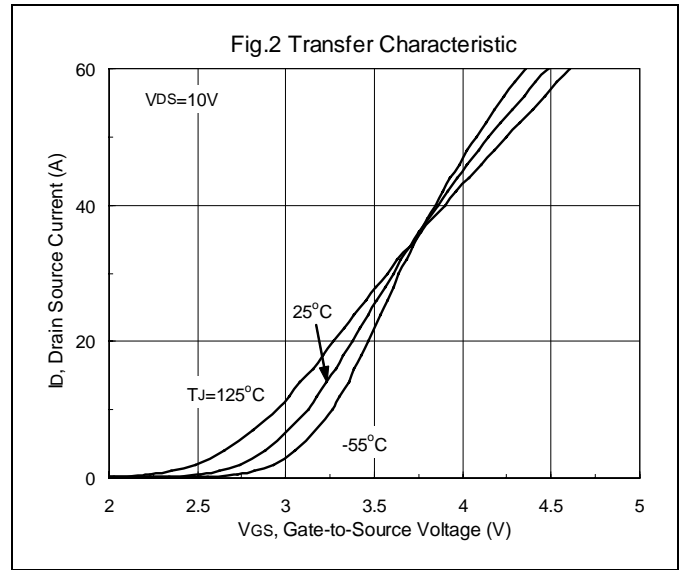
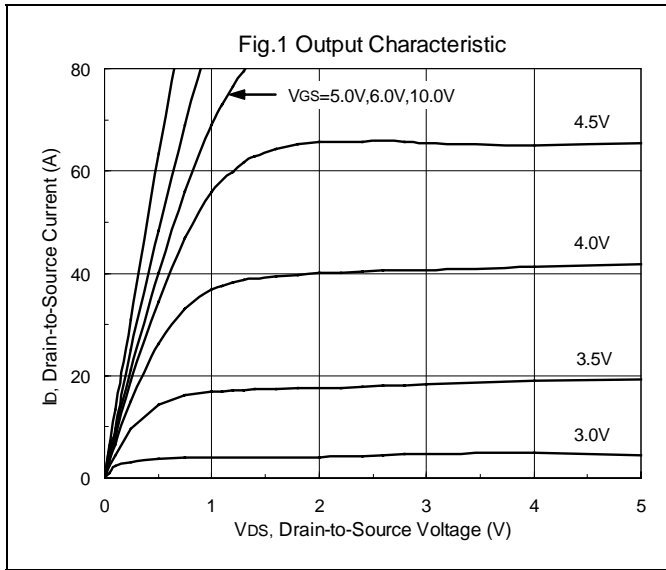



### TO-220AB Dimension

3-Lead TO-220AB  
Plastic Package  
HSMC Package Code: E

**Marking:**

Pb Free Mark  
 Pb-Free: "•" (Note)  
 Normal: None

Date Code      Control Code

Note: Green label is used for pb-free packing

Pin Style: 1.Gate 2 & Tab.Drain 3.Source

Material:

- Lead solder plating: Sn60/Pb40 (Normal), Sn/3.0Ag/0.5Cu or Pure-Tin (Pb-free)
- Mold Compound: Epoxy resin family, flammability solid burning class: UL94V-0

DIM	Min.	Max.
A	5.58	7.49
B	8.38	8.90
C	4.40	4.70
D	1.15	1.39
E	0.35	0.60
F	2.03	2.92
G	9.66	10.28
H	-	*16.25
I	-	*3.83
J	3.00	4.00
K	0.75	0.95
L	2.54	3.42
M	1.14	1.40
N	-	*2.54
O	12.70	14.27
P	14.48	15.87

\*: Typical, Unit: mm

#### Important Notice:

- All rights are reserved. Reproduction in whole or in part is prohibited without the prior written approval of HSMC.
- HSMC reserves the right to make changes to its products without notice.
- **HSMC semiconductor products are not warranted to be suitable for use in Life-Support Applications, or systems.**
- HSMC assumes no liability for any consequence of customer product design, infringement of patents, or application assistance.

#### Head Office And Factory:

- **Head Office** (Hi-Sincerity Microelectronics Corp.): 10F., No. 61, Sec. 2, Chung-Shan N. Rd. Taipei Taiwan R.O.C.  
Tel: 886-2-25212056 Fax: 886-2-25632712, 25368454
- **Factory 1:** No. 38, Kuang Fu S. Rd., Fu-Kou Hsin-Chu Industrial Park Hsin-Chu Taiwan. R.O.C  
Tel: 886-3-5983621~5 Fax: 886-3-5982931



### Soldering Methods for HSMC's Products

1. Storage environment: Temperature=10°C~35°C Humidity=65%±15%
2. Reflow soldering of surface-mount devices

Figure 1: Temperature profile

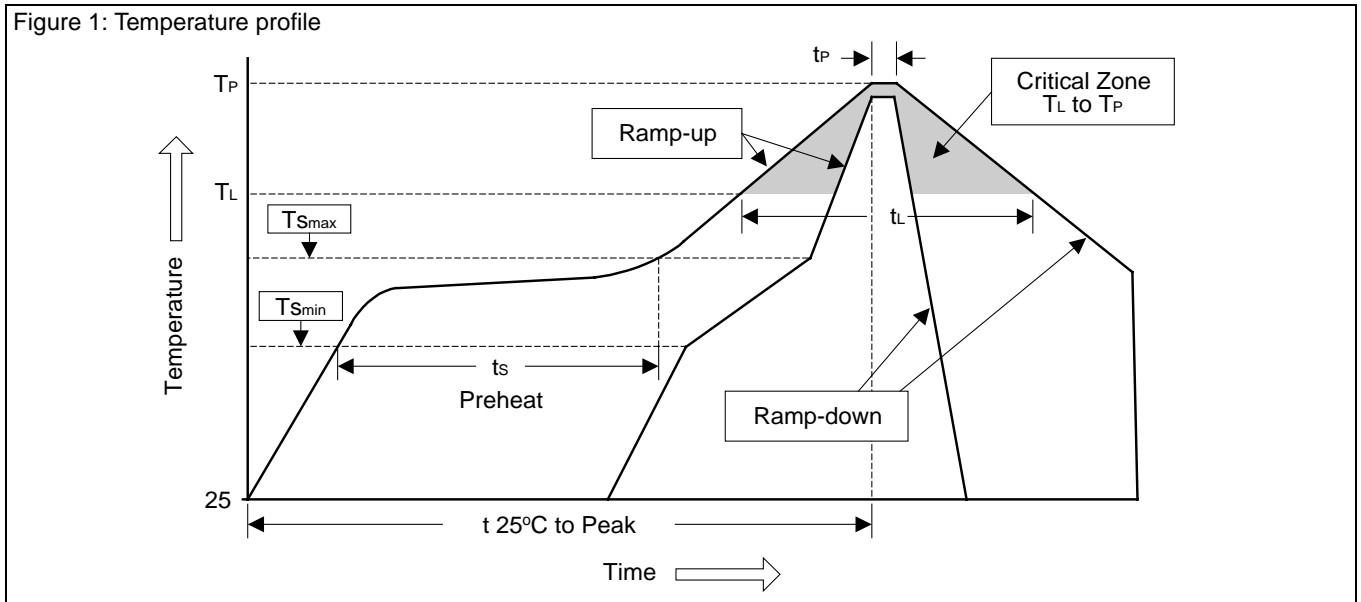

Profile Feature	Sn-Pb Eutectic Assembly	Pb-Free Assembly
Average ramp-up rate ( $T_L$ to $T_P$ )	<3°C/sec	<3°C/sec
Preheat		
- Temperature Min ( $T_{Smin}$ )	100°C	150°C
- Temperature Max ( $T_{Smax}$ )	150°C	200°C
- Time (min to max) ( $t_s$ )	60~120 sec	60~180 sec
$T_{Smax}$ to $T_L$		
- Ramp-up Rate	<3°C/sec	<3°C/sec
Time maintained above:		
- Temperature ( $T_L$ )	183°C	217°C
- Time ( $t_L$ )	60~150 sec	60~150 sec
Peak Temperature ( $T_P$ )	240°C +0/-5°C	260°C +0/-5°C
Time within 5°C of actual Peak Temperature ( $t_p$ )	10~30 sec	20~40 sec
Ramp-down Rate	<6°C/sec	<6°C/sec
Time 25°C to Peak Temperature	<6 minutes	<8 minutes

3. Flow (wave) soldering (solder dipping)

Products	Peak temperature	Dipping time
Pb devices.	245°C ±5°C	5sec ±1sec
Pb-Free devices.	260°C +0/-5°C	5sec ±1sec