

## White LED in 5mm (T<sup>1</sup>/<sub>3</sub>) Waterclear Package

Color	Type	Technology	Angle of Half Intensity ±φ
White	TLHW5400	InGaN / YAG on SiC	30°

### Description

High Intensity LED with typical color coordinates  $x = 0.33$ ,  $y = 0.33$  (typical color temperature 5500k). This LED emits white light with a high color rendering index. The emission spectrum is tuned for ideal white, without the impression of being blue shaded or "cold". The package is a standard T 1 <sup>3</sup>/<sub>4</sub>. The internal reflector is filled with a compound of YAG phosphor and an elastic resin. Therefore the chip is better protected against temperature cycle stress. The phosphor converts the blue emission of the InGaN chip partially to amber, which mixes with the remaining blue to produce white.

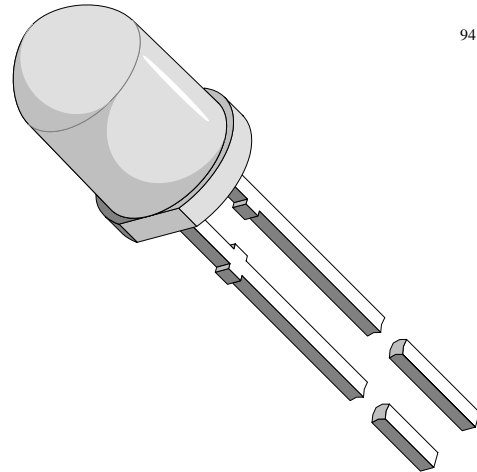

94 8631

### Features

- High efficient InGaN technology
- Chromaticity coordinate categorized according to CIE1931 per packing unit
- Typical chromaticity coordinates  
 $x = 0.33$ ,  $y = 0.33$
- Typical color temperature 5500K
- ESD class 1
- Wide viewing angle
- Chip embedded in elastic resin, improved robustness against temperature cycle stress

### Applications

Indicator and backlighting  
Indoor and outdoor message panels  
Flat backlight for LCDs, switches and symbols  
Alternative to incandescent lamps  
Marker lights

### Absolute Maximum Ratings

$T_{amb} = 25^{\circ}\text{C}$ , unless otherwise specified

#### TLHW5400

Parameter	Test Conditions	Symbol	Value	Unit
Reverse voltage		$V_R$	5	V
DC forward current	$T_{amb} \leq 56^{\circ}\text{C}$	$I_F$	30	mA
Surge forward current	$t_p \leq 10 \mu\text{s}$	$I_{FSM}$	0.1	A
Power dissipation	$T_{amb} \leq 56^{\circ}\text{C}$	$P_V$	126	mW
Junction temperature		$T_j$	100	$^{\circ}\text{C}$
Operating temperature range		$T_{amb}$	-40 to +100	$^{\circ}\text{C}$
Storage temperature range		$T_{stg}$	-40 to +100	$^{\circ}\text{C}$
Soldering temperature	$t \leq 5 \text{ s}$	$T_{sd}$	260	$^{\circ}\text{C}$
Thermal resistance junction/ambient		$R_{thJA}$	350	K/W

### Optical and Electrical Characteristics

$T_{amb} = 25^{\circ}\text{C}$ , unless otherwise specified

#### White (TLHW5400)

Parameter	Test Conditions	Type	Symbol	Min	Typ	Max	Unit
Luminous intensity	$I_F = 20 \text{ mA}$	TLHW5400	$I_V$	180	350		mcd
Chromaticity coordinate x acc. to CIE 1931	$I_F = 20 \text{ mA}$	TLHW5400	x		0.33		
Chromaticity coordinate y acc. to CIE 1931	$I_F = 20 \text{ mA}$	TLHW5400	y		0.33		
Angle of half intensity	$I_F = 20 \text{ mA}$		$\phi$		$\pm 30$		deg
Forward voltage	$I_F = 20 \text{ mA}$		$V_F$		3.5	4.2	V
Reverse voltage	$I_R = 10 \mu\text{A}$		$V_R$	5			V
Temperature coefficient of $V_F$	$I_F = 20 \text{ mA}$		$TC_{VF}$		-4		mV/K
Temperature coefficient of $I_V$	$I_F = 20 \text{ mA}$		$TC_{IV}$		-0.5		% / K

### Chromaticity Coordinate Classification

Group	X		Y	
	min	max	min	max
3	0.280	0.325	0.210	0.340
4	0.305	0.350	0.260	0.390
5	0.330	0.375	0.310	0.440

**Typical Characteristics** ( $T_{amb} = 25^{\circ}\text{C}$ , unless otherwise specified)

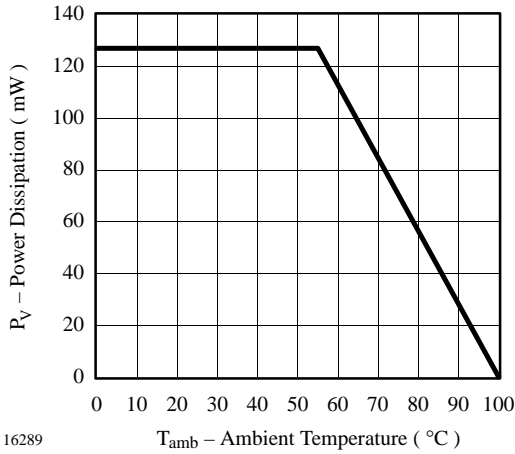

Figure 1 Power Dissipation vs. Ambient Temperature

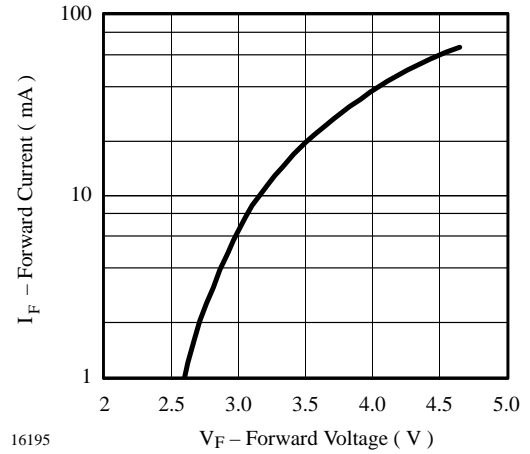

Figure 4 Forward Current vs. Forward Voltage

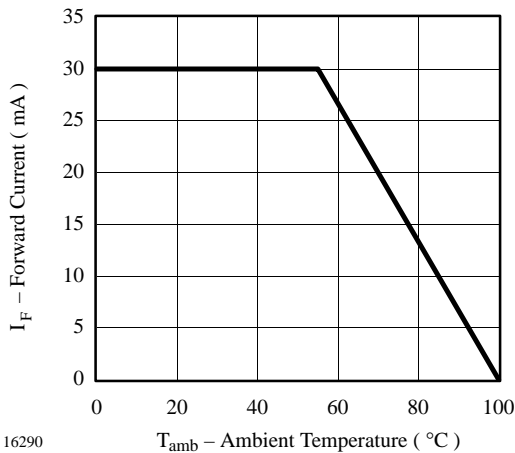

Figure 2 Forward Current vs. Ambient Temperature

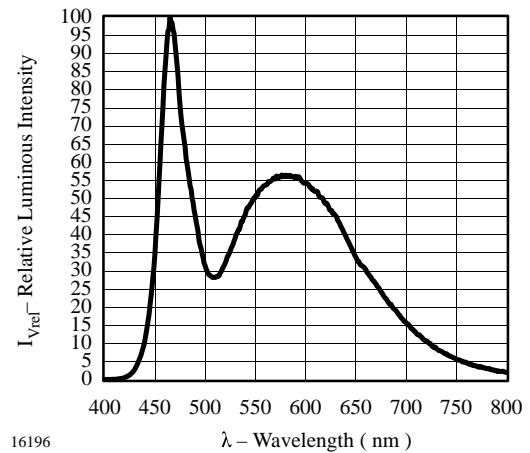

Figure 5 Relative Luminous Intensity vs. Wavelength

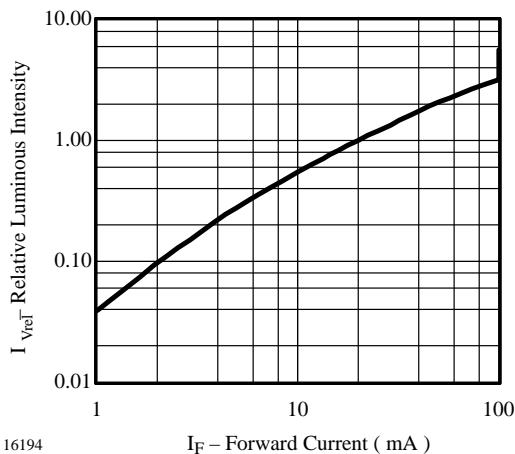

Figure 3 Relative Luminous Intensity vs. Forward Current

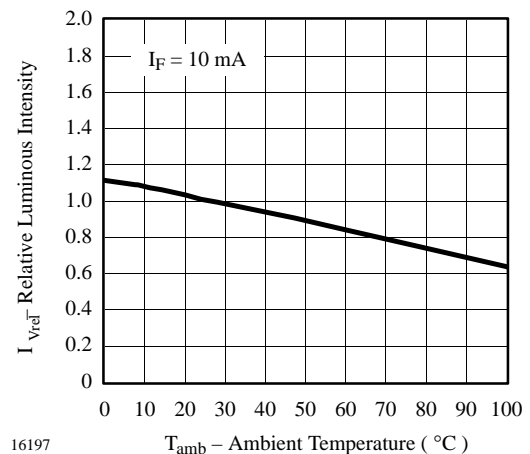

Figure 6 Rel. Luminous Intensity vs. Ambient Temperature

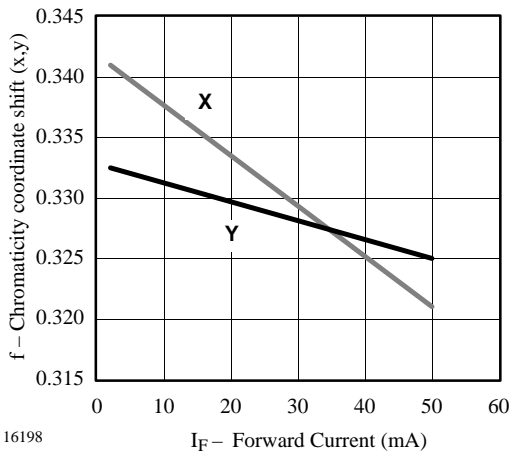

Figure 7 Chromaticity Coordinate Shift vs. Forward Current

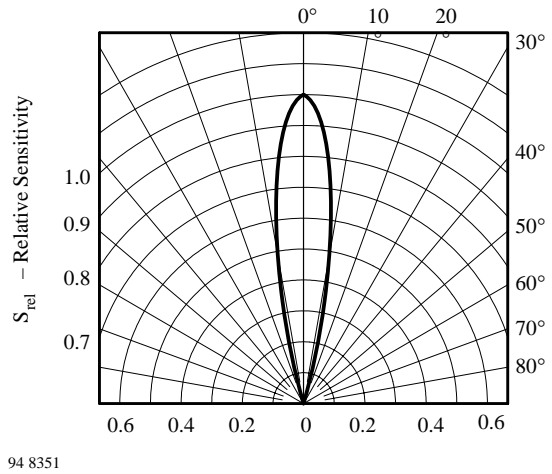

Figure 9 Rel. Luminous Intensity vs. Angular Displacement

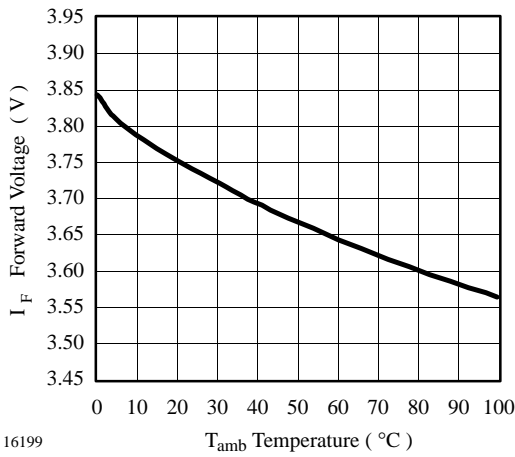

Figure 8 Forward Voltage vs. Ambient Temperature

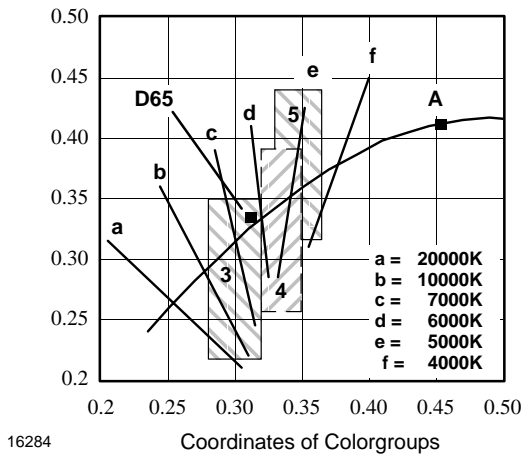
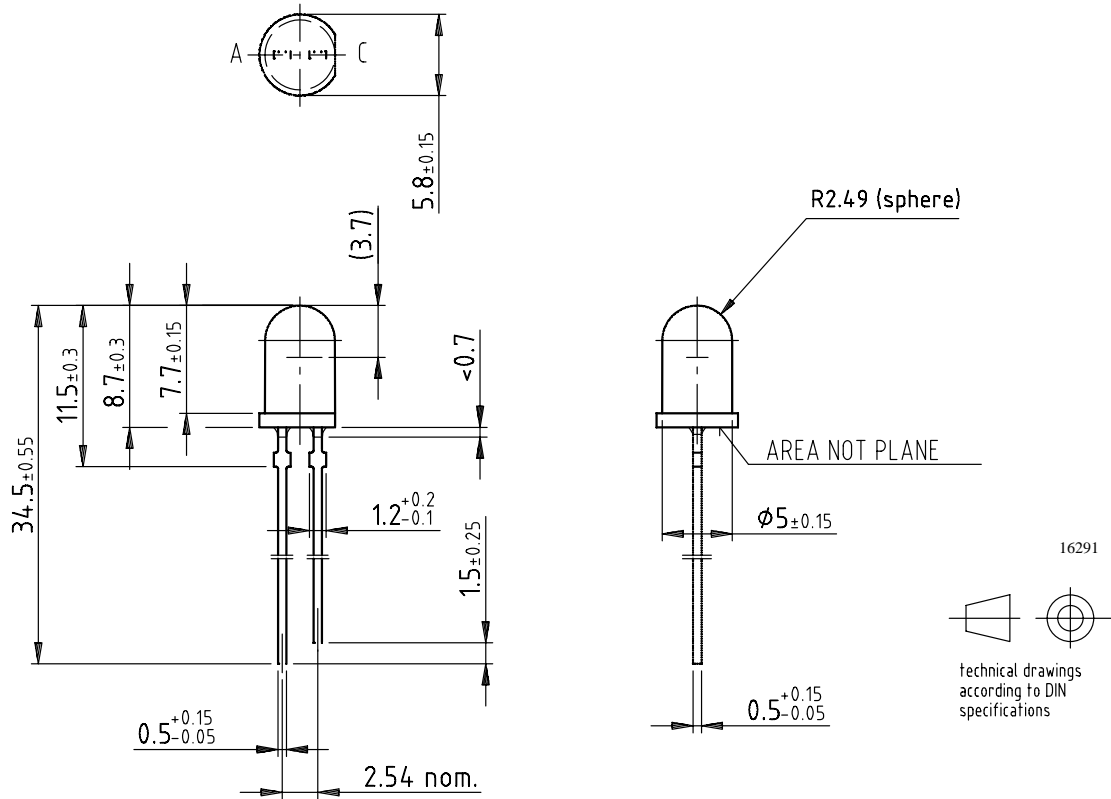

Figure 10 Coordinates of Colorgroups

**Dimensions in mm**



### Ozone Depleting Substances Policy Statement

It is the policy of **Vishay Semiconductor GmbH** to

1. Meet all present and future national and international statutory requirements.
2. Regularly and continuously improve the performance of our products, processes, distribution and operating systems with respect to their impact on the health and safety of our employees and the public, as well as their impact on the environment.

It is particular concern to control or eliminate releases of those substances into the atmosphere which are known as ozone depleting substances (ODSs).

The Montreal Protocol (1987) and its London Amendments (1990) intend to severely restrict the use of ODSs and forbid their use within the next ten years. Various national and international initiatives are pressing for an earlier ban on these substances.

**Vishay Semiconductor GmbH** has been able to use its policy of continuous improvements to eliminate the use of ODSs listed in the following documents.

1. Annex A, B and list of transitional substances of the Montreal Protocol and the London Amendments respectively
2. Class I and II ozone depleting substances in the Clean Air Act Amendments of 1990 by the Environmental Protection Agency (EPA) in the USA
3. Council Decision 88/540/EEC and 91/690/EEC Annex A, B and C (transitional substances) respectively.

**Vishay Semiconductor GmbH** can certify that our semiconductors are not manufactured with ozone depleting substances and do not contain such substances.

**We reserve the right to make changes to improve technical design and may do so without further notice.**

Parameters can vary in different applications. All operating parameters must be validated for each customer application by the customer. Should the buyer use Vishay-Telefunken products for any unintended or unauthorized application, the buyer shall indemnify Vishay-Telefunken against all claims, costs, damages, and expenses, arising out of, directly or indirectly, any claim of personal damage, injury or death associated with such unintended or unauthorized use.

Vishay Semiconductor GmbH, P.O.B. 3535, D-74025 Heilbronn, Germany  
Telephone: 49 (0) 7131 67 2831, Fax number: 49 (0) 7131 67 2423