

2SC3979, 2SC3979A

Silicon NPN triple diffusion planar type

For high breakdown voltage high-speed switching

■ Features

- High-speed switching
- High collector to base voltage V_{CBO}
- Wide area of safe operation (ASO)
- Satisfactory linearity of forward current transfer ratio h_{FE}
- Full-pack package which can be installed to the heat sink with one screw

■ Absolute Maximum Ratings $T_C = 25^\circ\text{C}$

Parameter		Symbol	Rating	Unit
Collector to base voltage	2SC3979	V_{CBO}	900	V
	2SC3979A		1 000	
Collector to emitter voltage	2SC3979	V_{CES}	900	V
	2SC3979A		1 000	
Collector to emitter voltage		V_{CEO}	800	V
Emitter to base voltage		V_{EBO}	7	V
Peak collector current		I_{CP}	5	A
Collector current		I_C	3	A
Base current		I_B	1	A
Collector power dissipation	$T_C = 25^\circ\text{C}$	P_C	40	W
	$T_a = 25^\circ\text{C}$		2	
Junction temperature		T_j	150	$^\circ\text{C}$
Storage temperature		T_{stg}	-55 to +150	$^\circ\text{C}$

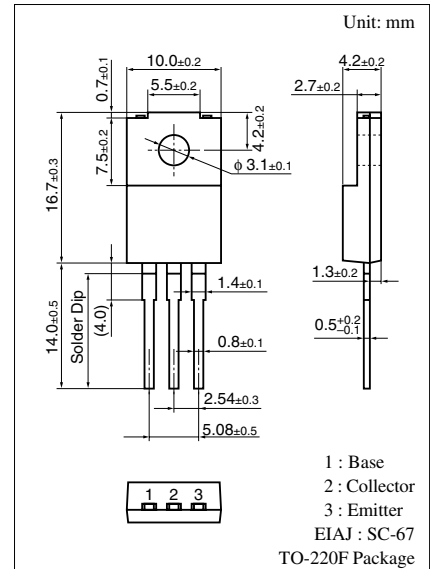

■ Electrical Characteristics $T_C = 25^\circ\text{C}$

Parameter		Symbol	Conditions	Min	Typ	Max	Unit
Collector cutoff current	2SC3979	I_{CBO}	$V_{CB} = 900\text{ V}, I_E = 0$			50	μA
	2SC3979A		$V_{CB} = 1\ 000\text{ V}, I_E = 0$			50	
Emitter cutoff current		I_{EBO}	$V_{EB} = 7\text{ V}, I_C = 0$			50	μA
Collector to emitter voltage		V_{CEO}	$I_C = 10\text{ mA}, I_B = 0$	800			V
Forward current transfer ratio		h_{FE1}	$V_{CE} = 5\text{ V}, I_C = 0.1\text{ A}$	8			
		h_{FE2}	$V_{CE} = 5\text{ V}, I_C = 0.8\text{ A}$	6			
Collector to emitter saturation voltage		$V_{CE(sat)}$	$I_C = 0.8\text{ A}, I_B = 0.16\text{ A}$			1.5	V
Base to emitter saturation voltage		$V_{BE(sat)}$	$I_C = 0.8\text{ A}, I_B = 0.16\text{ A}$			1.5	V
Transition frequency		f_T	$V_{CE} = 5\text{ V}, I_C = 0.15\text{ A}, f = 1\text{ MHz}$		10		MHz
Turn-on time		t_{on}	$I_C = 0.8\text{ A}, I_{B1} = 0.16\text{ A}, I_{B2} = -0.32\text{ A}$			0.7	μs
Storage time		t_{stg}	$V_{CC} = 250\text{ V}$			2.5	μs
Fall time		t_f				0.3	μs

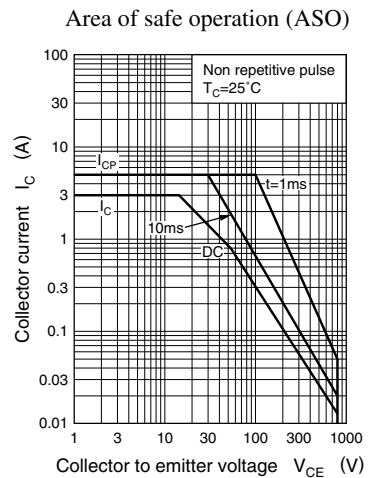
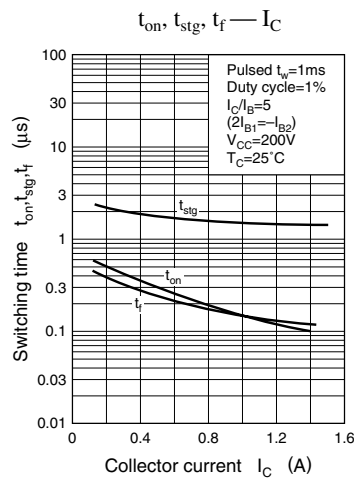
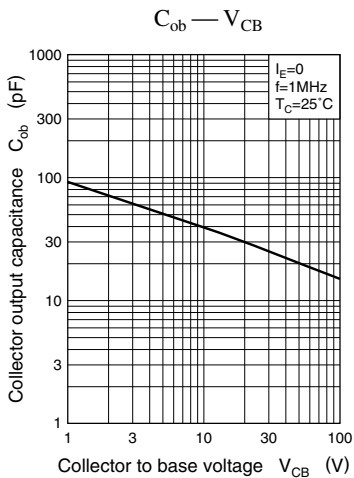
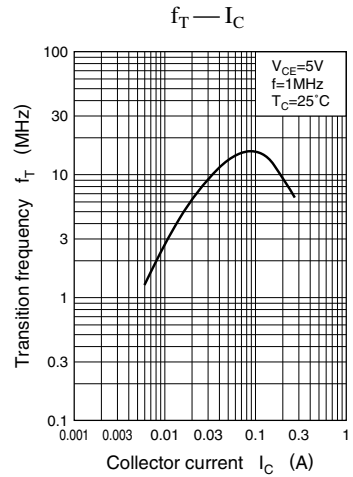
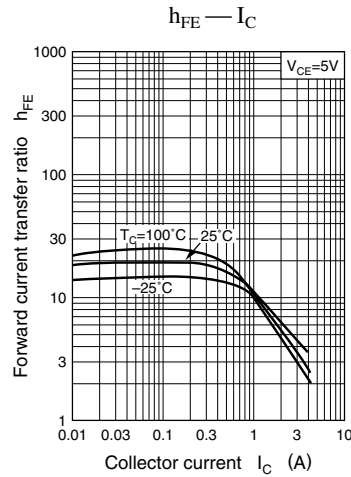
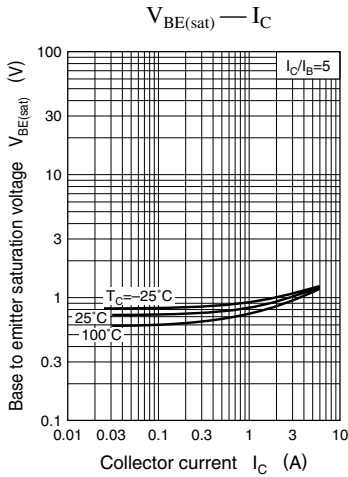
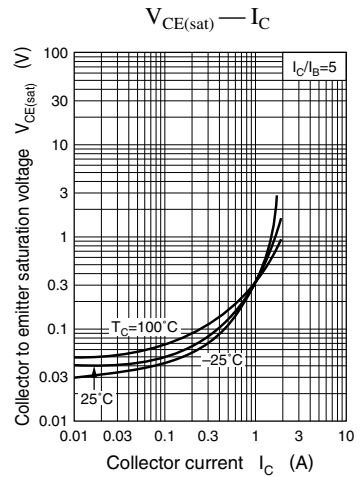
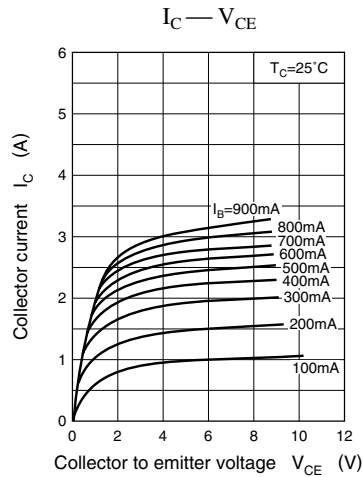
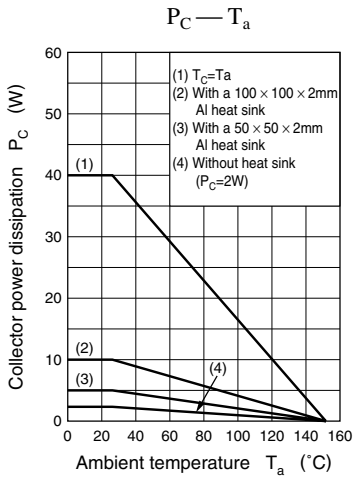

Area of safe operation, reverse bias ASO

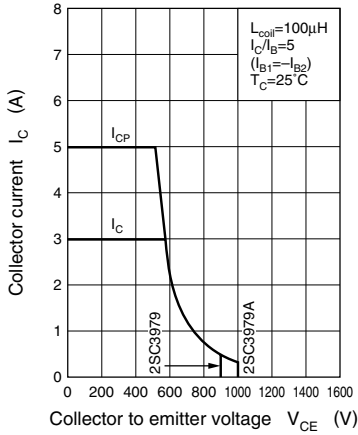

Reverse bias ASO measuring circuit

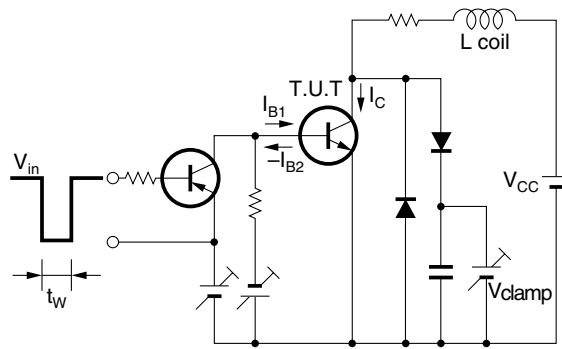

$R_{th(t)} - t$

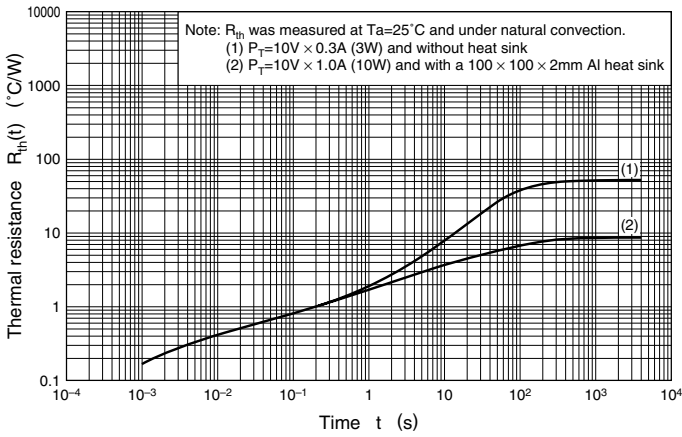

Request for your special attention and precautions in using the technical information and semiconductors described in this material

- (1) An export permit needs to be obtained from the competent authorities of the Japanese Government if any of the products or technologies described in this material and controlled under the "Foreign Exchange and Foreign Trade Law" is to be exported or taken out of Japan.
- (2) The technical information described in this material is limited to showing representative characteristics and applied circuit examples of the products. It does not constitute the warranting of industrial property, the granting of relative rights, or the granting of any license.
- (3) The products described in this material are intended to be used for standard applications or general electronic equipment (such as office equipment, communications equipment, measuring instruments and household appliances).
Consult our sales staff in advance for information on the following applications:
 - Special applications (such as for airplanes, aerospace, automobiles, traffic control equipment, combustion equipment, life support systems and safety devices) in which exceptional quality and reliability are required, or if the failure or malfunction of the products may directly jeopardize life or harm the human body.
 - Any applications other than the standard applications intended.
- (4) The products and product specifications described in this material are subject to change without notice for reasons of modification and/or improvement. At the final stage of your design, purchasing, or use of the products, therefore, ask for the most up-to-date Product Standards in advance to make sure that the latest specifications satisfy your requirements.
- (5) When designing your equipment, comply with the guaranteed values, in particular those of maximum rating, the range of operating power supply voltage and heat radiation characteristics. Otherwise, we will not be liable for any defect which may arise later in your equipment.
Even when the products are used within the guaranteed values, redundant design is recommended, so that such equipment may not violate relevant laws or regulations because of the function of our products.
- (6) When using products for which dry packing is required, observe the conditions (including shelf life and after-unpacking standby time) agreed upon when specification sheets are individually exchanged.
- (7) No part of this material may be reprinted or reproduced by any means without written permission from our company.

Please read the following notes before using the datasheets

- A. These materials are intended as a reference to assist customers with the selection of Panasonic semiconductor products best suited to their applications.
Due to modification or other reasons, any information contained in this material, such as available product types, technical data, and so on, is subject to change without notice.
Customers are advised to contact our semiconductor sales office and obtain the latest information before starting precise technical research and/or purchasing activities.
- B. Panasonic is endeavoring to continually improve the quality and reliability of these materials but there is always the possibility that further rectifications will be required in the future. Therefore, Panasonic will not assume any liability for any damages arising from any errors etc. that may appear in this material.
- C. These materials are solely intended for a customer's individual use.
Therefore, without the prior written approval of Panasonic, any other use such as reproducing, selling, or distributing this material to a third party, via the Internet or in any other way, is prohibited.