

## COMPLEMENTARY SILICON POWER TRANSISTORS

■ SGS-THOMSON PREFERRED SALESTYPES

**DESCRIPTION**

The BD909 and BD911 are silicon epitaxial-base NPN power transistors in Jedec TO-220 plastic package, intended for use in power linear and switching applications.

The complementary PNP types are BD910 and BD912 respectively.

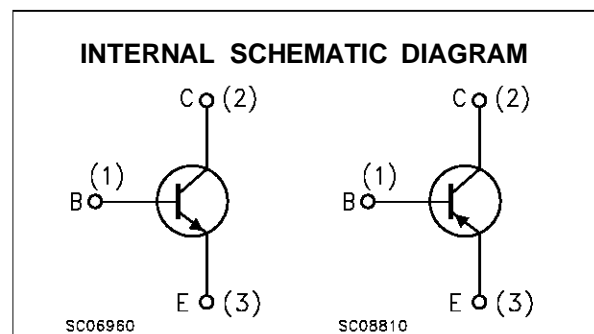
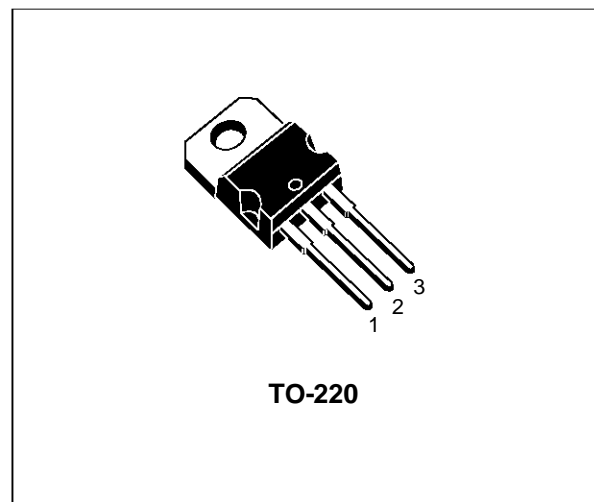

**ABSOLUTE MAXIMUM RATINGS**

Symbol	Parameter	Value		Unit	
		NPN	BD909		BD911
		PNP	BD910		BD912
$V_{CBO}$	Collector-Base Voltage ( $I_E = 0$ )		80	100	V
$V_{CEO}$	Collector-Emitter Voltage ( $I_B = 0$ )		80	100	V
$V_{EBO}$	Emitter-Base Voltage ( $I_C = 0$ )		5		V
$I_E, I_C$	Collector Current		15		A
$I_B$	Base Current		5		A
$P_{tot}$	Total Dissipation at $T_c \leq 25^\circ C$		90		W
$T_{stg}$	Storage Temperature		-65 to 150		$^\circ C$
$T_j$	Max. Operating Junction Temperature		150		$^\circ C$

For PNP types voltage and current values are negative.

# BD909/BD910/BD911/BD912

## THERMAL DATA

R <sub>thj-case</sub>	Thermal Resistance Junction-case	Max	1.4	°C/W
-----------------------	----------------------------------	-----	-----	------

## ELECTRICAL CHARACTERISTICS (T<sub>case</sub> = 25 °C unless otherwise specified)

Symbol	Parameter	Test Conditions	Min.	Typ.	Max.	Unit
I <sub>CBO</sub>	Collector Cut-off Current (I <sub>E</sub> = 0)	for <b>BD909/910</b> V <sub>CB</sub> = 80 V for <b>BD911/912</b> V <sub>CB</sub> = 100 V T <sub>case</sub> = 150 °C			500	μA
I <sub>CEO</sub>	Collector Cut-off Current (I <sub>B</sub> = 0)	for <b>BD909/910</b> V <sub>CB</sub> = 40 V for <b>BD911/912</b> V <sub>CB</sub> = 50 V			1	mA
I <sub>EBO</sub>	Emitter Cut-off Current (I <sub>C</sub> = 0)	V <sub>EB</sub> = 5 V			1	mA
V <sub>CEO(sus)*</sub>	Collector-Emitter Sustaining Voltage (I <sub>B</sub> = 0)	I <sub>C</sub> = 100 mA for <b>BD909/910</b> for <b>BD911/912</b>	80	100		V
V <sub>CE(sat)*</sub>	Collector-Emitter Saturation Voltage	I <sub>C</sub> = 5 A I <sub>B</sub> = 0.5 A I <sub>C</sub> = 10 A I <sub>B</sub> = 2.5 A			1	V
V <sub>BE(sat)*</sub>	Base-Emitter Saturation Voltage	I <sub>C</sub> = 10 A I <sub>B</sub> = 2.5 A			2.5	V
V <sub>BE*</sub>	Base-Emitter Voltage	I <sub>C</sub> = 5 A V <sub>CE</sub> = 4 V			1.5	V
h <sub>FE*</sub>	DC Current Gain	I <sub>C</sub> = 0.5 A V <sub>CE</sub> = 4 V I <sub>C</sub> = 5 A V <sub>CE</sub> = 4 V I <sub>C</sub> = 10 A V <sub>CE</sub> = 4 V	40	15	250	
f <sub>T</sub>	Transition frequency	I <sub>C</sub> = 0.5 A V <sub>CE</sub> = 4 V	3			MHz

\* Pulsed: Pulse duration = 300 μs, duty cycle 1.5 %  
 \*\* Value for which I<sub>C</sub> = 3.3 A at V<sub>CE</sub> = 2V.  
 For PNP types voltage and current values are negative.

## Safe Operating Area

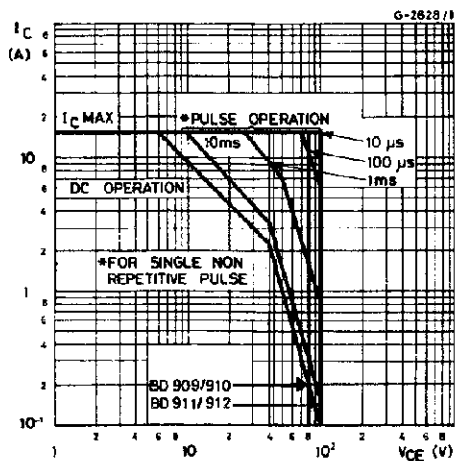

## Derating Curves

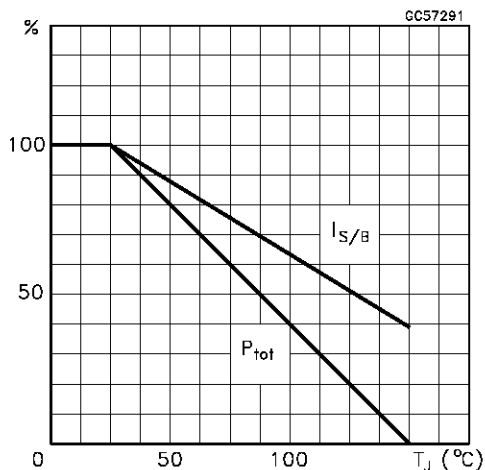

DC Current Gain (NPN type)

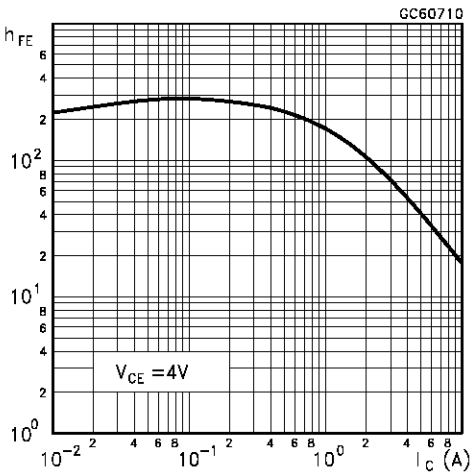

DC Current Gain (PNP type)

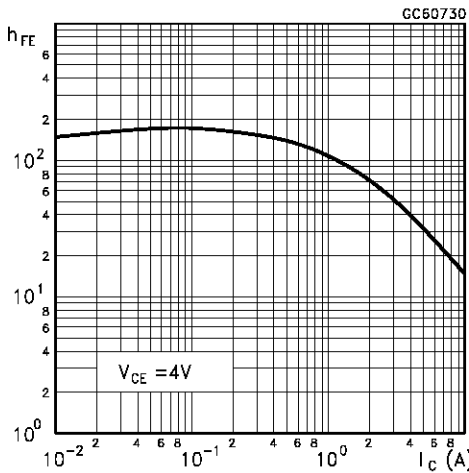

DC Transconductance (NPN type)

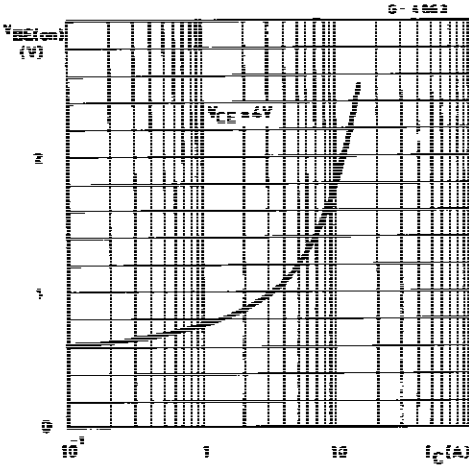

DC Transconductance (PNP type)

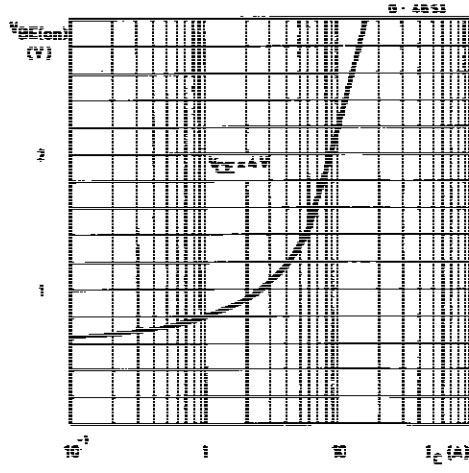

Collector-Emitter Saturation Voltage (NPN type)

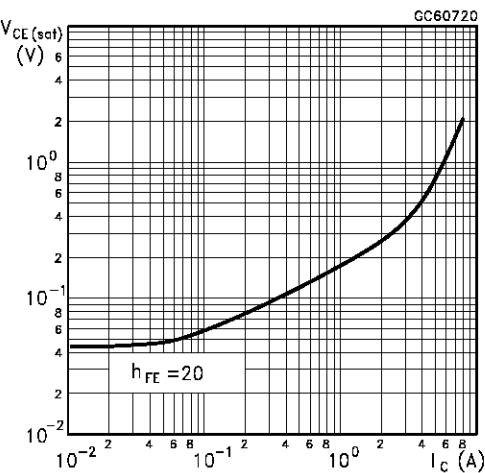

Collector-Emitter Saturation Voltage (PNP type)

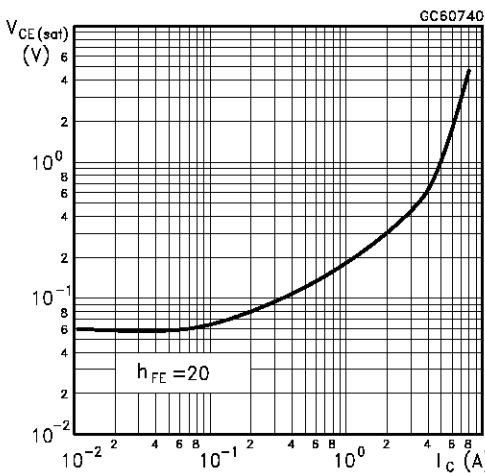

Base-Emitter Saturation Voltage (NPN type)

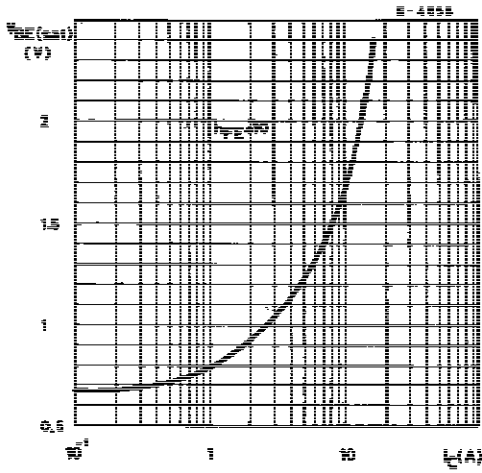

Base-Emitter Saturation Voltage (PNP type)

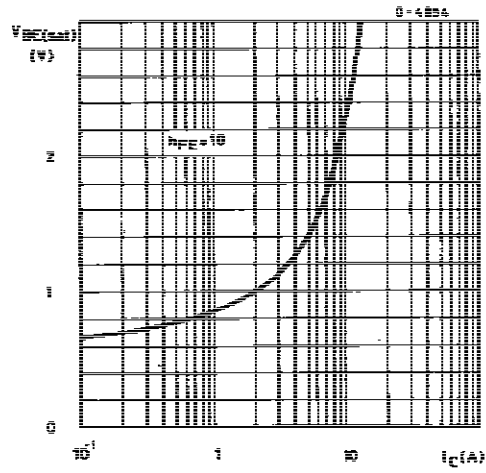

Transition Frequency (NPN type)

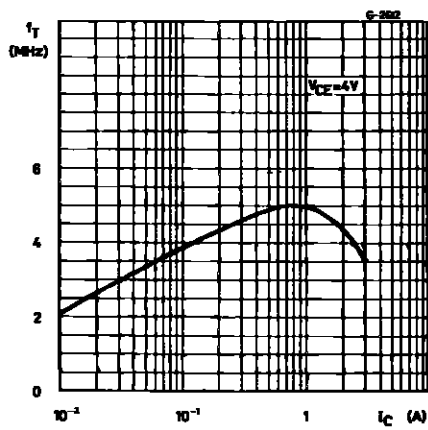

Transition Frequency (PNP type)

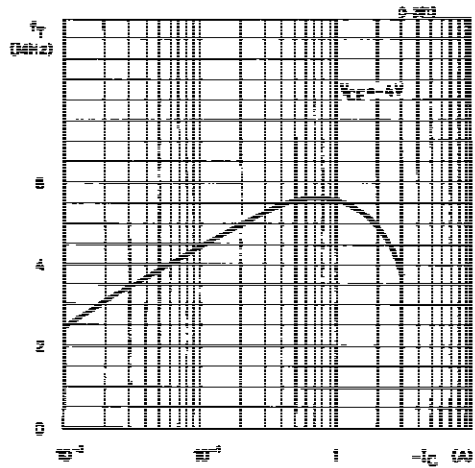

**TO-220 MECHANICAL DATA**

DIM.	mm			inch		
	MIN.	TYP.	MAX.	MIN.	TYP.	MAX.
A	4.40		4.60	0.173		0.181
C	1.23		1.32	0.048		0.051
D	2.40		2.72	0.094		0.107
D1		1.27			0.050	
E	0.49		0.70	0.019		0.027
F	0.61		0.88	0.024		0.034
F1	1.14		1.70	0.044		0.067
F2	1.14		1.70	0.044		0.067
G	4.95		5.15	0.194		0.203
G1	2.4		2.7	0.094		0.106
H2	10.0		10.40	0.393		0.409
L2		16.4			0.645	
L4	13.0		14.0	0.511		0.551
L5	2.65		2.95	0.104		0.116
L6	15.25		15.75	0.600		0.620
L7	6.2		6.6	0.244		0.260
L9	3.5		3.93	0.137		0.154
DIA.	3.75		3.85	0.147		0.151

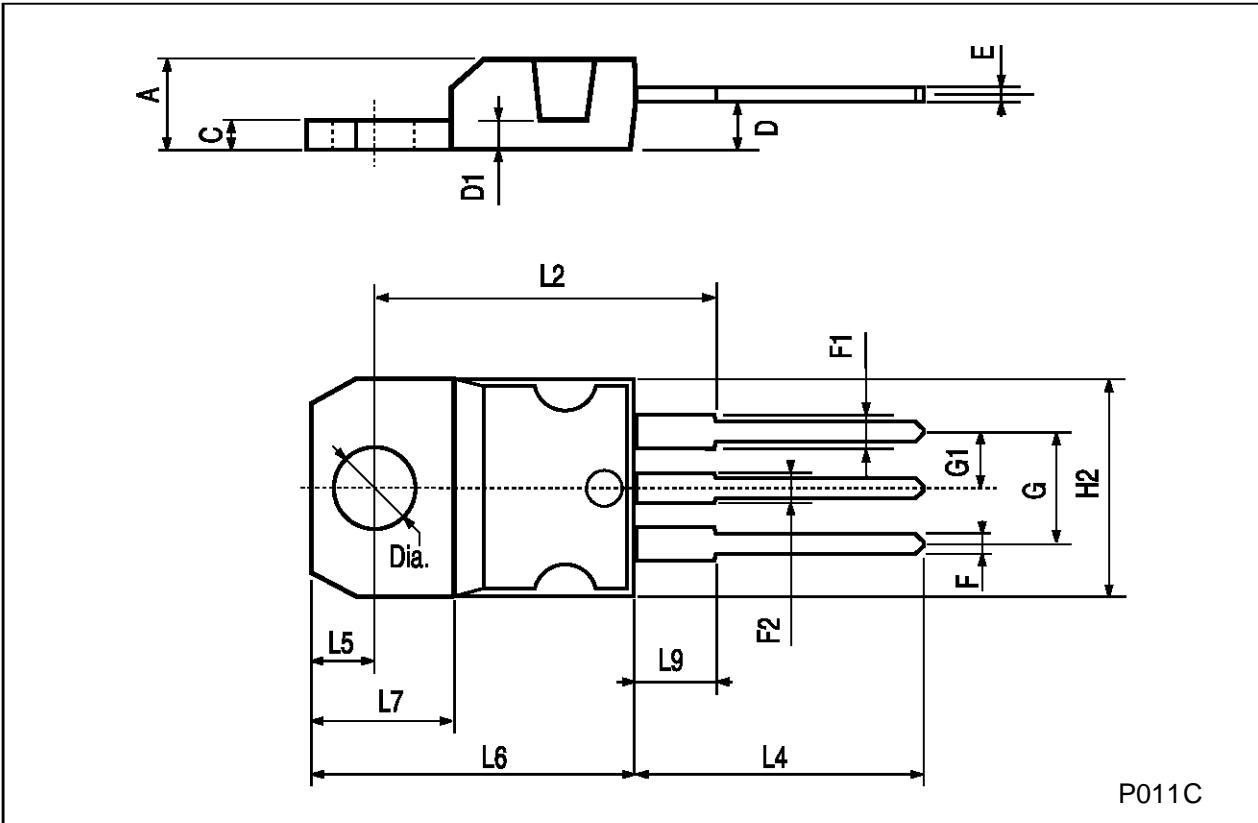

P011C

Information furnished is believed to be accurate and reliable. However, SGS-THOMSON Microelectronics assumes no responsibility for the consequences of use of such information nor for any infringement of patents or other rights of third parties which may result from its use. No license is granted by implication or otherwise under any patent or patent rights of SGS-THOMSON Microelectronics. Specifications mentioned in this publication are subject to change without notice. This publication supersedes and replaces all information previously supplied. SGS-THOMSON Microelectronics products are not authorized for use as critical components in life support devices or systems without express written approval of SGS-THOMSON Microelectronics.

© 1997 SGS-THOMSON Microelectronics - Printed in Italy - All Rights Reserved

SGS-THOMSON Microelectronics GROUP OF COMPANIES  
Australia - Brazil - Canada - China - France - Germany - Hong Kong - Italy - Japan - Korea - Malaysia - Malta - Morocco - The Netherlands -  
Singapore - Spain - Sweden - Switzerland - Taiwan - Thailand - United Kingdom - U.S.A

...