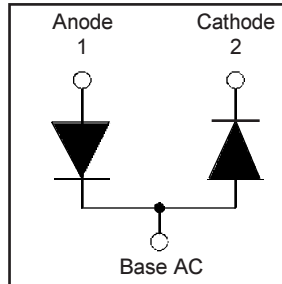


**Features**

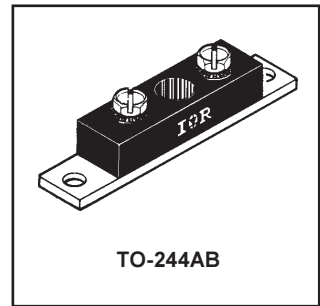
- Reduced RFI and EMI
- Reduced Snubbing
- Extensive Characterization of Recovery Parameters



$V_R = 600V$
$V_F(\text{typ.})^{\textcircled{3}} = 1.2V$
$I_{F(AV)} = 140A$
$Q_{rr}(\text{typ.}) = 340nC$
$I_{RRM}(\text{typ.}) = 8.5A$
$t_{rr}(\text{typ.}) = 33ns$
$di_{(rec)}/dt(\text{typ.})^{\textcircled{3}} = 220A/\mu s$

**Description**

HEXFRED™ diodes are optimized to reduce losses and EMI/RFI in high frequency power conditioning systems. An extensive characterization of the recovery behavior for different values of current, temperature and di/dt simplifies the calculations of losses in the operating conditions. The softness of the recovery eliminates the need for a snubber in most applications. These devices are ideally suited for power converters, motors drives and other applications where switching losses are significant portion of the total losses.



**Absolute Maximum Ratings (per Leg)**

	Parameter	Max.	Units
$V_R$	Cathode-to-Anode Voltage	600	V
$I_F @ T_C = 25^\circ C$	Continuous Forward Current	126	A
$I_F @ T_C = 100^\circ C$	Continuous Forward Current	63	
$I_{FSM}$	Single Pulse Forward Current <sup>①</sup>	400	
$E_{AS}$	Non-Repetitive Avalanche Energy <sup>②</sup>	220	$\mu J$
$P_D @ T_C = 25^\circ C$	Maximum Power Dissipation	310	W
$P_D @ T_C = 100^\circ C$	Maximum Power Dissipation	125	
$T_J$ $T_{STG}$	Operating Junction and Storage Temperature Range	-55 to +150	C

**Thermal - Mechanical Characteristics**

	Parameter	Min.	Typ.	Max.	Units
$R_{thJC}$	Junction-to-Case, Single Leg Conducting	—	—	0.48	$^\circ C/W$
	Junction-to-Case, Both Legs Conducting	—	—	0.24	$K/W$
$R_{thCS}$	Case-to-Sink, Flat, Greased Surface	—	0.10	—	
Wt	Weight	—	79 (2.8)	—	g (oz)
	Mounting Torque <sup>④</sup>	30 (3.4)	—	40 (4.6)	lbf·in (N·m)
	Mounting Torque Center Hole	12 (1.4)	—	18 (2.1)	
	Terminal Torque	30 (3.4)	—	40 (4.6)	
	Vertical Pull	—	—	80	lbf·in
	2 inch Lever Pull	—	—	35	

**Note:** <sup>①</sup> Limited by junction temperature  
<sup>②</sup> L = 100 $\mu H$ , duty cycle limited by max  $T_J$   
<sup>③</sup> 125 $^\circ C$

<sup>④</sup> Mounting surface must be smooth, flat, free of burrs or other protrusions. Apply a thin even film of thermal grease to mounting surface. Gradually tighten each mounting bolt in 5-10 lbf·in steps until desired or maximum torque limits are reached. Module

# HFA140NJ60D

PD-2.514 rev. A 02/99

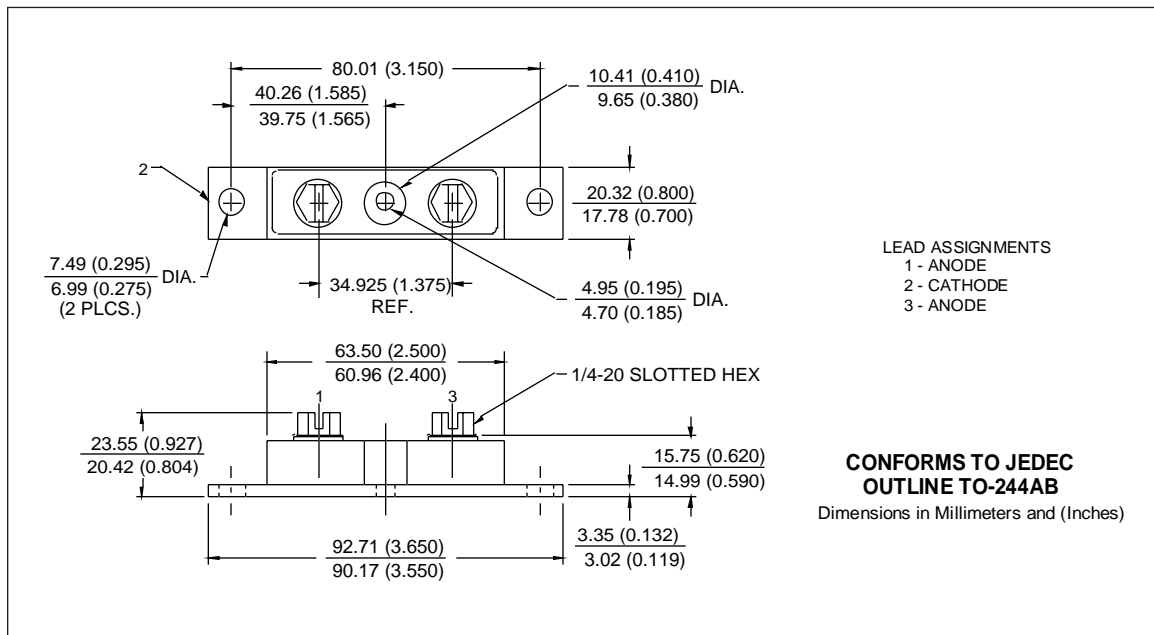
International  
**IOR** Rectifier

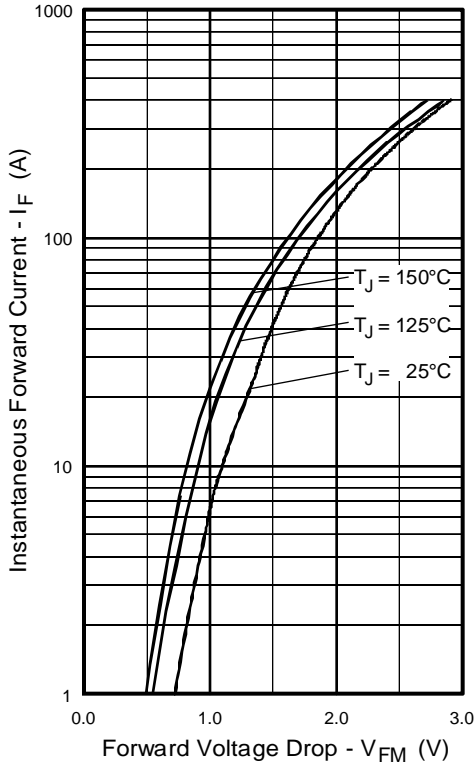
## Electrical Characteristics (per Leg) @ $T_J = 25^\circ\text{C}$ (unless otherwise specified)

Parameter	Min.	Typ.	Max.	Units	Test Conditions
$V_{BR}$ Cathode Anode Breakdown Voltage	600	—	—	V	$I_R = 100\mu\text{A}$
$V_{FM}$ Max Forward Voltage	—	1.3	1.5	V	$I_F = 70\text{A}$ $I_F = 140\text{A}$ $I_F = 70\text{A}, T_J = 125^\circ\text{C}$
	—	1.5	1.7		
	—	1.2	1.4		
$I_{RM}$ Max Reverse Leakage Current	—	4.0	20	$\mu\text{A}$	$V_R = V_R$ Rated $T_J = 125^\circ\text{C}, V_R = 480\text{V}$
	—	1.0	4.0	$\text{mA}$	
$C_T$ Junction Capacitance	—	140	250	$\text{pF}$	$V_R = 200\text{V}$
$L_S$ Series Inductance	—	7.0	—	$\text{nH}$	From top of terminal hole to mounting plane

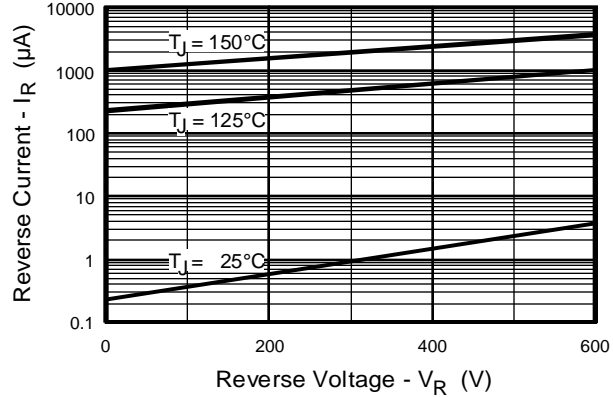
## Dynamic Recovery Characteristics (per Leg) @ $T_J = 25^\circ\text{C}$ (unless otherwise specified)

Parameter	Min.	Typ.	Max.	Units	Test Conditions
$t_{rr}$ Reverse Recovery Time	—	33	—	ns	$I_F = 1.0\text{A}, di/dt = 200\text{A}/\mu\text{s}, V_R = 30\text{V}$ $T_J = 25^\circ\text{C}$ $T_J = 125^\circ\text{C}$
$t_{rr1}$	—	80	120		
$t_{rr2}$	—	140	220		
$I_{RRM1}$ Peak Recovery Current	—	8.5	15	A	$T_J = 25^\circ\text{C}$ $T_J = 125^\circ\text{C}$
	$I_{RRM2}$	—	14		
$Q_{rr1}$ Reverse Recovery Charge	—	340	900	nC	$T_J = 25^\circ\text{C}$ $T_J = 125^\circ\text{C}$
	$Q_{rr2}$	—	980		
$di_{(rec)M}/dt1$ Peak Rate of Fall of Recovery Current	—	300	—	$\text{A}/\mu\text{s}$	$T_J = 25^\circ\text{C}$ $T_J = 125^\circ\text{C}$
$di_{(rec)M}/dt2$ During $t_b$	—	220	—		

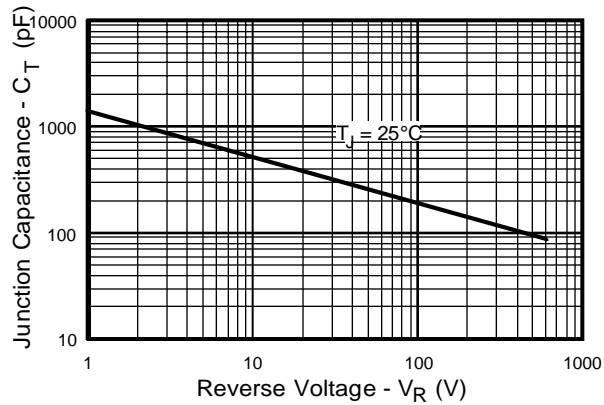




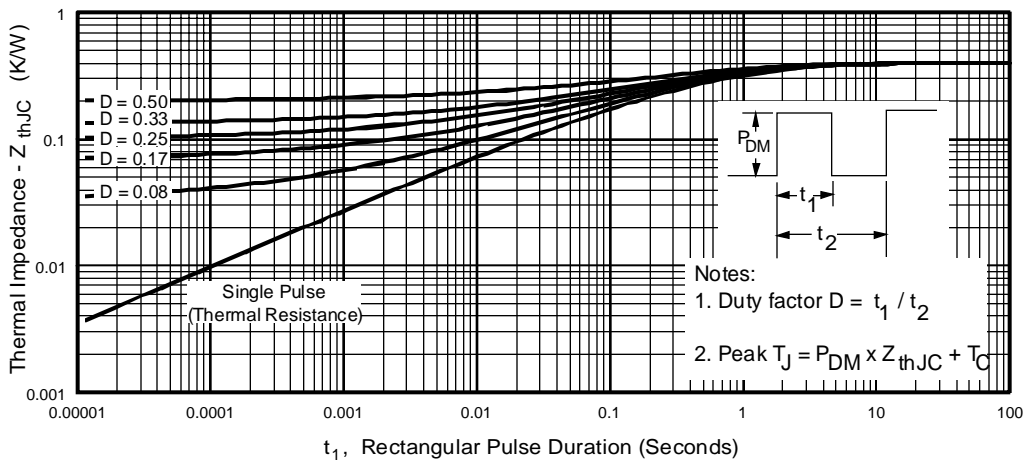
**Fig. 1** - Maximum Forward Voltage Drop vs. Instantaneous Forward Current, (per Leg)



**Fig. 2** - Typical Reverse Current vs. Reverse Voltage, (per Leg)



**Fig. 3** - Typical Junction Capacitance vs. Reverse Voltage, (per Leg)

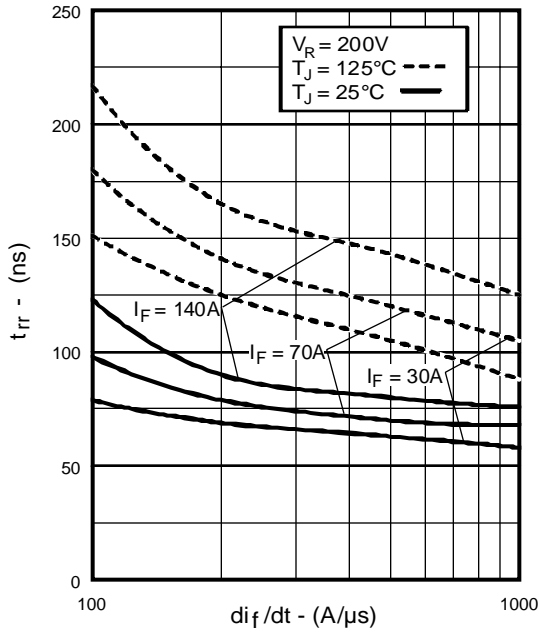


**Fig. 4** - Maximum Thermal Impedance  $Z_{thJC}$  Characteristics, (per Leg)

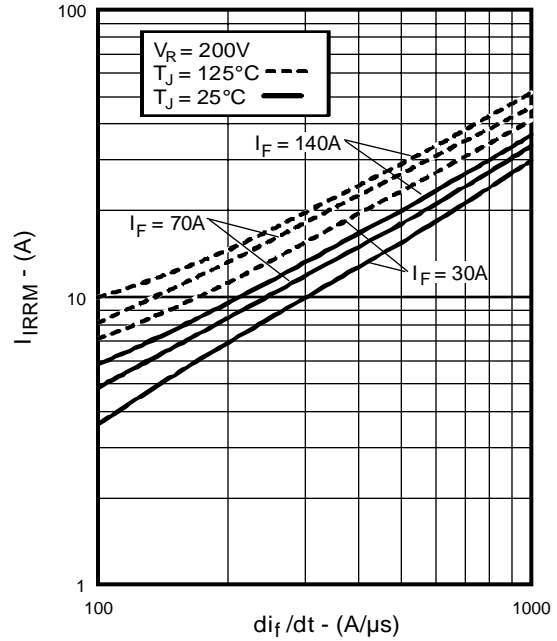
# HFA140NJ60D

PD-2.514 rev. A 02/99

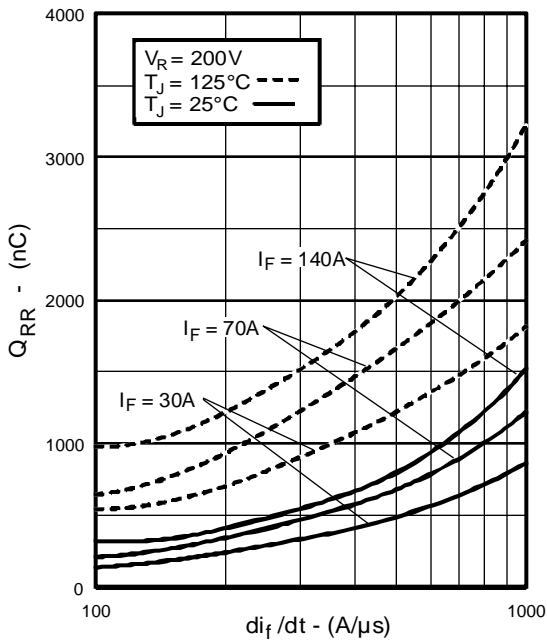
International  
IOR Rectifier



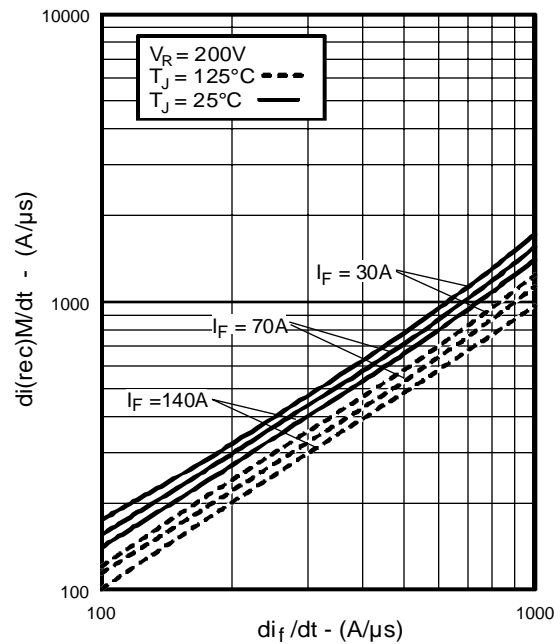
**Fig. 5** - Typical Reverse Recovery vs.  $di_f/dt$ , (per Leg)



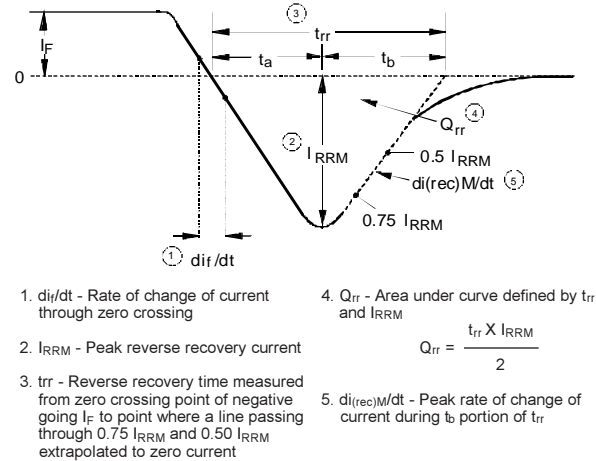
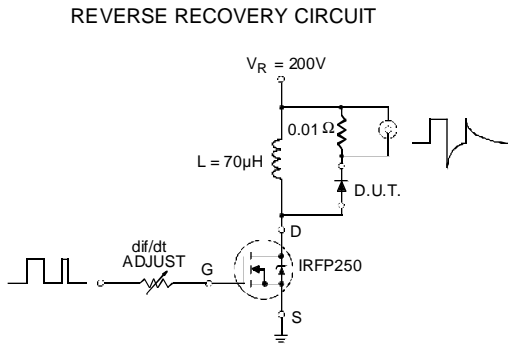
**Fig. 6** - Typical Recovery Current vs.  $di_f/dt$ , (per Leg)



**Fig. 7** - Typical Stored Charge vs.  $di_f/dt$ , (per Leg)

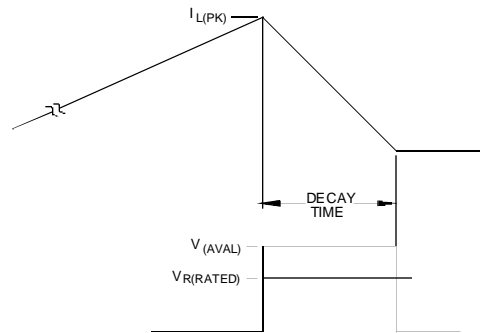
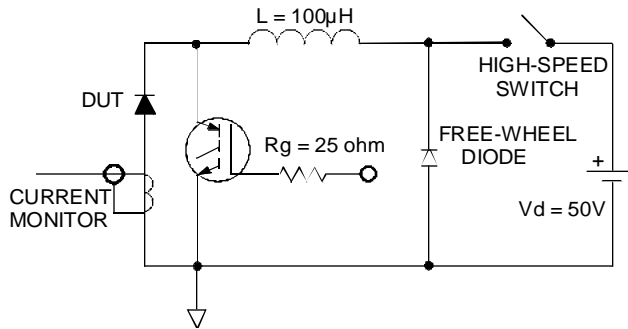


**Fig. 8** - Typical  $di_{(rec)M}/dt$  vs.  $di_f/dt$ , (per Leg)



**Fig. 9 - Reverse Recovery Parameter Test Circuit**

**Fig. 10 - Reverse Recovery Waveform and Definitions**



**Fig. 11 - Avalanche Test Circuit and Waveforms**