



## N-Channel 80- and 90-V (D-S) MOSFETs

PRODUCT SUMMARY				
Part Number	V <sub>(BR)DSS</sub> Min (V)	r <sub>DS(on)</sub> Max (Ω)	V <sub>GS(th)</sub> (V)	I <sub>D</sub> (A)
VN0808L	80	4 @ V <sub>GS</sub> = 10 V	0.8 to 2	0.3
VN0808LS		4 @ V <sub>GS</sub> = 10 V	0.8 to 2	0.33
VQ1006P	90	4 @ V <sub>GS</sub> = 10 V	0.8 to 2.5	0.4

### FEATURES

- Low On-Resistance: 3.6 Ω
- Low Threshold: 1.6 V
- Low Input Capacitance: 35 pF
- Fast Switching Speed: 6 ns
- Low Input and Output Leakage

### BENEFITS

- Low Offset Voltage
- Low-Voltage Operation
- Easily Driven Without Buffer
- High-Speed Circuits
- Low Error Voltage

### APPLICATIONS

- Direct Logic-Level Interface: TTL/CMOS
- Drivers: Relays, Solenoids, Lamps, Hammers, Displays, Memories, Transistors, etc.
- Battery Operated Systems
- Solid-State Relays

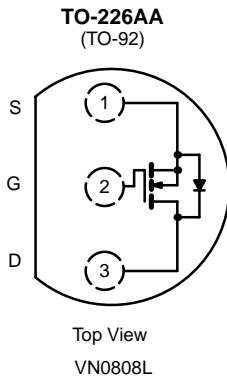

Front View:  
VN0808L

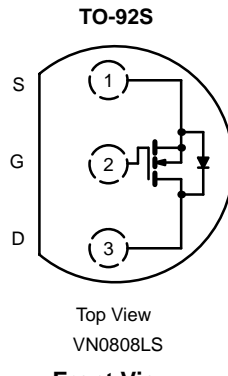
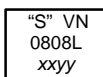

Front View:

VN0808LS

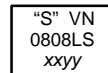

"S" = Siliconix Logo  
f = Factory Code  
// = Lot Traceability  
xxyy = Date Code

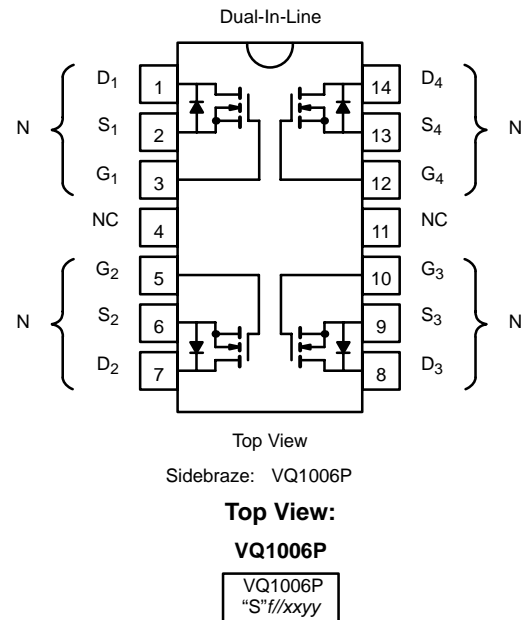

### ABSOLUTE MAXIMUM RATINGS (T<sub>A</sub> = 25°C UNLESS OTHERWISE NOTED)

Parameter	Symbol	VN0808L	VN0808LS	VQ1006P		Unit	
				Single	Total Quad		
Drain-Source Voltage	V <sub>DS</sub>	80	80	90		V	
Gate-Source Voltage	V <sub>GS</sub>	±30	±30	±20			
Continuous Drain Current (T <sub>J</sub> = 150°C)	I <sub>D</sub>	T <sub>A</sub> = 25°C	0.3	0.33	0.4	A	
		T <sub>A</sub> = 100°C	0.19	0.21	0.23		
Pulsed Drain Current <sup>a</sup>	I <sub>DM</sub>	1.9	1.9	2			
Power Dissipation	P <sub>D</sub>	T <sub>A</sub> = 25°C	0.8	0.9	1.3	2	W
		T <sub>A</sub> = 100°C	0.32	0.4	0.52	0.8	
Thermal Resistance, Junction-to-Ambient	R <sub>thJA</sub>	156	139	96	62.5	°C/W	
Operating Junction and Storage Temperature Range	T <sub>J</sub> , T <sub>stg</sub>	-55 to 150					°C

Notes

a. Pulse width limited by maximum junction temperature.



SPECIFICATIONS (T <sub>A</sub> = 25 °C UNLESS OTHERWISE NOTED)								
Parameter	Symbol	Test Conditions	Typ <sup>a</sup>	Limits				Unit
				VN0808L/LS		VQ1006P		
				Min	Max	Min	Max	
<b>Static</b>								
Drain-Source Breakdown Voltage	V <sub>(BR)DSS</sub>	V <sub>GS</sub> = 0 V, I <sub>D</sub> = 10 μA	125	80		90		V
Gate-Threshold Voltage	V <sub>GS(th)</sub>	V <sub>DS</sub> = V <sub>GS</sub> , I <sub>D</sub> = 1 mA	1.6	0.8	2	0.8	2.5	
Gate-Body Leakage	I <sub>GSS</sub>	V <sub>DS</sub> = 0 V, V <sub>GS</sub> = ±15 V			±100		±100	nA
							±500	
Zero Gate Voltage Drain Current	I <sub>DSS</sub>	V <sub>DS</sub> = 80 V, V <sub>GS</sub> = 0 V			10			μA
					500			
							1	
		V <sub>DS</sub> = 72 V, V <sub>GS</sub> = 0 V					500	
		T <sub>J</sub> = 125 °C						
On-State Drain Current <sup>b</sup>	I <sub>D(on)</sub>	V <sub>DS</sub> = 10 V, V <sub>GS</sub> = 10 V	1.8	1.5		1.5		A
Drain-Source On-Resistance <sup>b</sup>	r <sub>DS(on)</sub>	V <sub>GS</sub> = 5 V, I <sub>D</sub> = 0.3 A	3.8				5	Ω
					4		4.5	
					8		8.6	
		T <sub>J</sub> = 125 °C	6.7					
Forward Transconductance <sup>b</sup>	g <sub>fs</sub>	V <sub>DS</sub> = 10 V, I <sub>D</sub> = 0.5 A	350	170		170		mS
Common Source Output Conductance <sup>b</sup>	g <sub>os</sub>	V <sub>DS</sub> = 10 V, I <sub>D</sub> = 0.1 A	0.23					
<b>Dynamic</b>								
Input Capacitance	C <sub>iss</sub>	V <sub>DS</sub> = 25 V, V <sub>GS</sub> = 0 V, f = 1 MHz	35		50		60	pF
Output Capacitance	C <sub>oss</sub>		15		40		50	
Reverse Transfer Capacitance	C <sub>rss</sub>		2		10		10	
<b>Switching<sup>c</sup></b>								
Turn-On Time	t <sub>ON</sub>	V <sub>DD</sub> = 25 V, R <sub>L</sub> = 23 Ω I <sub>D</sub> ≅ 1 A, V <sub>GEN</sub> = 10 V R <sub>G</sub> = 25 Ω	6		10		10	ns
Turn-Off Time	t <sub>OFF</sub>		8		10		10	

**Notes**

- a. For DESIGN AID ONLY, not subject to production testing..
- b. Pulse test: PW ≤ 300 μs duty cycle ≤ 2%.
- c. Switching time is essentially independent of operating temperature.

VNDQ09



**TYPICAL CHARACTERISTICS ( $T_A = 25^\circ\text{C}$  UNLESS OTHERWISE NOTED)**

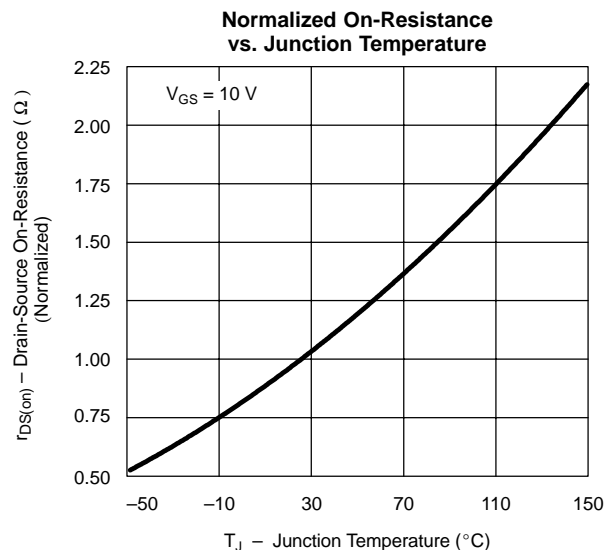
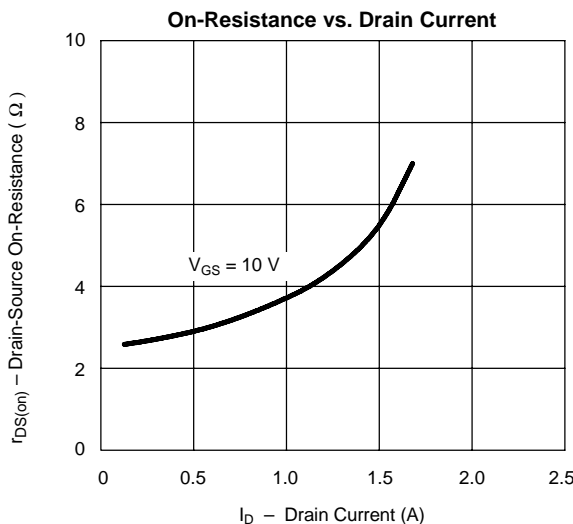
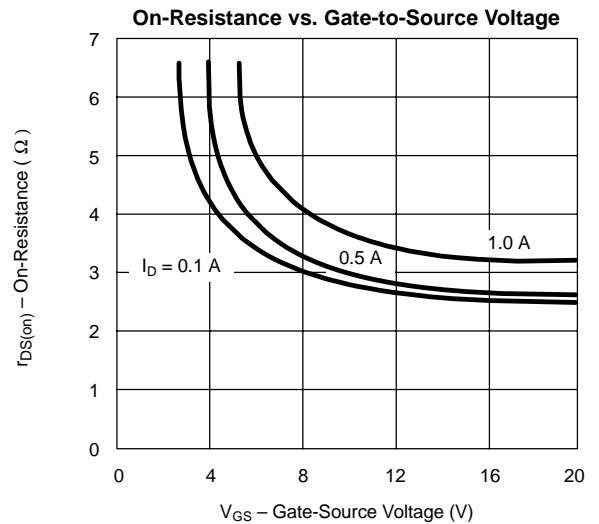
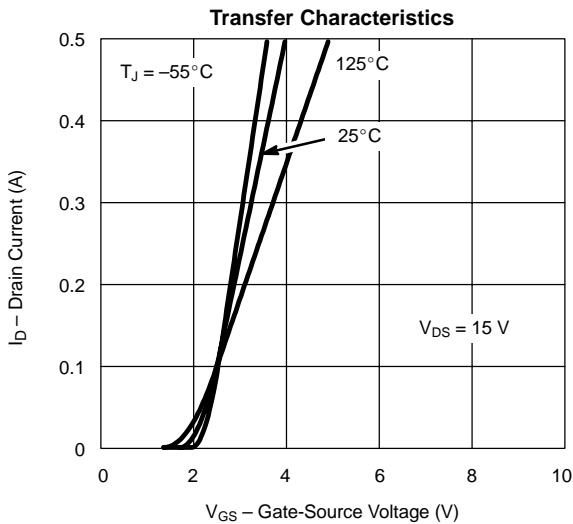
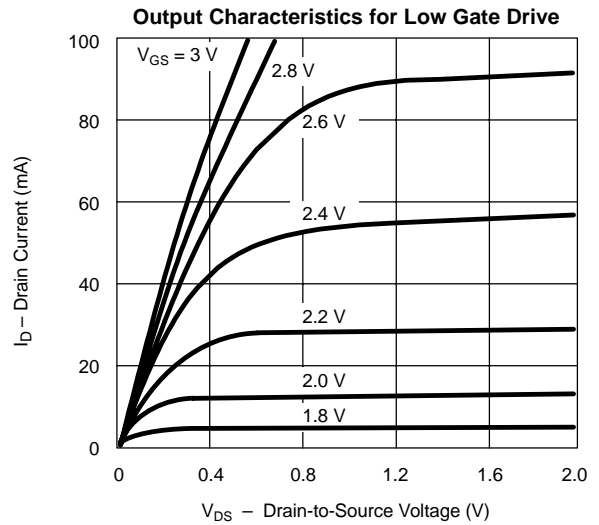
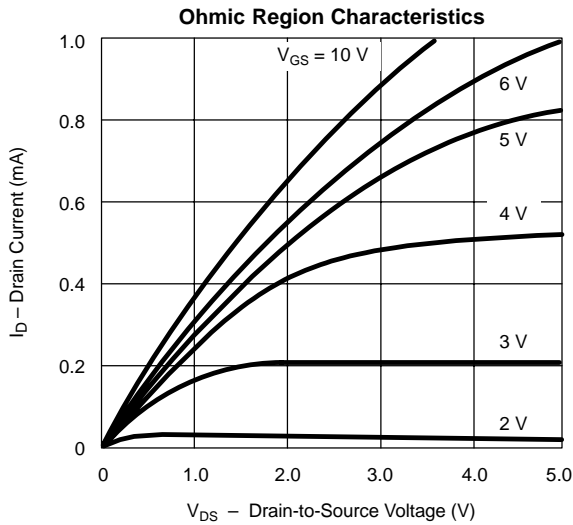

**TYPICAL CHARACTERISTICS ( $T_A = 25^\circ\text{C}$  UNLESS OTHERWISE NOTED)**

