

KA3502

PC SMPS Supervisory IC

Features

- Complete Housekeeping Circuit
- Few External Components
- Over Voltage Protection for 3.3V/5V/12V/Adj. Output
- Over Current Protection for 3.3V/5V/12V Output
- Open-Collector Output and Remote On/Off Function
- Remote On/Off Delay Time Control
- Precision Voltage Reference for Outputs, 5V/12V
- Uncommitment Precision Voltage Reference for +5Vs
- Power Good Signal Generator with Hysteresis
- Disable Logic of 3.3V, 5V, 12V for Complete Shutdown

Descriptions

The KA3502 is complete housekeeping circuitry for use in the secondary side of SMPS(Switched Mode Power Supply). It contains various functions, which are two Precision Voltage References, Over Voltage/Current Protection, Remote On/Off Control, Power Good Signal Generator, Disable Logic and etc.

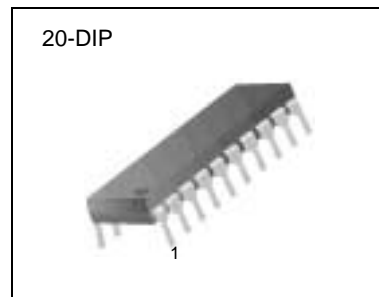

Internal Block Diagram

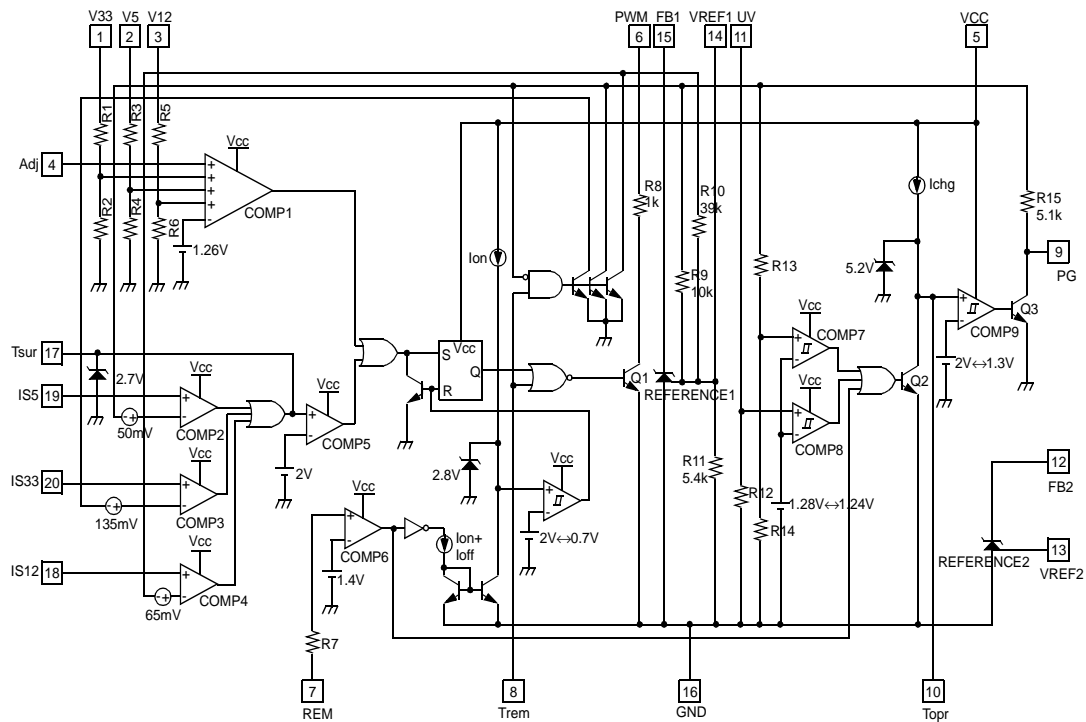

Pin Assignments

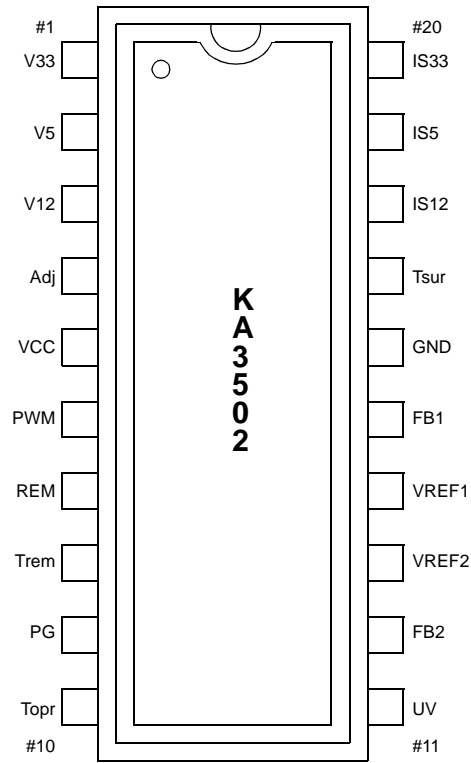

NO	NAME	FUNCTION	NO	NAME	FUNCTION
1	V33	+3.3 V OUTPUT VOLTAGE	11	UV	PG INPUT for Det
2	V5	+5 V OUTPUT VOLTAGE	12	FB2	FEEDBACK for REFERENCE 2
3	V12	+12 V OUTPUT VOLTAGE	13	VREF2	PRECISION REFERENCE
4	Adj	ADJUSTABLE OVP INPUT	14	VREF1	PRECISION REFERENCE
5	VCC	SUPPLY VOLTAGE	15	FB1	FEEDBACK for REFERENCE 1
6	PWM	REMOTE ON/OFF OUTPUT	16	GND	GROUND
7	REM	REMOTE ON/OFF INPUT	17	Tsur	OCP DELAY
8	Trem	REMOTE ON/OFF DELAY	18	IS12	Current INPUT for +12V
9	PG	POWER GOOD OUTPUT	19	IS5	Current INPUT for +5V
10	Topr	PG DELAY	20	IS33	Current INPUT for +3.3V

Pin Description

Pin Number	Pin Name	Pin Function Description
1	V33	+3.3 V Output Voltage of SMPS Secondary side
2	V5	+5 V Output Voltage of SMPS Secondary side
3	V12	+12 V Output Voltage of SMPS Secondary side
4	ADJ	Adjustable OVP Input. Its Threshold Voltage is 1.26 V. This pin can be used for another protection signal.
5	VCC	Supply Voltage. Operating range is 15 V ~ 24 V. Vcc=18 V, Ta=25°C at test.
6	PWM	Remote On/Off Output. This signal controls the primary power switch (PWM IC) through an Opto-coupler. Maximum current rating is 30 mA. When PWM="Low", the main SMPS is operational and If PWM="High", the main SMPS is turned-off.
7	REM	Remote On/Off Input. It is TTL operation and its threshold voltage is 1.4 V. Voltage at this pin can reach normally 4.6 V, with absolutely maximum voltage, 5.25 V. If REM="Low", PWM="Low". That means the main SMPS is operational. When REM="High", then PWM="High" and the main SMPS is turned-off.
8	Trem	Remote On/Off delay. Ton/Toff=8 ms/24 ms (Typ.) with Ctrem=0.1uF. Its High/Low threshold voltage is 2 V/0.7 V and the maximum voltage after full charging is about 2.8 V. So, ΔV (Chg.) = 2 V, ΔV (Dischg.) = 2.1 V Typ.
9	PG	Power Good output signal. PG="High" means that the power is "Good" for operation and PG="Low" means "Power Fail".
10	Topr	PG Delay. Td=250 ms (Typ.) with Ctopr=2.2uF. The High/Low threshold voltage are 2 V/1.3 V and the voltage of PIN 10 is clamped at 5.2 V for Noise margin.
11	UV	Under-Voltage Detect Pin. Its threshold voltage is 1.26V \pm 20mV Typ.
12	FB2	Feedback for Precision Reference2. Absolute min/max current rating is 1 mA/30 mA.
13	VREF2	Precision Reference 2 input Voltage. This circuit equals to KA431 and it is designed for an Auxiliary voltage, +5 Vs. It is trimmed to \pm 1.6%.
14	VREF1	Precision Reference 1 Input Voltage. This circuit equals to KA431 and it is for corrective output voltages of +5 V/+12 V. It's trimmed to \pm 1.6%.
15	FB1	Feedback for Precision Reference1. Absolute min/max current rating is 2 mA/30 mA because of internal connection.
16	GND	Ground
17	Tsur	Timing pin for Over Current Protection blank-out time. Its threshold voltage is 2 V and clamped at 2.7 V after full charging. Target of delay time is 20 ms~30 ms and it is realized through external R & C.
18	IS12	Current Sense Input for +12V. This pin is connected to the Current Sensing resistor or inductor. If the voltage drop of the resistor or inductor is larger than the fixed offset voltage (65 mV Typ.), PWM becomes "High" after some delay and the main SMPS is turned-off.
19	IS5	Current Sense Input for +5 V. The OCP Offset voltage for +5 V is 50 mV
20	IS33	Current Sense Input for +3.3 V. The OCP Offset voltage for +3.3 V is 135 mV

Absolute Maximum Ratings

Parameter	Symbol	Value	Unit
Supply Voltage	V _{cc}	15 ~ 24	V
UV Input Voltage	V _{uv}	24	V
Input Maximum Voltage	V _{in (max)}	V _{cc} - 3	V
Cathode Current for FB1, 2	I _{k1, 2}	1 ~ 30	mA
PWM Maximum Current	I _{o (PWM)}	30	mA
PG Output Maximum Current	I _{o (PG)}	30	mA
Power Dissipation	P _d	1	W
Operating Temperature Range	T _{opr}	0 ~ 70	°C
Storage Temperature Range	T _{stg}	-65 ~ 150	°C

Temperature Characteristics

Parameter	Symbol	Value	Unit
Temperature Stability for V _{ref1, 2} (0°C ≤ T _a ≤ 70°C)	ΔV _{ref1, 2}	17	mV

Electrical Characteristics (V_{cc} = 18V, T_a = 25°C)

Parameter	Symbol	Condition	Min.	Typ.	Max.	Unit
PROTECTION SECTION						
Over Voltage Protection For 3.3 V	Vovp33	Pin 7 (REM)=0V	3.8	4.0	4.2	V
Over Voltage Protection For 5 V	Vovp5	Pin 7 (REM)=0V	5.8	6.1	6.4	V
Over Voltage Protection For 12 V	Vovp12	Pin 7 (REM)=0V	13.4	14.2	15.0	V
OVP Input Threshold Voltage for Adj	Vadj	Pin 7 (REM)=0V	1.22	1.26	1.30	V
Comparator Offset Voltage for 3.3 V	Vos33	Pin 7 (REM)=0V	125.5	135	144.5	mV
Comparator Offset Voltage for 5 V	Vos5	Pin 7 (REM)=0V	46.5	50	53.5	mV
Comparator Offset Voltage for 12 V	Vos12	Pin 7 (REM)=0V	60.5	65	69.5	mV
OCP Delay Comparator Input Threshold Voltage	Vth (Tsur)	Pin 7 (REM)=0V	1.9	2	2.1	V
Pin 17 (Tsur) Input Clamp Voltage	V17max	Pin 7 (REM)=0V	-	2.7	4	V
REMOTE ON/OFF SECTION						
Remote On/off Input Threshold Vtg.	Vth	Pin 7 (REM): "L"→"H"	1	-	1.8	V
Remote On/off Input Open Voltage	Vih	Pin 7 Open	4	-	5.25	V
Remote On/off Input Low Current	Iil	Pin 7 (REM)=0 V	0	-	-1.0	mA
ON Delay Time	Ton	REM: "L"→"H", C=0.1 uF	4	8	14	msec
OFF Delay Time	Toff	REM: "L"→"H", C=0.1 uF	16	24	34	msec
PWM Saturation Voltage	Vsat (PWM)	I _o =0.5 mA	-	-	1.3	V
PWM Leakage Current	Ileak	Pin 6 (PWM)=20 V	-	0.01	1	uA
REFERENCE 1 SECTION						
Reference Input Voltage 1	Vref1	I _{lk1} =1 mA	2.46	2.50	2.54	V
Line Regulation 1	Vref1 (line)	15 V<V _{cc} <20 V	-	1	-	mV/V
Current Stability 1	Δ Vref1	I _{lk1} =1 mA to 10 mA	-	5	20	mV
Output Sinking Current Capability 1	I _{sink1}	-	15	25	-	mA
Absolute Precision of Internal Three Resistors	R _{int}	-	-	± 15	-	%
Matching Coefficient of Internal Three Resistors	R _{rate}	-	-	± 1	-	%
Temperature Stability	Δ Vref1	T _a =0 to 70°C (Note 1)	-	13	17	mV
Gain Bandwidth 1	GBW1	GV=1 (Note 1)	-	1	-	MHz

Electrical Characteristics (Continued)

Parameter	Symbol	Condition	Min.	Typ.	Max.	Unit
REFERENCE 2 SECTION						
Reference Input Voltage 2	Vref2	I _{lk2} =1 mA	2.46	2.50	2.54	V
Line Regulation 2	Vref2 (line)	15 V<V _{cc} <20 V	-	1	-	mV/V
Current Stability 2	Δ Vref2	I _{lk2} mA to 10 mA	-	5	20	mV
Output Sinking Current Capability 2	I _{sink2}	-	15	25	-	mA
Temperature Stability 2	Δ Vref2	T _a =0 to 70°C (Note 1)	-	13	17	mV
Gain Bandwidth 2	GBW2	GV=1 (Note 1)	-	1	-	MHz
POWER GOOD SECTION						
Detecting UV Voltage	V _{uv}	Pin 7 (REM)=0V	1.22	1.26	1.30	V
Detecting V5 Voltage	V _{in} (V5)	Pin 7 (REM)=0V	4.1	4.3	4.5	V
Hysteresis Voltage 1	HY1	Pin 11 (UV): "L"↔"H"	20	40	80	mV
Hysteresis Voltage 2	HY2	Pin 10 (Topr): "L"↔"H"	0.2	0.7	-	V
High Threshold Voltage of Comp 9	V _{th} (H)	Pin 10 (Topr): "L"↔"H"	1.8	2.0	2.2	V
Noise margin of V _{topr}	Δ V _{topr}	V _{topr} (max) - V _{th} (L)	2	4	-	V
Charging Current for PG Delay	I _{chg}	Pin 10 (Topr)=GND	-12	-18	-28	uA
Turn-On Delay Time for PG	Topr	C _{topr} =2.2uF	100	250	500	msec
UV Input Pull Down Resistor	R _{uv}	-	-	20	-	kohm
PG Output Rising Time	T _r	C=0.1nF (Note 1)	-	1	-	usec
PG Output Falling Time	T _f	C=0.1nF (Note 1)	-	300	-	nsec
PG Output Saturation Voltage	V _{sat} (PG)	I _{sink} =15 mA	-	0.3	0.4	V
PG Output Voltage at High Status	V _{pgh}	I _{source} =100 uA	4.2	-	5.25	V
DISABLE SECTION						
Disable Saturation Voltage for V33	V _{dis33}	REM=2 V, I _{sink} =10 mA	-	0.2	0.4	V
Disable Saturation Voltage for V5	V _{di5}	REM=2 V, I _{sink} =10 mA	-	0.2	0.4	V
Disable Saturation Voltage for V12	V _{dis12}	REM=2 V, I _{sink} =10 mA	-	0.2	0.4	V
TOTAL STANDBY CURRENT						
Supply Current Of V _{cc}	I _{cc}	V _{cc} =18 V, REM=2V	-	5	10	mA

Note:

1. These parameters, although guaranteed, but not 100% tested in production.

Typical Characteristics

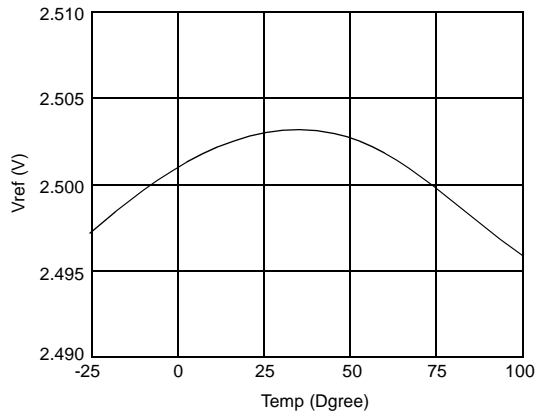

Figure 1. Temperature Stability for Vref1,2

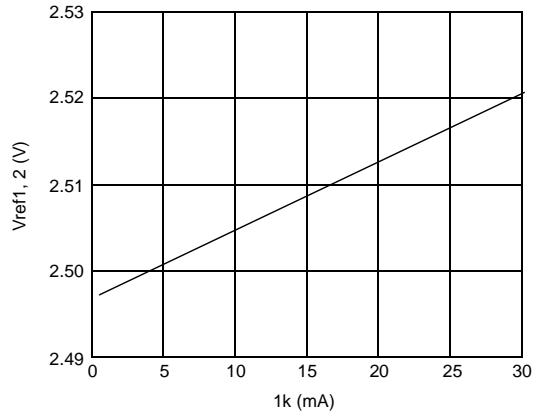

Figure 2. Vref1,2 Current Stability

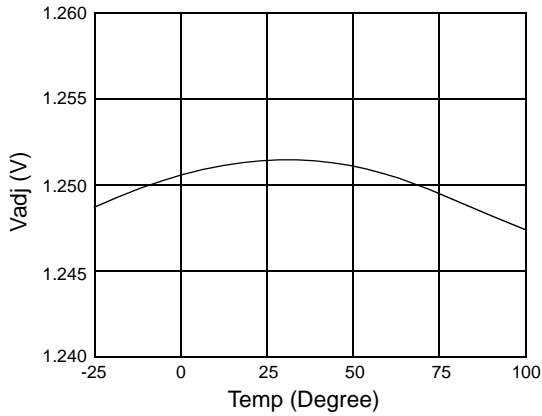

Figure 3. Bandgap Voltage (Vadj)

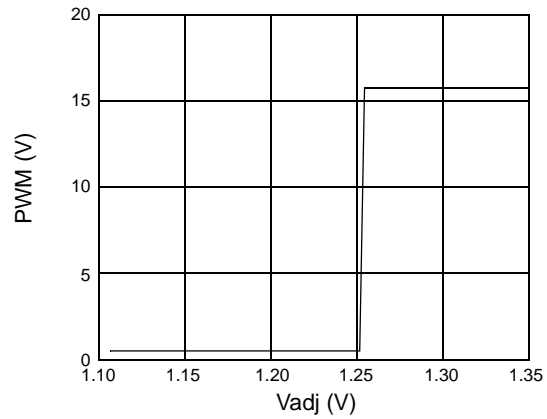

Figure 4. OVP Input Threshold Voltage for Adj

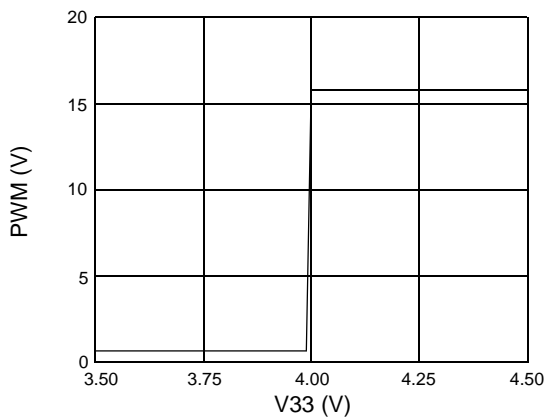

Figure 3. Over Voltage Protection for +3.3V

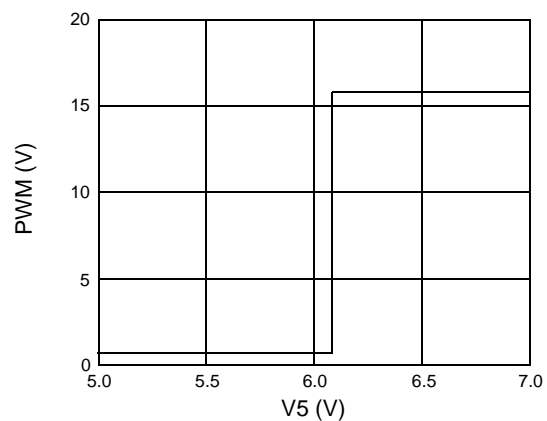

Figure 4. OCP Offset Voltage for 3.3V

Typical Characteristics (Continued)

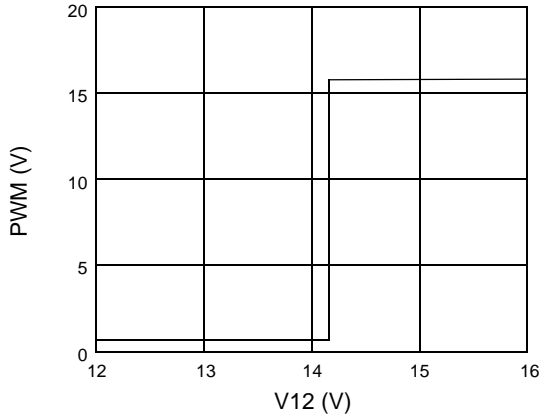

Figure 7. Over Voltage Protection for +12V

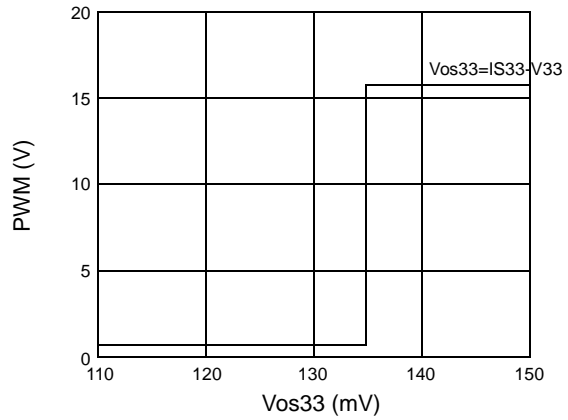

Figure 8. OCP Offset Voltage for 3.3V

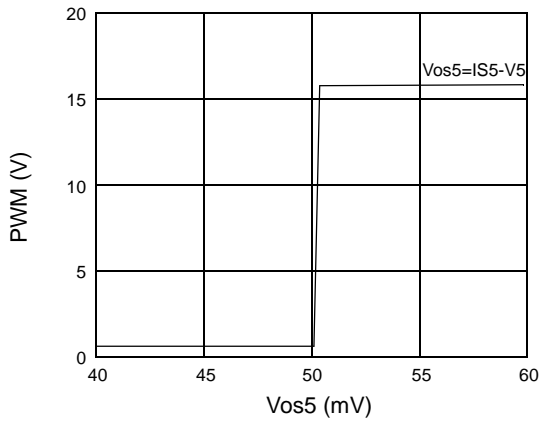

Figure 9. OCP Offset Voltage for 5V

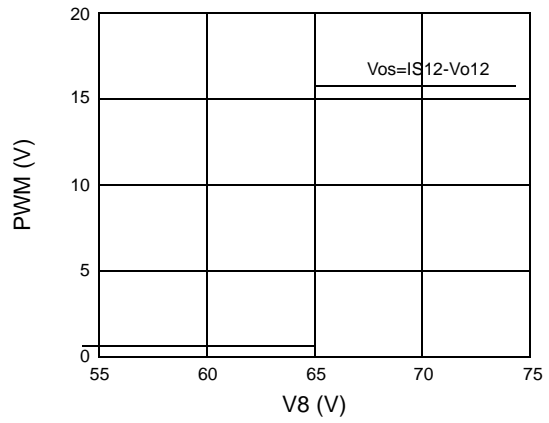

Figure 10. OCP Offset Voltage for 12V

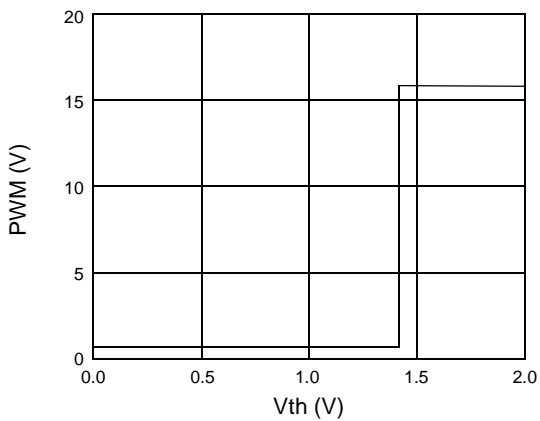

Figure 11. Remotr On/Off Input Threshold

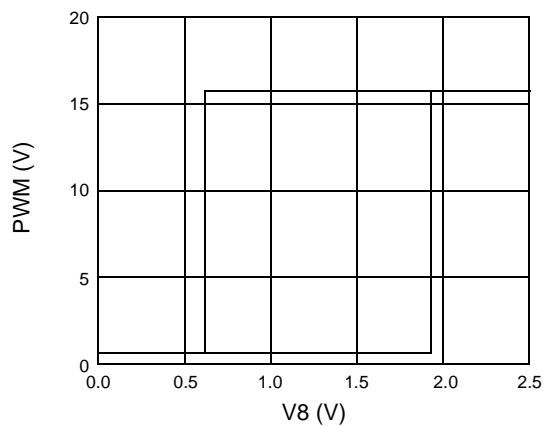

Figure 12. ON/OFF Delay Threshold Voltage

Typical Characteristics (Continued)

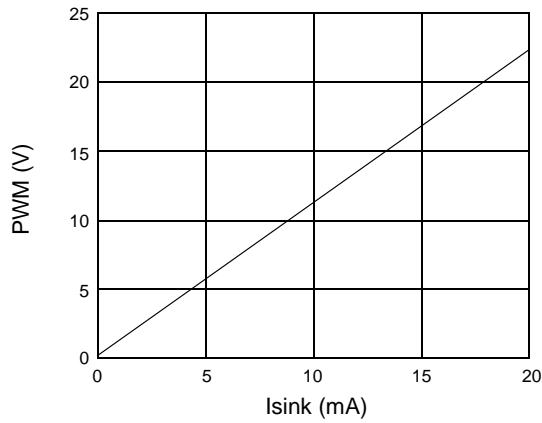

Figure 13. PWM Saturation Voltage

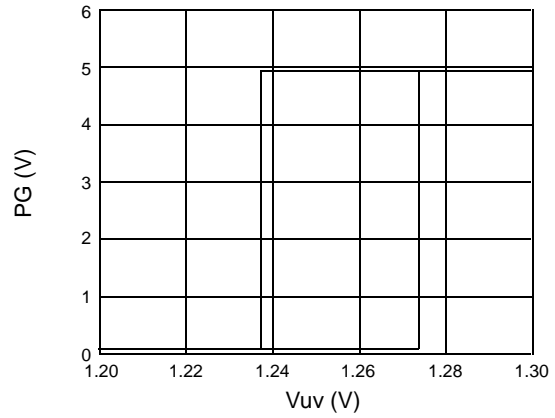

Figure 14. Detecting UV Voltage

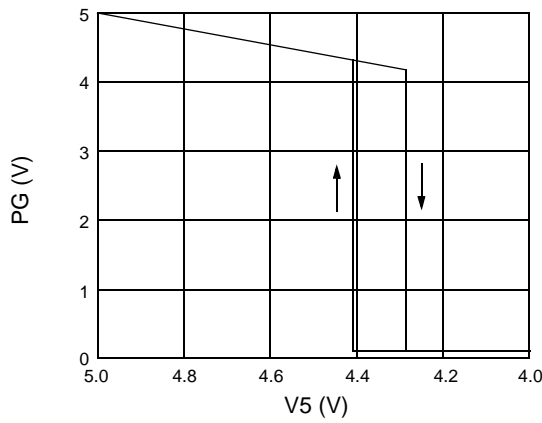

Figure 15. Detecting V5 Voltage for PG

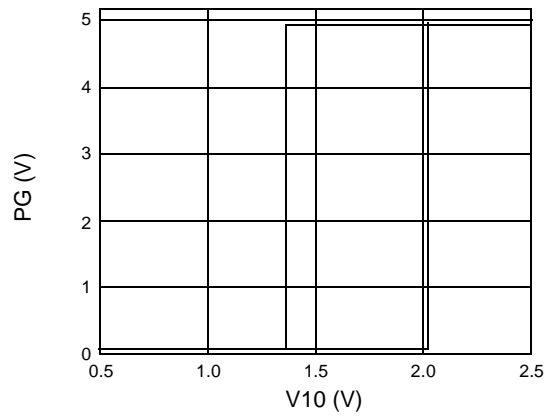

Figure 16. High/low Threshold Voltage of Comp9

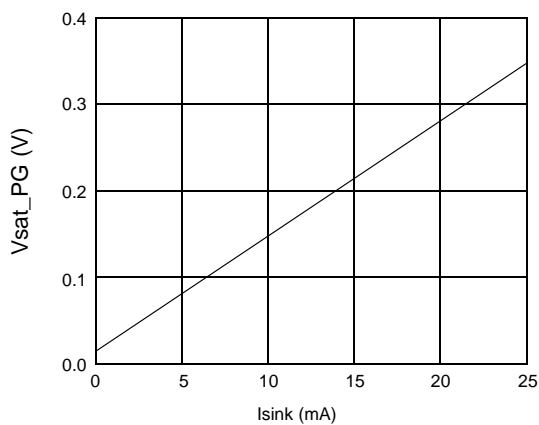

Figure 17. PG Saturating Voltage

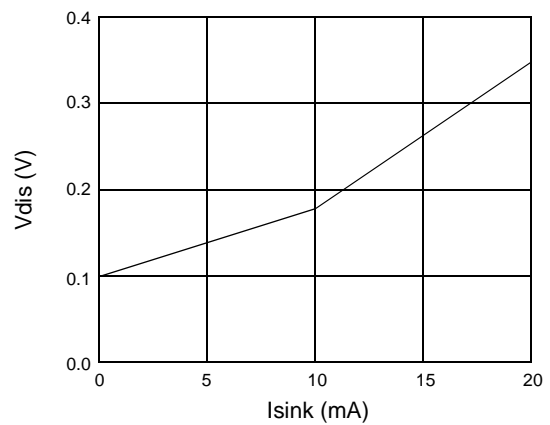

Figure 18. Disable Saturation Voltage

Typical Characteristics (Continued)

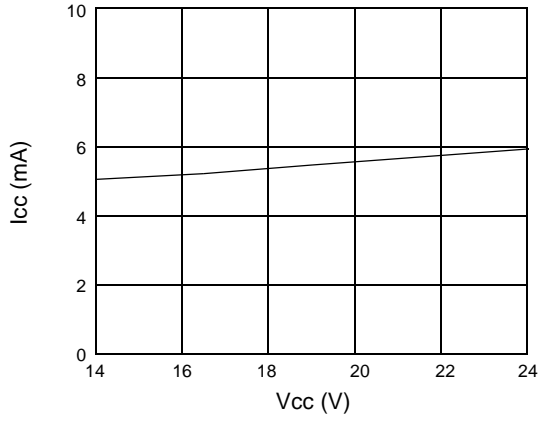

Figure 19. Supply Current of Vcc

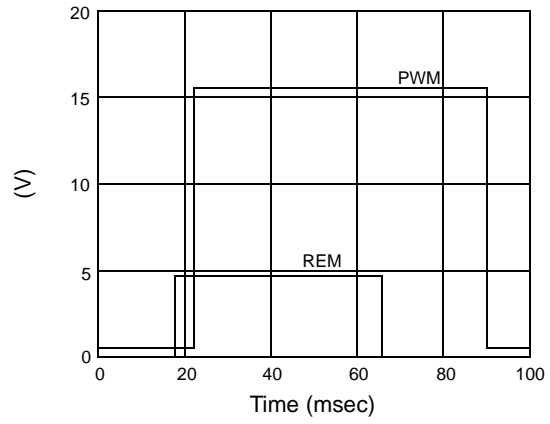

Figure 20.

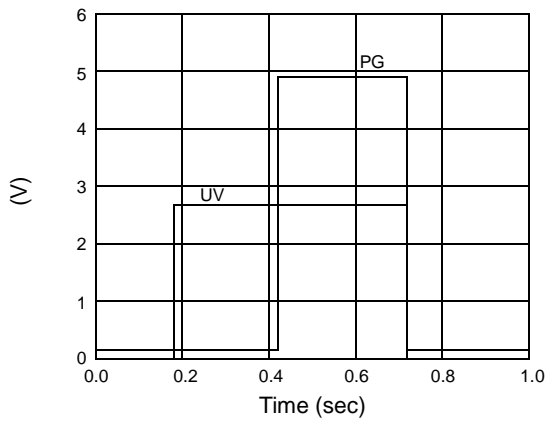

Figure 21. PG Delay

Mechanical Dimensions

Package

Dimensions in millimeters

20-DIP

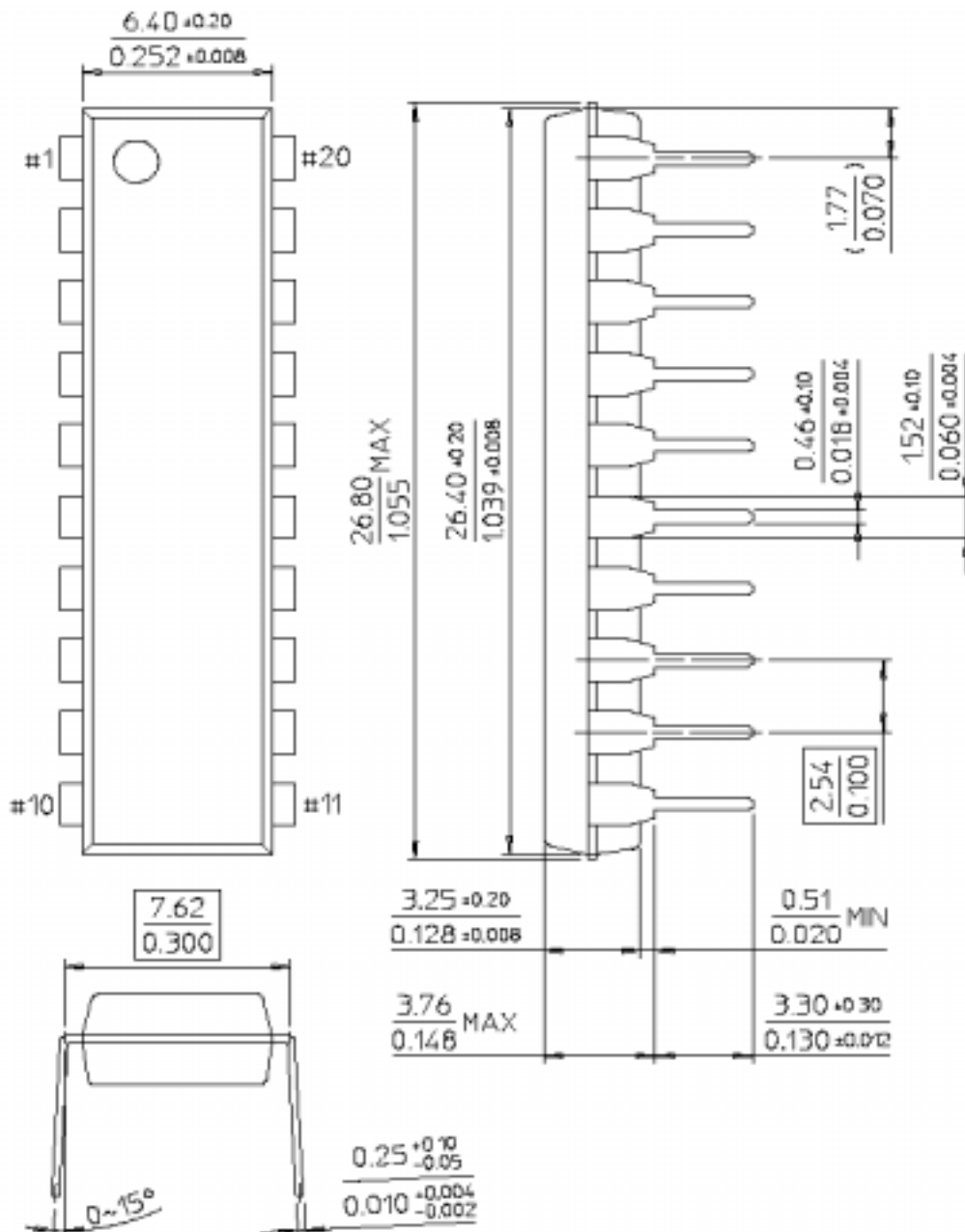

Ordering Information

Product Number	Package	Operating Temperature
KA3502	20-DIP	0°C ~ 70°C

DISCLAIMER

FAIRCHILD SEMICONDUCTOR RESERVES THE RIGHT TO MAKE CHANGES WITHOUT FURTHER NOTICE TO ANY PRODUCTS HEREIN TO IMPROVE RELIABILITY, FUNCTION OR DESIGN. FAIRCHILD DOES NOT ASSUME ANY LIABILITY ARISING OUT OF THE APPLICATION OR USE OF ANY PRODUCT OR CIRCUIT DESCRIBED HEREIN; NEITHER DOES IT CONVEY ANY LICENSE UNDER ITS PATENT RIGHTS, NOR THE RIGHTS OF OTHERS.

LIFE SUPPORT POLICY

FAIRCHILD'S PRODUCTS ARE NOT AUTHORIZED FOR USE AS CRITICAL COMPONENTS IN LIFE SUPPORT DEVICES OR SYSTEMS WITHOUT THE EXPRESS WRITTEN APPROVAL OF THE PRESIDENT OF FAIRCHILD SEMICONDUCTOR INTERNATIONAL. As used herein:

1. Life support devices or systems are devices or systems which, (a) are intended for surgical implant into the body, or (b) support or sustain life, and (c) whose failure to perform when properly used in accordance with instructions for use provided in the labeling, can be reasonably expected to result in a significant injury of the user.
2. A critical component in any component of a life support device or system whose failure to perform can be reasonably expected to cause the failure of the life support device or system, or to affect its safety or effectiveness.