2SK3001

GaAs HEMT
Low Noise Amplifier

HITACHI

ADE-208-597(Z)
1st. Edition
December 1997

Features

- Excellent low noise characteristics.
Fmin = 0.8 dB typ. (3 V, 5 mA, 0.9 GHz)
- High associated gain.
Ga = 18 dB typ. (3 V, 5 mA, 0.9 GHz)
- Small package. (CMPAK-4)

Outline

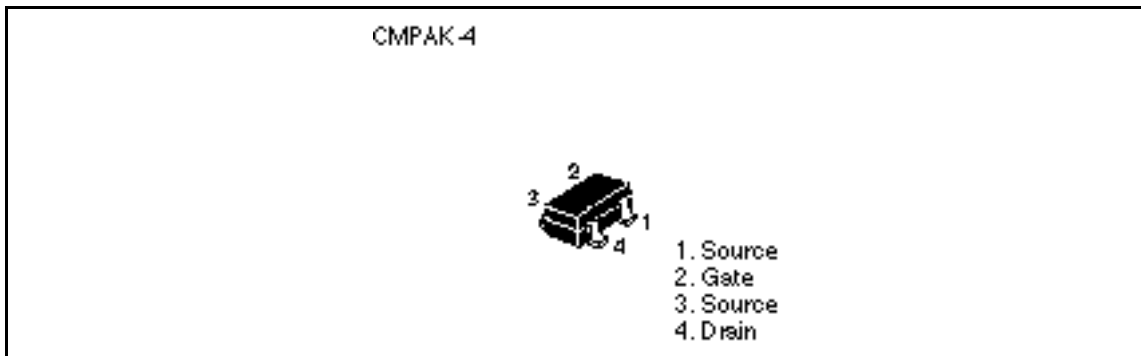

This document may, wholly or partially, be subject to change without notice.

This Device is sensitive to Electro Static Discharge.
It is recommended to adopt appropriate cautions when handling this transistor.

CAUTION

This product use GaAs. Since dust or fume of GaAs is highly poisonous to human body, please do not treat them mechanically in the manner which might expose to the Air. And it should never be thrown out with general industrial or domestic wastes.

2SK3001

Absolute Maximum Ratings (Ta = 25°C)

Item	Symbol	Ratings	Unit
Drain to source voltage	V _{DSS}	6	V
Gate to source voltage	V _{GSO}	-4	V
Gate to drain voltage	V _{GDO}	-4	V
Drain current	I _D	20	mA
Channel dissipation	P _{ch}	100	mW
Channel temperature	T _{ch}	125	°C
Storage temperature	T _{stg}	-55 to +125	°C

Electrical Characteristics (Ta = 25°C)

Item	Symbol	Min	Typ	Max	Unit	Test Conditions
Gate to source leak current	I _{GSS}	—	—	-20	μA	V _{GS} = -4 V, V _{DS} = 0
Gate to source cutoff voltage	V _{GS(off)}	-0.5	—	-1.5	V	V _{DS} = 3 V, I _D = 100 μA
Drain to source current	I _{DSS}	35	50	70	mA	V _{DS} = 3 V, V _{GS} = 0 Pulse test
Forward transfer admittance	y _{fs}	40	60	—	mS	V _{DS} = 3 V, I _D = 10 mA f = 1 kHz
Power Gain	PG	15.0	18.0	—	dB	V _{DS} = 3 V, I _D = 5 mA f = 0.9 GHz
Noise Figure	NF	—	0.8	1.2	dB	
Associated gain	Ga	—	21.0	—	dB	V _{DS} = 3 V, I _D = 5 mA f = 0.8 GHz, Z _s = Z _{sopt}
Minimum noise figure	F _{min}	—	0.7	—	dB	
Associated gain	Ga	—	16.0	—	dB	V _{DS} = 3 V, I _D = 5 mA f = 1.8 GHz, Z _s = Z _{sopt}
Minimum noise figure	F _{min}	—	0.75	—	dB	

Note: Marking of 2SK3001 is "YX—"

Main Characteristics

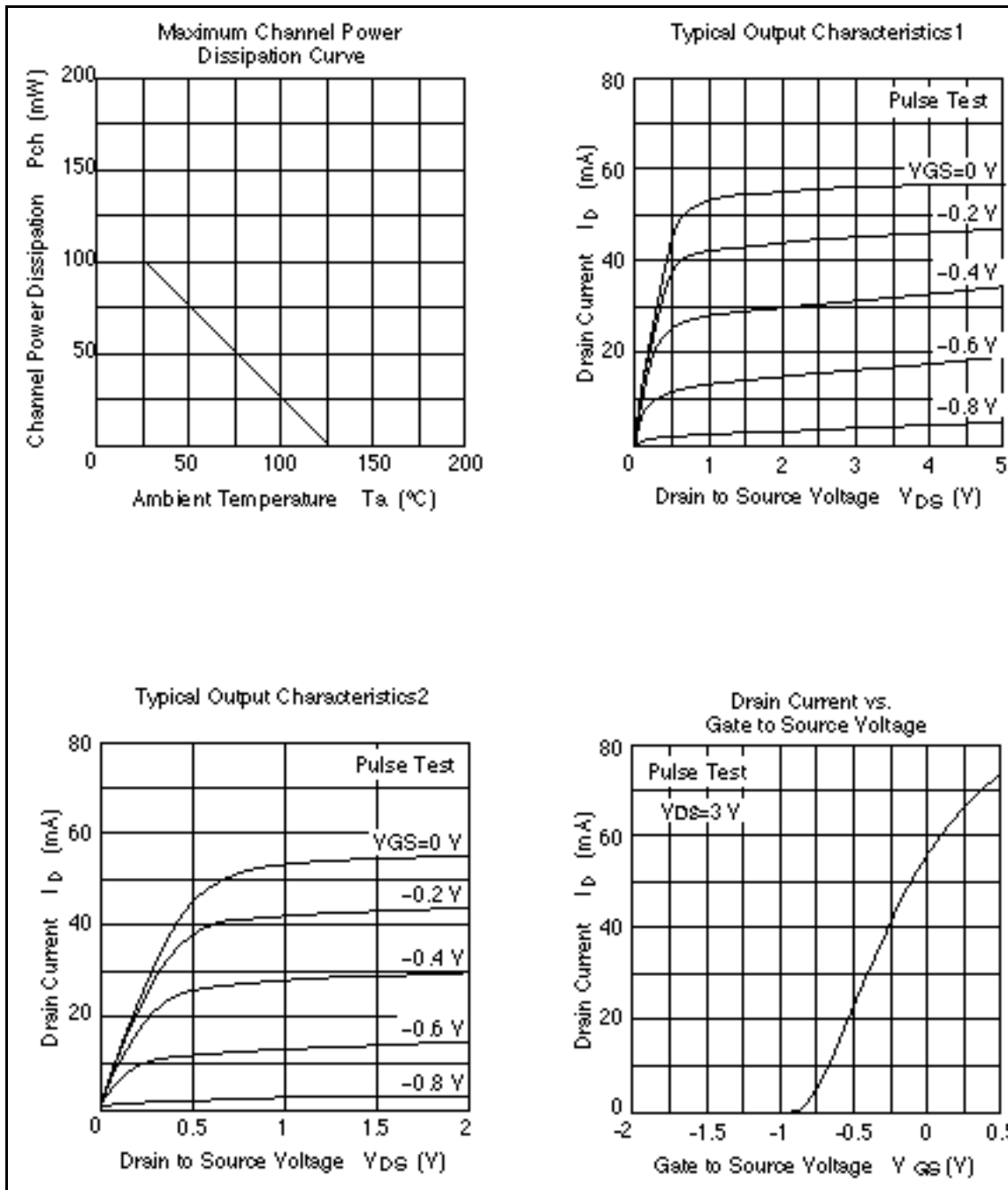

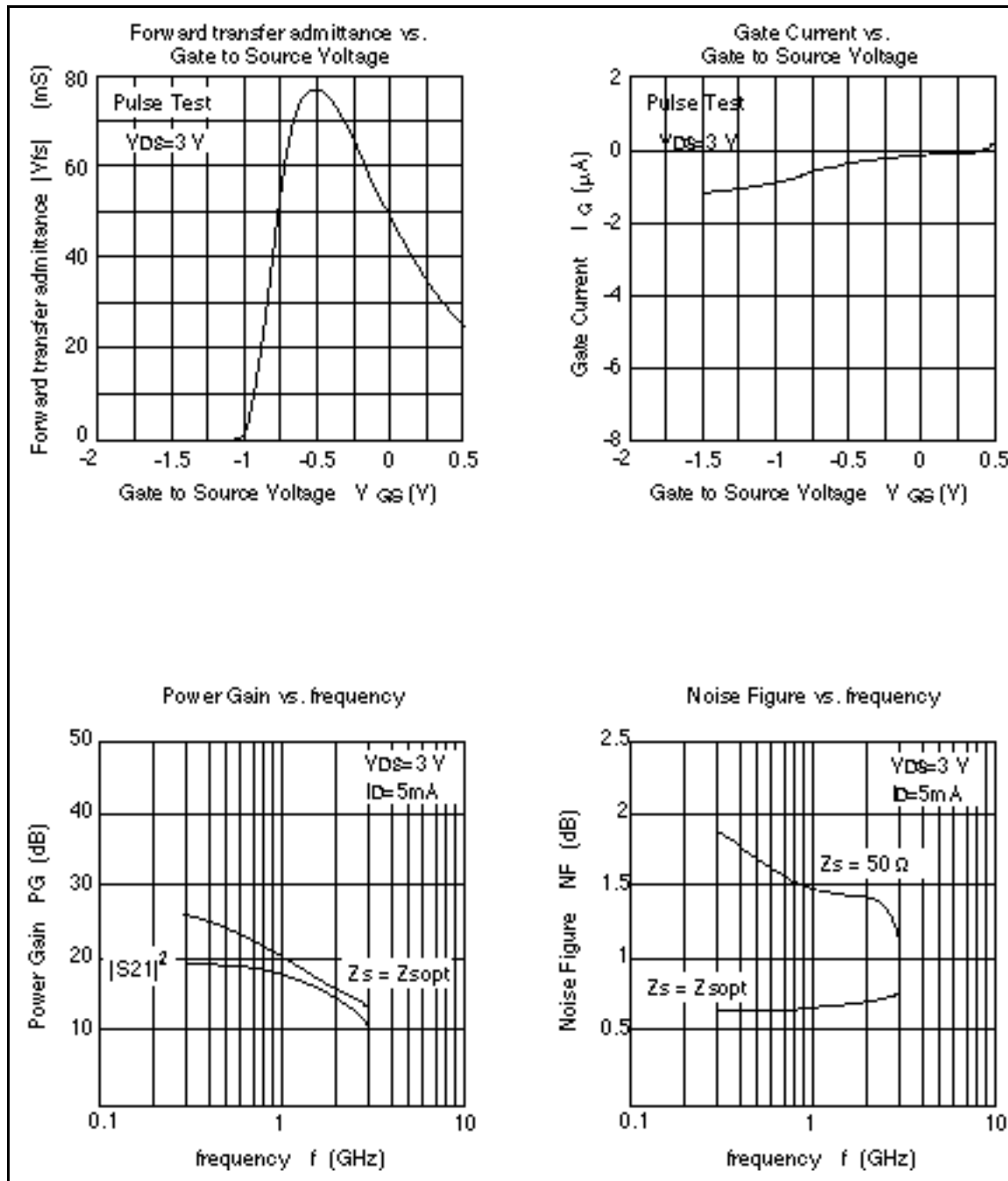

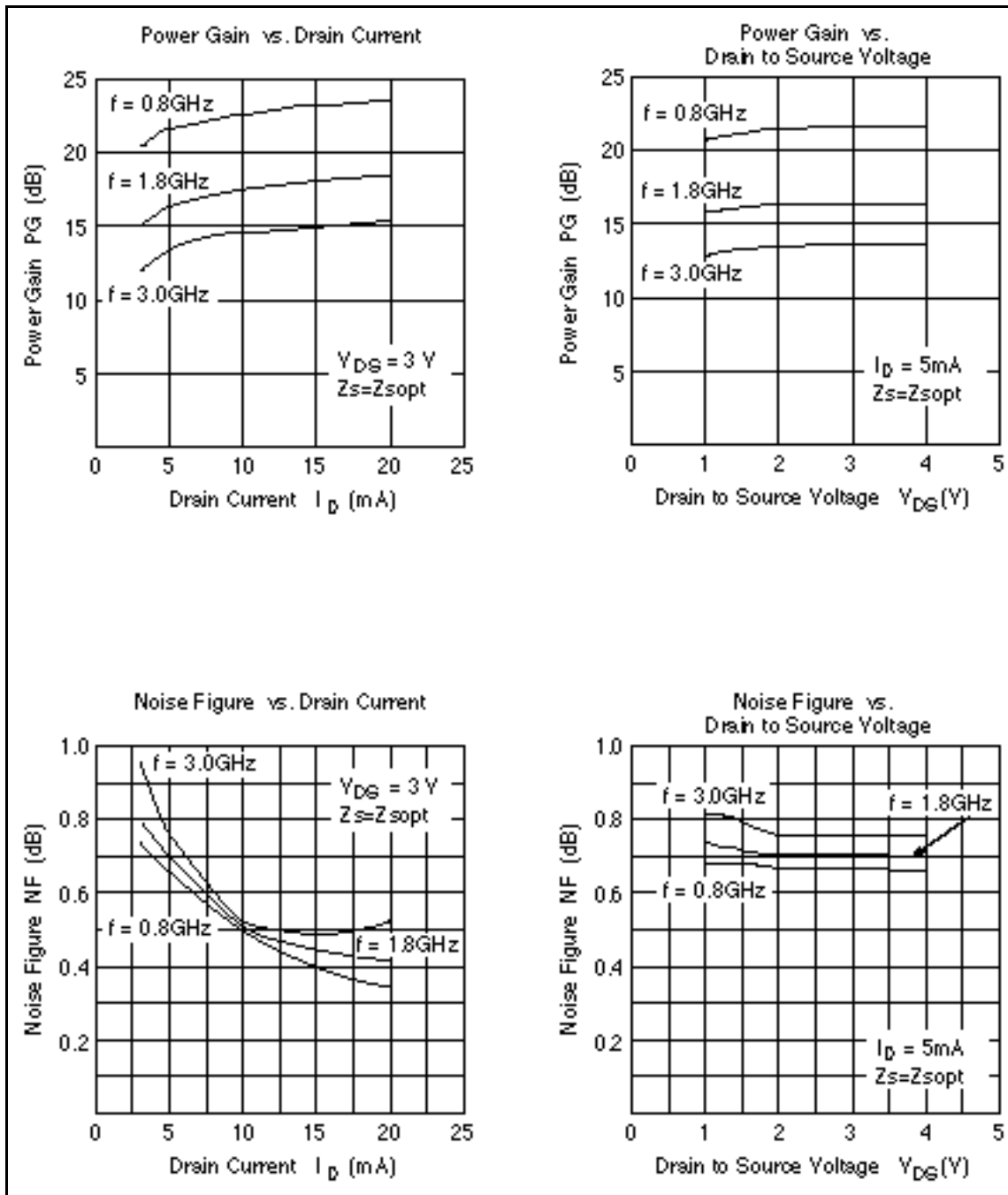

2SK3001

Sparameter (Smith Plot $Z_0=50\Omega$)

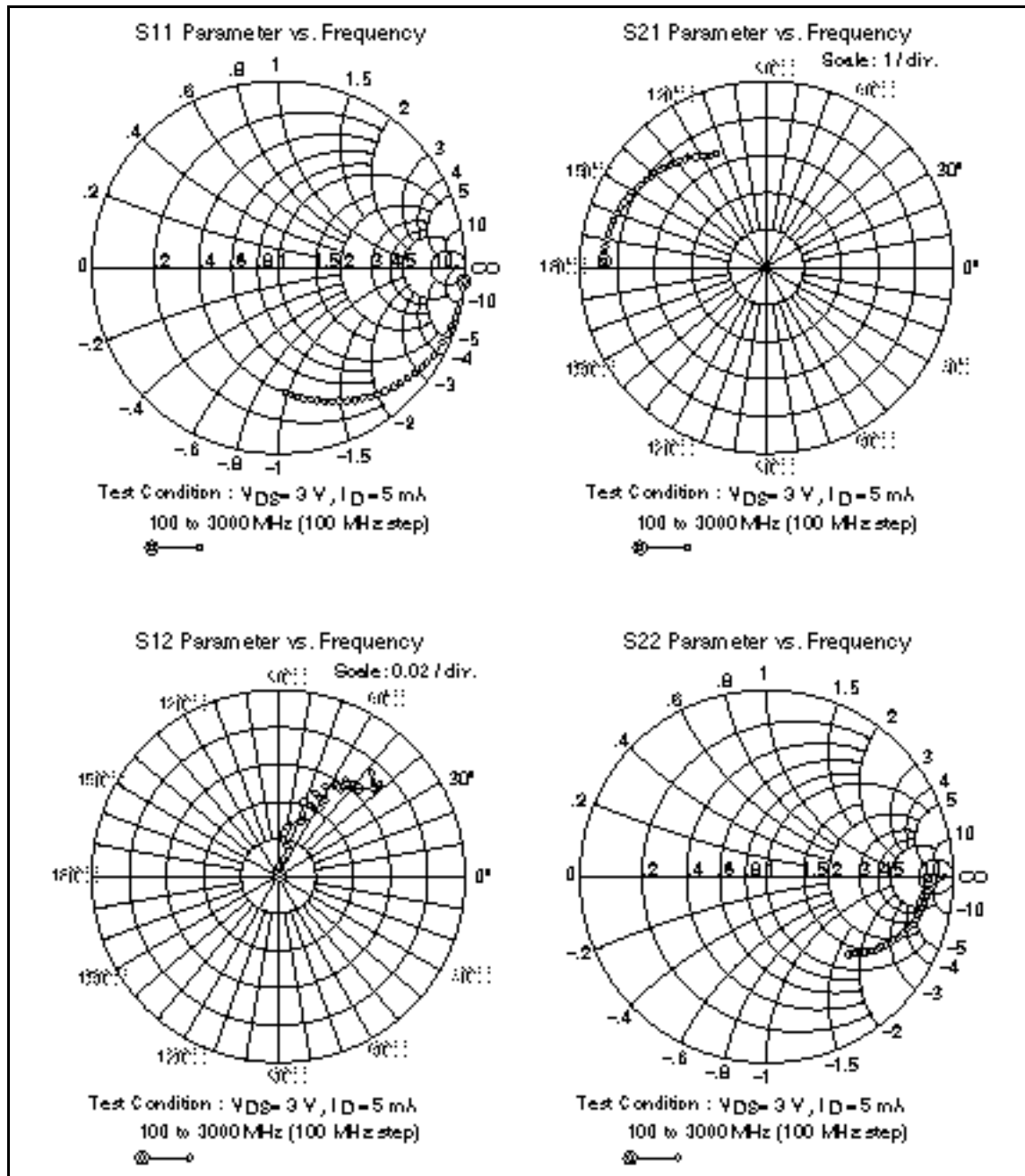

Sparameter ($V_{DS} = 3 \text{ V}$, $I_D = 5 \text{ mA}$, $Z_0 = 50 \text{ } \Omega$)

Freq (GHz)	S11 (Mag)	S11 (Ang)	S21 (Mag)	S21 (Ang)	S12 (Mag)	S12 (Ang)	S22 (Mag)	S22 (Ang)
0.1	0.998	-4.1	4.4	177.6	0.001	49.2	0.875	-1.2
0.2	0.995	-6.5	4.4	175.1	0.005	86.3	0.869	-3.1
0.3	0.993	-10.9	4.4	172.6	0.010	75.2	0.869	-5.1
0.4	0.990	-13.4	4.3	170.2	0.017	73.6	0.863	-6.7
0.5	0.989	-14.5	4.3	169.1	0.015	82.9	0.865	-7.1
0.6	0.981	-17.0	4.3	166.3	0.020	81.6	0.859	-9.0
0.7	0.976	-20.0	4.3	163.9	0.026	73.7	0.856	-10.6
0.8	0.965	-23.5	4.3	161.4	0.025	74.3	0.851	-12.1
0.9	0.956	-28.2	4.2	159.0	0.032	76.5	0.834	-14.0
1.0	0.949	-31.1	4.2	156.4	0.029	75.2	0.837	-15.4
1.1	0.942	-33.9	4.2	154.3	0.036	65.0	0.830	-16.8
1.2	0.930	-36.3	4.1	152.0	0.039	67.0	0.819	-18.4
1.3	0.918	-39.5	4.1	149.6	0.037	65.4	0.810	-20.1
1.4	0.903	-42.2	4.0	147.4	0.042	61.2	0.800	-21.8
1.5	0.895	-44.8	4.0	145.1	0.045	65.9	0.789	-23.1
1.6	0.882	-47.8	3.9	143.1	0.046	60.5	0.779	-24.4
1.7	0.869	-50.9	4.0	140.7	0.053	61.8	0.768	-26.0
1.8	0.856	-53.3	3.9	138.3	0.056	57.4	0.753	-27.2
1.9	0.843	-55.6	3.8	136.7	0.055	56.8	0.747	-28.7
2.0	0.826	-59.0	3.9	133.9	0.059	53.8	0.736	-30.4
2.1	0.814	-61.8	3.8	132.3	0.059	52.9	0.720	-31.5
2.2	0.800	-64.0	3.7	130.0	0.062	48.2	0.710	-32.6
2.3	0.785	-67.0	3.7	128.1	0.059	51.5	0.700	-34.4
2.4	0.767	-69.8	3.6	126.8	0.063	48.5	0.692	-35.4
2.5	0.751	-72.4	3.6	123.5	0.065	47.6	0.676	-36.7
2.6	0.742	-75.0	3.5	123.3	0.065	47.4	0.661	-37.9
2.7	0.719	-78.3	3.5	120.0	0.063	48.7	0.652	-39.2
2.8	0.710	-80.3	3.4	118.9	0.074	46.7	0.645	-40.0
2.9	0.689	-82.8	3.3	116.9	0.070	41.0	0.630	-41.4
3.0	0.675	-85.6	3.4	116.0	0.074	41.8	0.618	-43.7

2SK3001

optimize ($V_{DS} = 3\text{ V}$, $I_D = 5\text{ mA}$)

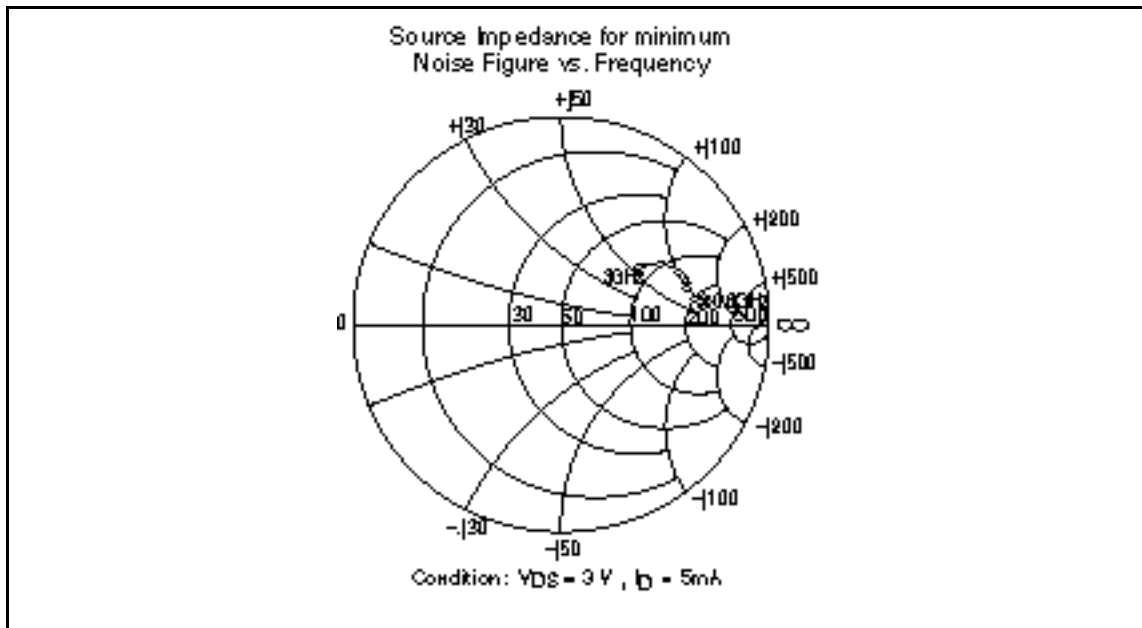

Noise parameter ($V_{DS} = 3\text{ V}$, $I_D = 5\text{ mA}$)

Freq (GHz)	Fmin ¹ (dB)	Ga (dB)	Gopt (Mag)	Gopt (Ang)	RN ()	NF 50 ² (dB)	S21 ² (dB)	S21 ² -
0.8	0.67	21.7	0.69	8.8	19.1	1.53	18.2	4.26
0.9	0.67	21.0	0.68	9.8	18.7	1.50	18.0	4.24
1.0	0.67	20.3	0.66	10.7	18.4	1.48	17.5	4.19
1.5	0.69	17.6	0.64	15.7	17.5	1.44	16.0	3.99
1.7	0.70	16.8	0.64	17.8	17.4	1.44	15.3	3.92
1.8	0.71	16.4	0.64	18.9	17.3	1.44	15.0	3.88
1.9	0.71	16.1	0.64	20.1	17.1	1.44	14.8	3.85
2.0	0.72	15.8	0.64	21.3	17.0	1.44	14.2	3.76
2.2	0.72	15.2	0.63	23.8	16.6	1.43	13.6	3.69
2.5	0.74	14.6	0.60	28.1	15.6	1.37	12.3	3.50
2.7	0.74	14.2	0.56	31.3	14.6	1.30	11.9	3.44
3.0	0.76	13.6	0.47	36.7	12.6	1.15	11.1	3.33

note 1. Input matched for minimum noise figure, Output for maximum gain.

2. $Z_s = Z_L = 50$

Test Fixture ($f = 0.9 \text{ GHz}$)

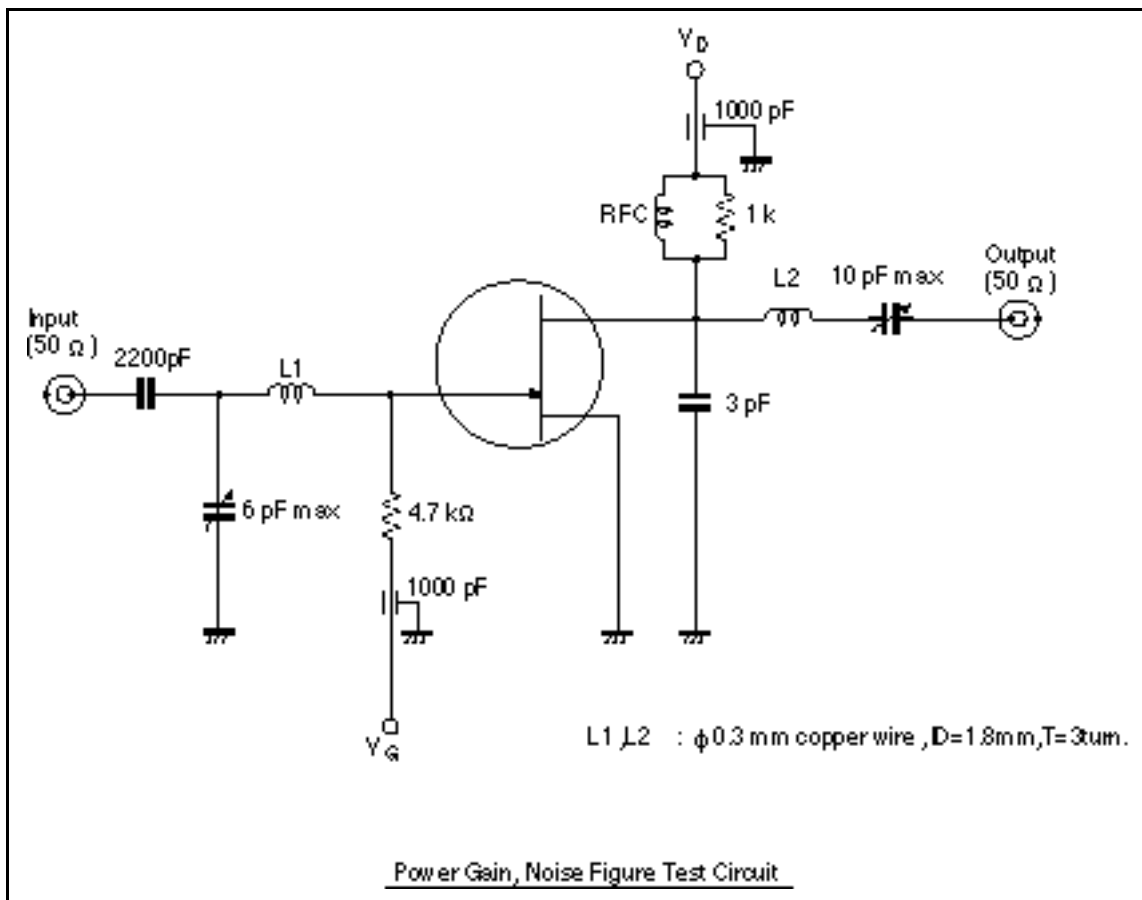

Characteristics (Test Fixture)

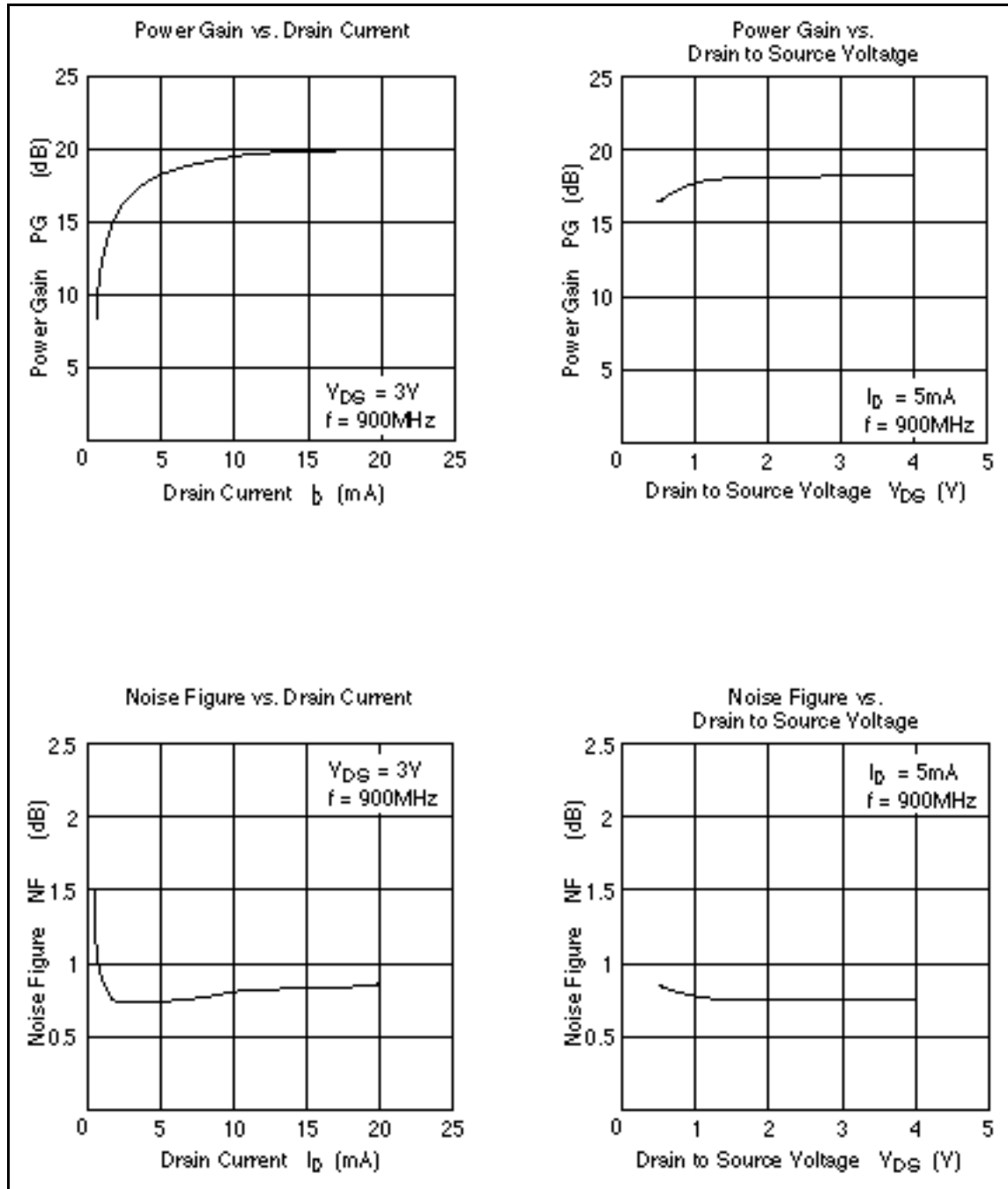

Application (f = 1.8 GHz LNA)

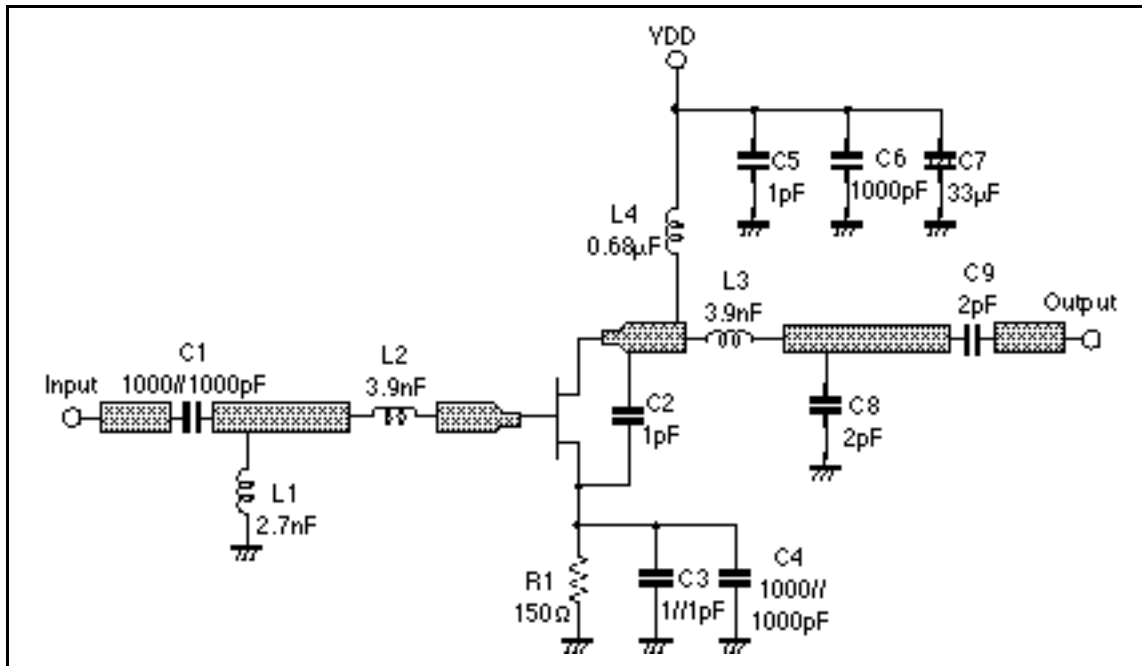

PCB Pattern & Parts Layouts

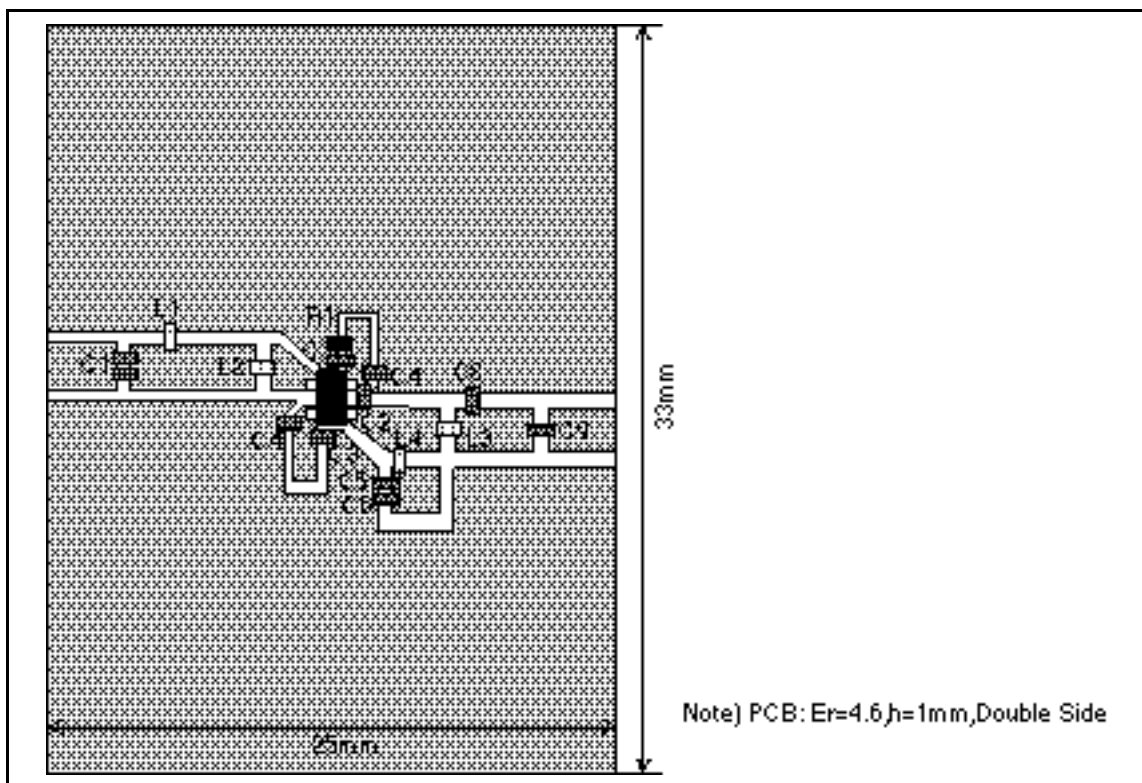

Characteristics

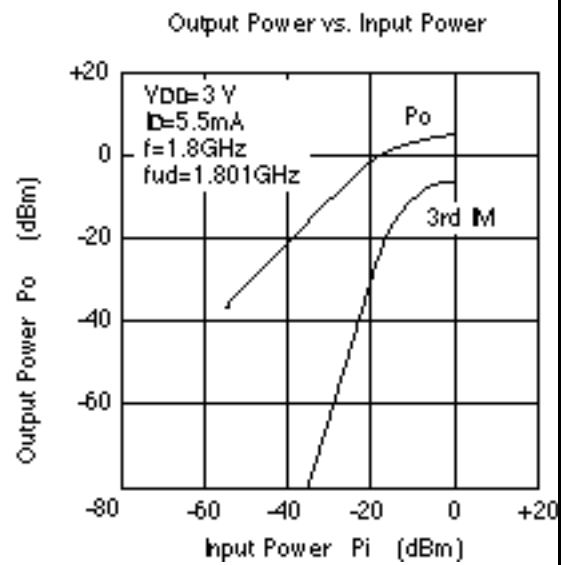
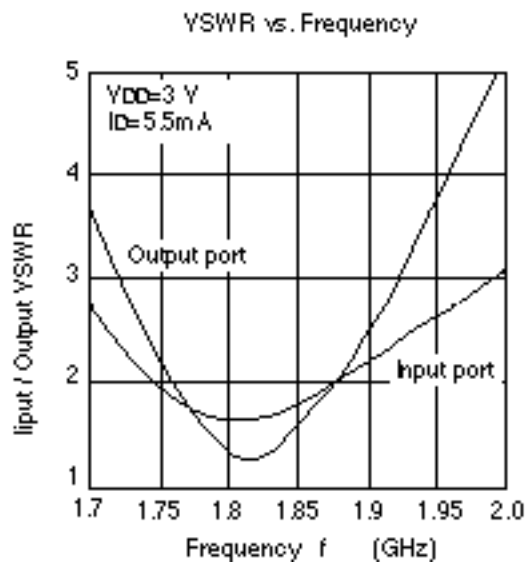
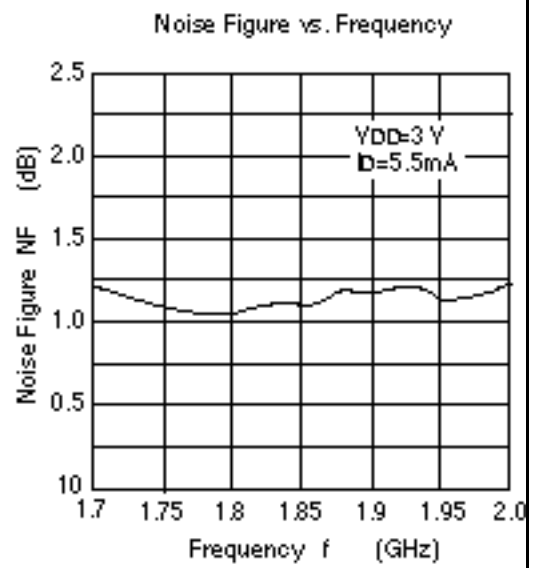
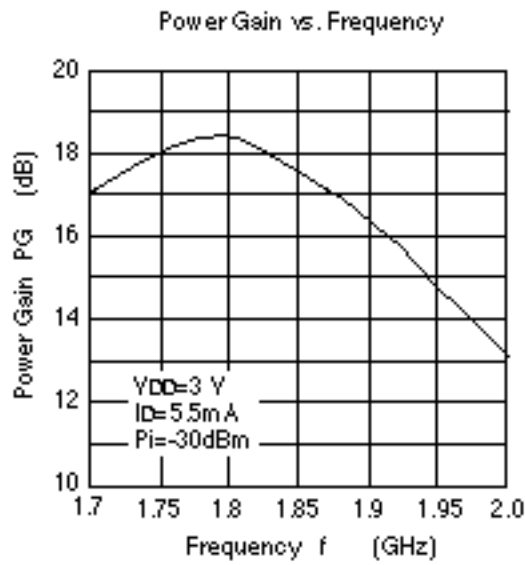

Package Dimensions

Unit: mm

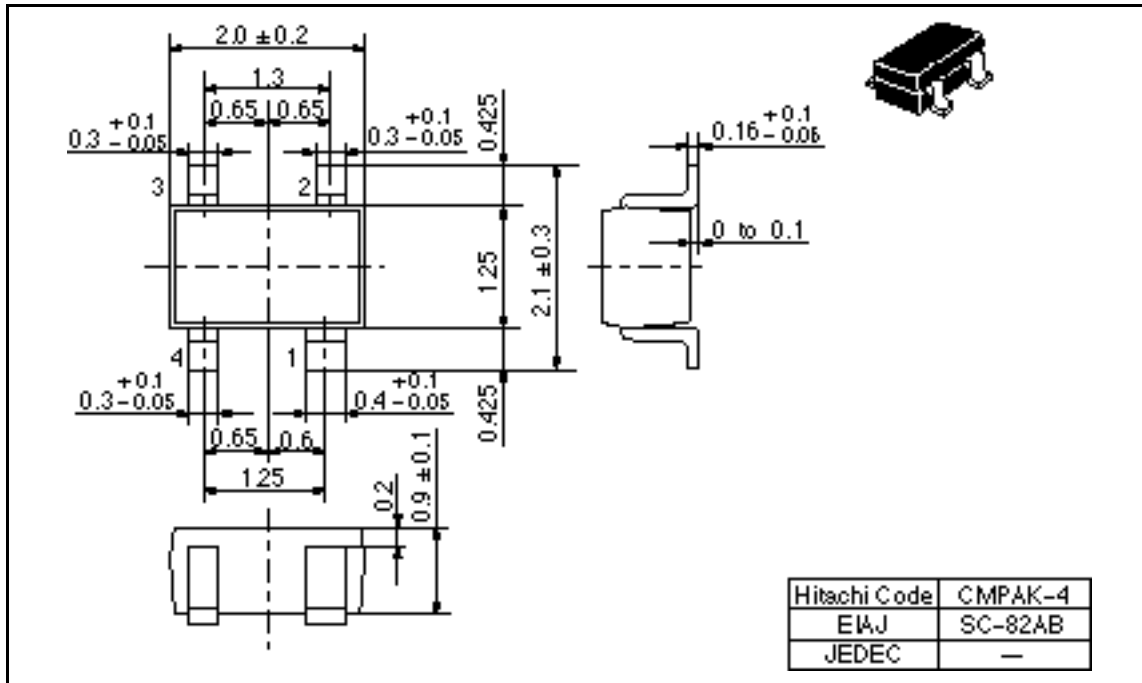

When using this document, keep the following in mind:

1. This document may, wholly or partially, be subject to change without notice.
2. All rights are reserved: No one is permitted to reproduce or duplicate, in any form, the whole or part of this document without Hitachi's permission.
3. Hitachi will not be held responsible for any damage to the user that may result from accidents or any other reasons during operation of the user's unit according to this document.
4. Circuitry and other examples described herein are meant merely to indicate the characteristics and performance of Hitachi's semiconductor products. Hitachi assumes no responsibility for any intellectual property claims or other problems that may result from applications based on the examples described herein.
5. No license is granted by implication or otherwise under any patents or other rights of any third party or Hitachi, Ltd.
6. **MEDICAL APPLICATIONS:** Hitachi's products are not authorized for use in **MEDICAL APPLICATIONS** without the written consent of the appropriate officer of Hitachi's sales company. Such use includes, but is not limited to, use in life support systems. Buyers of Hitachi's products are requested to notify the relevant Hitachi sales offices when planning to use the products in **MEDICAL APPLICATIONS**.

HITACHI

Hitachi, Ltd.

Semiconductor & IC Div.

Nippon Bldg., 2-6-2, Chita-machi, Chiyoda-ku, Tokyo 100, Japan

Tel: Tokyo (03) 3270-2111

Fax: (03) 3270-5109

For further information write to:

Hitachi Semiconductor
(America) Inc

2000 Sierra Point Parkway

Brisbane, CA 94005-4897

U.S.A.

Tel: 800-285-1601

Fax: 303-297-0447

Hitachi Europe GmbH

Continental Europe

Dornacher Straße 3

D-85622 Feldkirchen

München

Tel: 089-9 24 80-0

Fax: 089-9 29 30-00

Hitachi Europe Ltd.

Electronic Components Div.

Northern Europe Headquarters

Whitbrook Park

Lower Cookham Road

M Maidenhead

Berkshire SL6 8YA

United Kingdom

Tel: 01628-585000

Fax: 01628-585160

Hitachi Asia Pte. Ltd.

45 Collyer Quay #20-00

Hitachi Tower

Singapore 049318

Tel: 535-2100

Fax: 535-1533

Hitachi Asia (Hong Kong) Ltd.

Unit 705, North Tower,

World Finance Centre

Harbour City, Canton Road

Tsim Sha Tsui, Kowloon

Hong Kong

Tel: 27389218

Fax: 27388711

Copyright ©Hitachi, Ltd., 1997. All rights reserved. Printed in Japan.