

TA7089PBIPOLAR LINEAR INTEGRATED CIRCUIT
SILICON MONOLITHIC

GENERAL PURPOSE VOLTAGE REGULATOR.

- Low Output Impedance : $Z_o = 40m\Omega$ (Typ.)
- High Ripple Rejection : $RR=48dB$ (Typ.)
- Built in Current Limiting Circuit
- Low Drop Out Voltage : $|V_{IN}-V_{OUT}|=1.8V$
- High Output Current : $I_{OUT}=200mA$ (Max.)
- Output Current Up to 5A Can be Supplied by Connecting External Transistor.
- The TA7089P is Easily Mounted on a Printed Circuit Board, and is Provided with 14 Pin Output, 7 Pin GND and 1 Pin Input for Application as a Power Supply for Digital IC.

Unit in mm

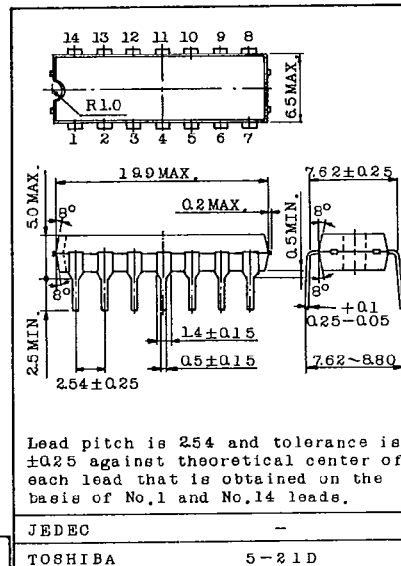

MAXIMUM RATINGS

CHARACTERISTIC	SYMBOL	RATING	UNIT
Input Voltage	V_{IN}	35	V
Terminal Voltage 8	V_8	7	V
Output Current	I_{OUT}	-200	mA
Power Dissipation	P_D	600	mW
Operating Temperature	T_{opr}	-30 ~ 75	$^{\circ}C$
Storage Temperature	T_{stg}	-55 ~ 125	$^{\circ}C$

PIN CONNECTION

TOP VIEW

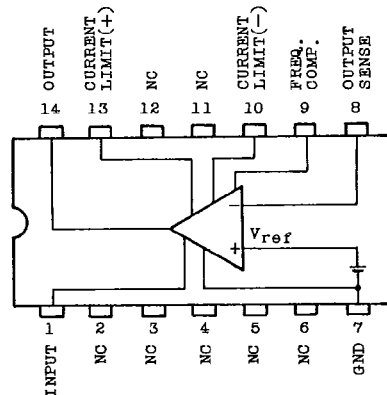

ELECTRICAL CHARACTERISTICS (Ta=25°C)

CHARACTERISTIC	SYMBOL	TEST CIR-CUIT	TEST CONDITION	MIN.	TYP.	MAX.	UNIT
Input Voltage	V _{IN}	1	-	7	-	35	V
Output Voltage	V _{OUT}	1	7 < V _{IN} < 35V I _{OUT} =50mA	3.3	0	33	V
Drop Output Voltage	V _{IN} -V _{OUT}	1	R _{SC} =0, I _{OUT} =200mA	2.0	1.8	-	V
Reference, Voltage	V _{ref}	1	7 < V _{IN} < 35V I _{OUT} =0mA	2.7	3.0	3.3	V
Bias Current	I _B	1	7 < V _{IN} < 35V V _{OUT} =0mA	1.5	3	6	mA
Ripple Rejection	RR	2	V _{IN} =14V, f=1kHz V _{OUT} =10V, I _{OUT} =50mA	40	48	-	dB
Output Voltage Temperature Coefficient	TC _{VO}	1	-	-	±0.02	-	%/°C
Output Current	I _{OUT}	1	-	-	-	-200	mA
Output Impedance	Z _o	3	V _{IN} =14V, f=1kHz V _{OUT} =10V, I _{OUT} =50mA	-	40	150	mΩ
Input Regulation	Reg·line	1	I _{OUT} =50mA 15 < V _{IN} < 35V	-	-	300	mV
Load Regulation	Reg·load	1	V _{IN} =15V 50 < I _{OUT} < 200mA	-	-	60	mV

T-5811-23

TA7089P

EQUIVALENT CIRCUIT

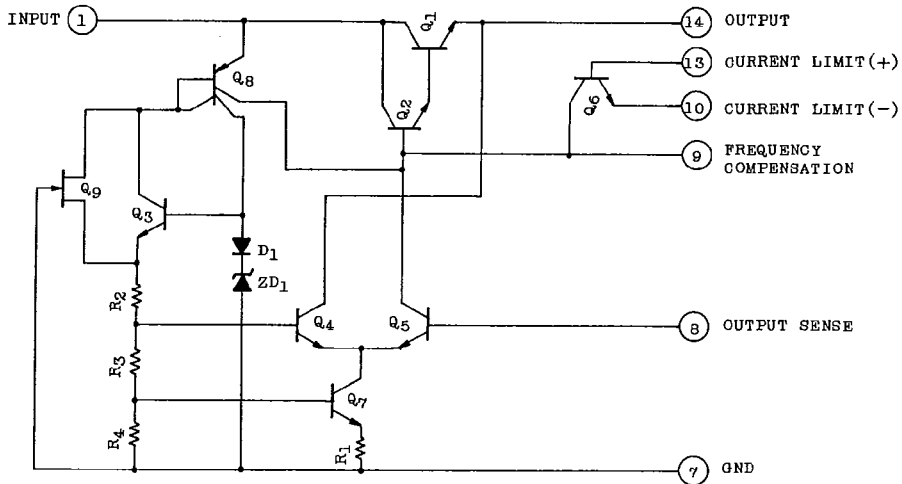

STANDARD APPLICATION CIRCUIT (10V, -100mA)

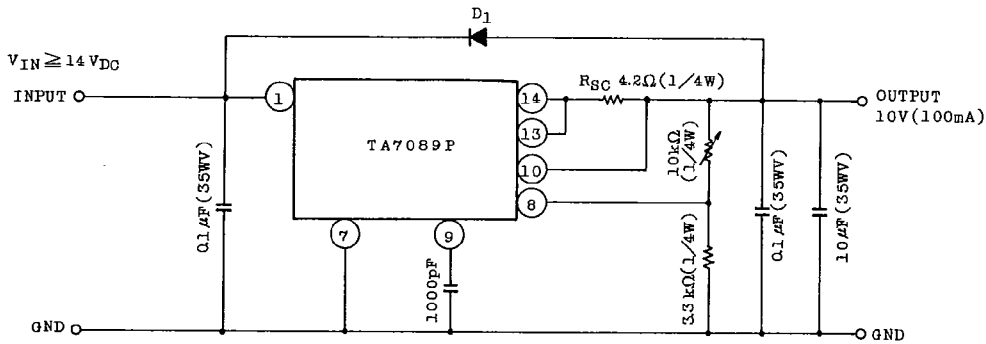

Note : IC Protecting Diode

When the surge voltage is applied to the IC output or when V_{IN}^+ becomes more than $V_{OUT}^+(C_{IN} V_{OUT})$ at times of power ON or OFF. It is required to cannot high speed diodes between input and output terminals.

T-58-11-23

STANDARD PRINT BOARD

PATTERN

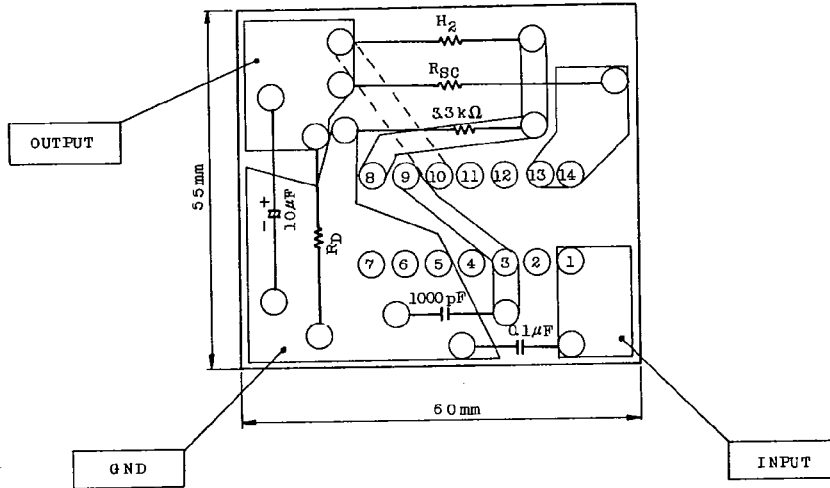

TEST CIRCUIT

1. V_{IN} , V_{OUT} , $|V_{IN}-V_{OUT}|$, I_{OUT} , I_B , V_{ref} , Reg·line, Reg·load, TC_{VO}

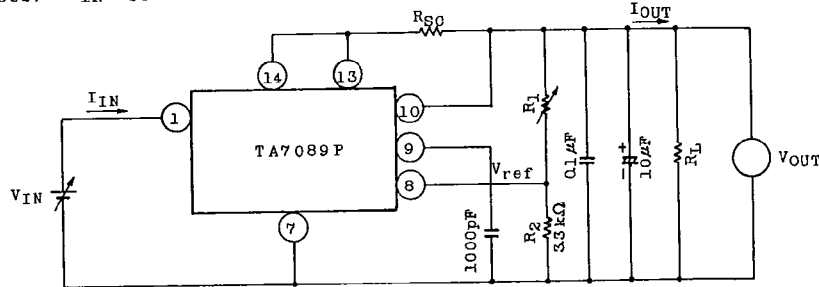

$$V_{OUT} = \frac{R_1 + R_2}{R_2} \times V_{ref}$$

$$I_B = I_{IN} - I_{OUT}$$

$$TC_{VO} = \frac{V_{OUT}(75^\circ C) - V_{OUT}(-30^\circ C)}{V_{OUT}(25^\circ C) \times 105} \times 100 \text{ (\%/}^\circ C)$$

TA7089P

T-58-11-23

2. RR

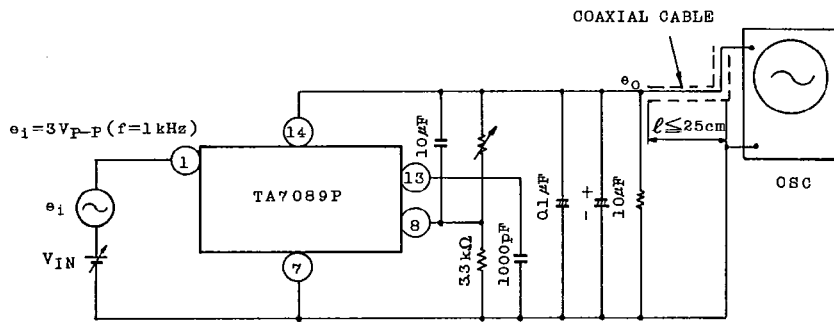

Ripple Rejection

$$RR = 20 \log_{10} \left(\frac{e_i}{e_o} \right) \text{ (dB)}$$

3. Zo

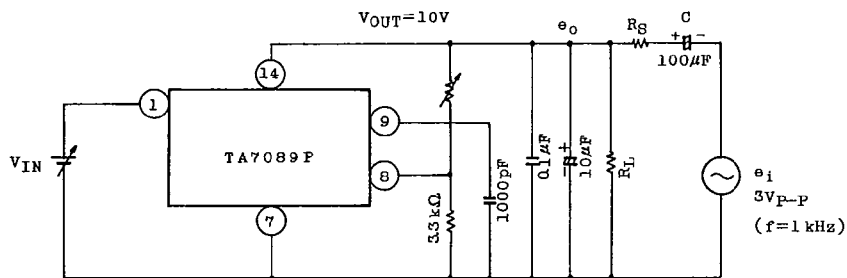

Zo Calculation Method

$$e_o = \frac{e_i}{R_S + Z_o} \cdot Z_o$$

$$R_S \gg Z_o$$

$$e_o = \frac{e_i}{R_S} \cdot Z_o$$

Therefore, $Z_o = \frac{e_o}{e_i} \cdot R_S \text{ (}\Omega\text{)}$

T-58-11-23

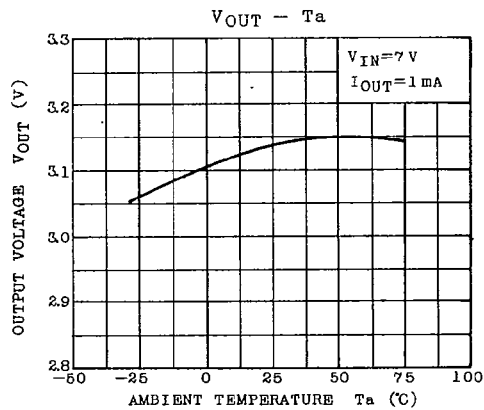
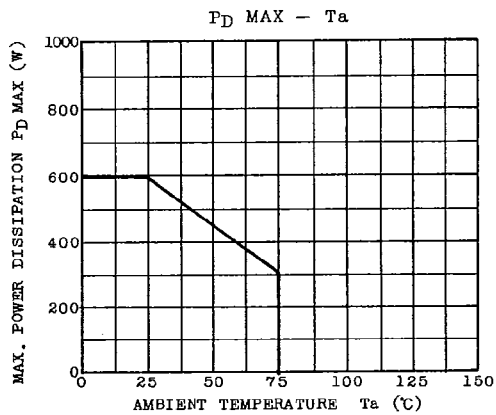
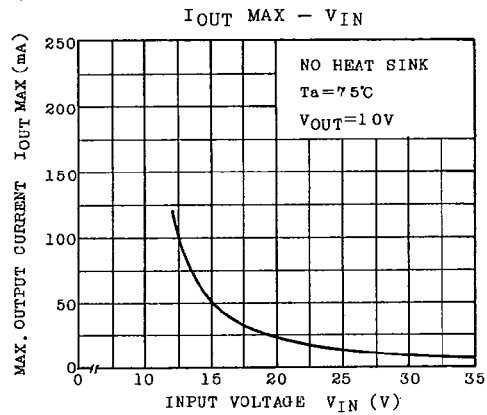
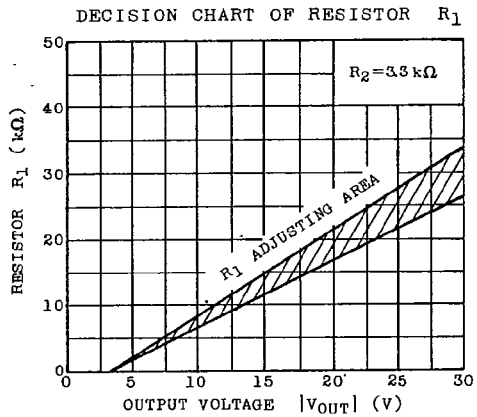

T-58-11-23

TA7089P

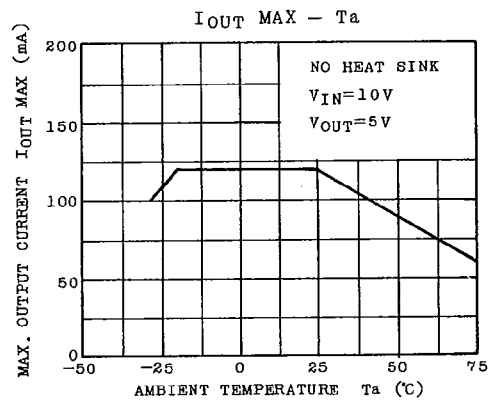
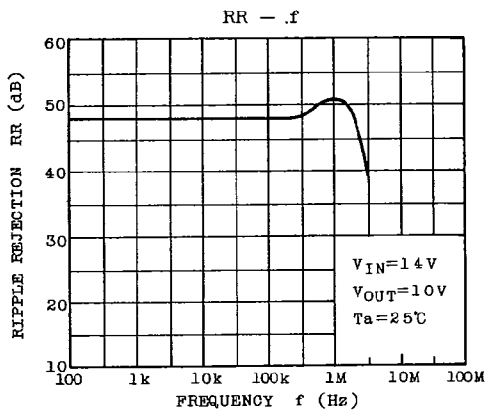
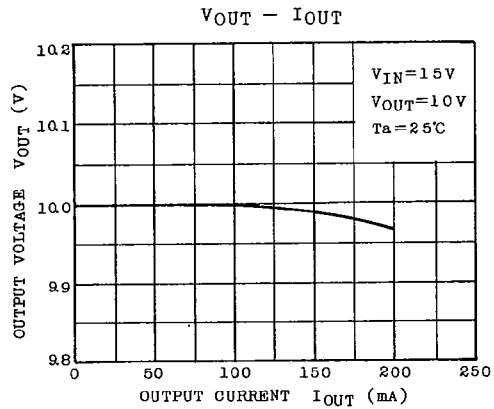
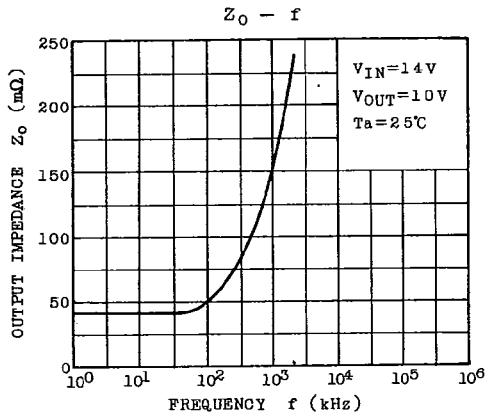

FS8-11-23

TA7089P

BLOCK DIAGRAM

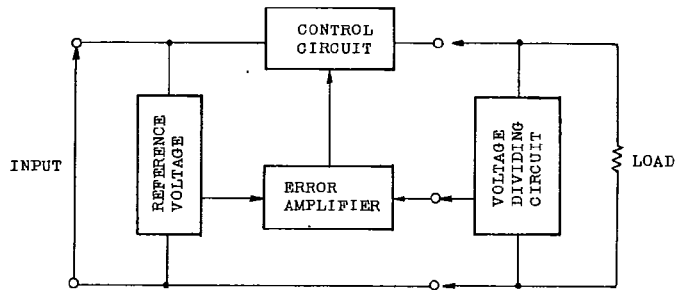

METHOD OF USE AND GENERAL PRECAUTIONS

1. Input Voltage Range

The TA7089P can be used at 7 ~ 35V.

2. Output Voltage Setting

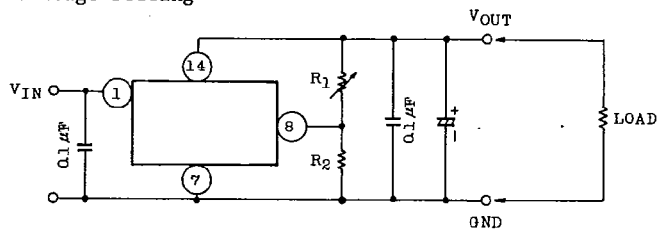

Output voltage is set by resistor R1 (See resistor-output voltage characteristic diagram.)

$$\text{If } V_{\text{OUT}} = \frac{V_{\text{ref}} (R_1 + R_2)}{R_2}$$

Where, $V_{\text{ref}} = 3\text{V}$

$R_2 = 3.3\text{k}\Omega$

Output voltage is

$$\begin{cases} V_{\text{OUT}} = 0.9 \times 10^{-3} \times R_1 + 3(\text{V}) \\ V_{\text{IN}} > V_{\text{OUT}} + 2 \end{cases}$$

Output voltage setting range is 3.3 ~ 33V.

T-58-11-23

TA7089P**3. Power Dissipation**

Internal power dissipation P_D in IC at normal operation is

$$P_D = V_{IN} \times I_B + (V_{IN} - V_{OUT}) \times I_{OUT}$$

Where, $\left\{ \begin{array}{ll} I_B & : \text{Bias Current} \\ V_{OUT} & : \text{Output Voltage} \end{array} \right.$ $\left\{ \begin{array}{ll} V_{IN} & : \text{Input Voltage} \\ I_{OUT} & : \text{Output Current} \end{array} \right.$

Power dissipation at output shorted condition.

$$P_D = (I_{SC} + I_B) V_{IN}$$

Max. Power dissipation P_D MAX. must be as follows :

$$P_D \text{ MAX.} < \frac{T_j \text{ MAX.} - T_a}{R_{th}}$$

Where, T_j MAX. ; Junction Temperature

T_a ; Ambient Temperature

R_{th} ; Thermal Resistance

T_j MAX. and R_{th} of the TA7089P are ;

$$T_j \text{ MAX.} = 125^\circ\text{C}$$

$$R_{th} = 165^\circ\text{C/W (Free Air)}$$

4. Rang of Output Current

Rang of output current is 0~200mA.

When output current is above 200mA, use external transistors.

(See Application circuits.)

5. Control of Output Current

The TA7089P has a build-in output current limiting transistor and is therefore capable of constant current and fold back current limiting.

The constant current is limited as shown in the following diagrams.

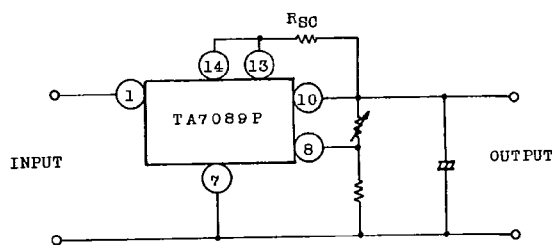

OVER CURRENT PROTECTIVE CHARACTERISTICS

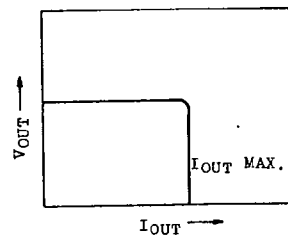

T-58-11-23

Output current is limited at a point where voltage in RSC drops to voltage between the transistor base and emitter V_{BE} (about 0.65V at $T_j=25^\circ\text{C}$)

$$RSC = \frac{V_{BE}}{I_{OUT\ MAX.}} \quad \text{Where, } V_{BE} = V_{BE}(T_j=25^\circ\text{C}) - 2 \times 10^{-3} (T_j - 25)$$

6. Phase Compensating Capacitor

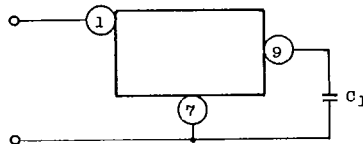

Select a capacitor having capacity 0.1 μF -1000pF according to the external wiring conditions. Normally, use a capacitor at 1000pF.

7. Output Capacitors

Output capacitors of 10 μF and 0.1 μF shall be mounted parallelly.

TA7089P

T-58-11-23

DECISION CHART OF RESISTOR R_1

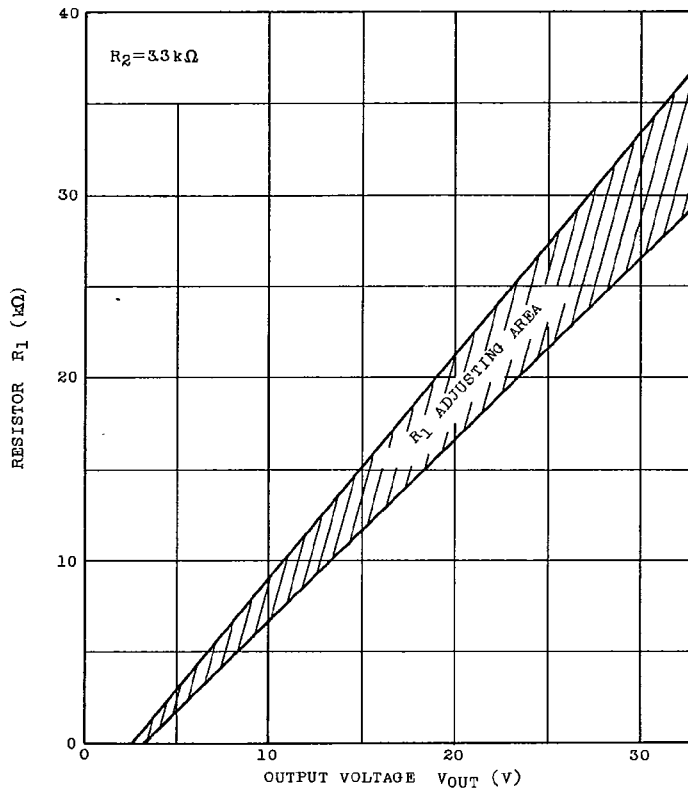

TA7089P

T-58-11-23

BASIC EXAMPLE OF 10 μ F MOUNTING OF TA7089P ON PRINTED CIRCUIT BOARD
(LOCAL REGULATOR APPLICATION)

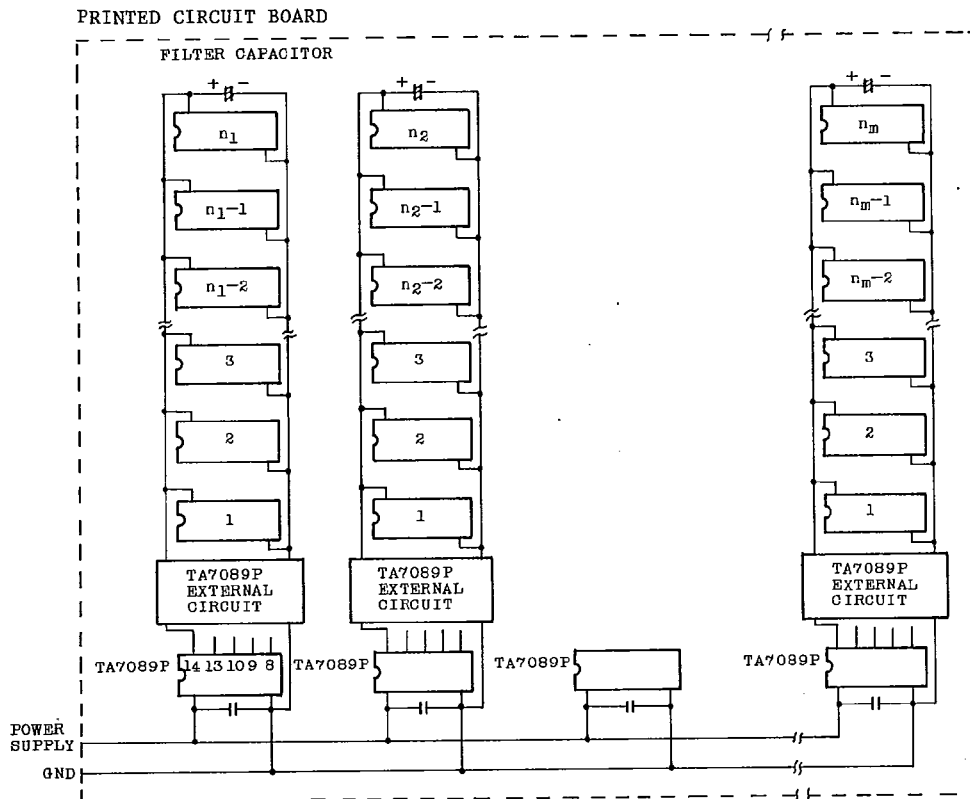

ADVANTAGES

- . Mutual effect between rows can be ignored.
- . Adjustment is simple as malfunction due to noise is reduced.
- . Pattern design is simple as the pin arrangement is 14 pins for output, 7 pins for GND and 1 pin for input.
- . THL. IC, TTL. IC and other supply voltages can be incorporated into a same printed circuit board.

TA7089P

T-58-11-23

APPLICATION (1)

1. Circuit Diagram

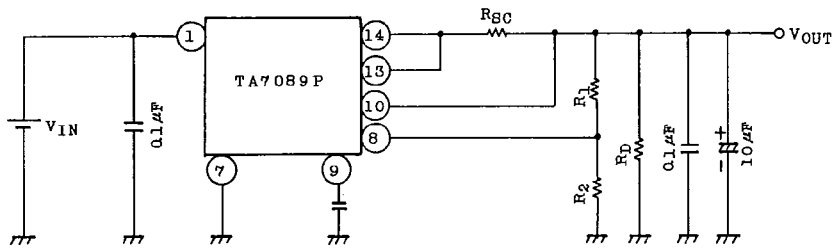

2. Decision of Circuit Constant

Circuit specification

- . Output Voltage $V_{OUT}=6V$
- . Max. Output Current $I_{OUT\ MAX.}=50mA$
- . Output Limiting Current $I_{SC}=70mA$

Decision of voltage dividing resistors R_1 and R_2

A resistor of $3.3k\Omega$ is used as R_2 by considering current balance of a differential amplifier.

R_1 is obtained from the following expression or the resistor R_1 set-up table.

$$V_{OUT} = \frac{R_1 + R_2}{R_2} \times V_{ref}$$

V_{ref} is in the range of $2.7\sim 3.3V$ from the specification.

When R_1 is obtained through calculation according to the above, it is

$$2.7k\Omega \leq R_1 \leq 4.4k\Omega$$

Further, $3\sim 4k\Omega$ is obtained from the R_1 set up table.

Therefore, Resistor R_1 would be $3k\Omega$ (fixed) + $1k\Omega$ (variable resistor).

Decision of R_{SC} .

Current limiting resistor R_{SC} value is obtained from the following expression :

$$V_{BE} = R_{SC} \times I_{SC}$$

V_{BE} : Base to emitter voltage of an internal current limiting transistor.

T-58-11-23

TA7089P

A value at $T=T_j$ is applied.

Assuming that a value of V_{BE} (at $T_j=125^\circ\text{C}$) is 0.45V, R_{SC} is 6.4Ω when $I_{SC}=70\text{mA}$ is substituted.

Decision of Min. Input Voltage

Min. input voltage $V_{IN\text{ MIN.}}$ which is required to operate this circuit is

$$V_{IN\text{ MIN.}} = V_{OUT} + |V_{IN} - V_{OUT}| + V_R$$

$$V_R : \text{Voltage between } R_{SC}$$

Where, $V_{OUT}=6\text{V}$

$$|V_{IN} - V_{OUT}| = 2\text{V} \quad (\text{from the Electrical characteristic table})$$

$$V_R = 0.65\text{V}$$

Therefore, $V_{IN\text{ MIN.}} = 8.65\text{V}$

Decision of R_D

R_D is dummy resistor used to flow current constantly in order to operate the circuit stability.

Required current is approximately 3mA.

$$R_D = \frac{V_{OUT}}{3\text{mA}} \approx 1.8\text{k}\Omega$$

Calculation of P_D

At the normal condition, max. power dissipation of IC is obtained from the following expression :

$$P_D = V_{IN} \times I_B + (V_{IN} - V_{OUT}) \times I_{OUT}$$

Power dissipation at load shorted condition is obtained from the following expression :

$$P_D = V_{IN} \times I_B + (V_{IN} - V_R) \times I_{SC}$$

Designing should be made carefully by calculating power dissipation at time of load shorted, input voltage and transformers so that $P_D\text{ MAX.}$ is not exceeded.

T-5811-23

TA7089P

APPLICATION (2) CURRENT BOOST CIRCUIT EXAMPLE

1. CIRCUIT

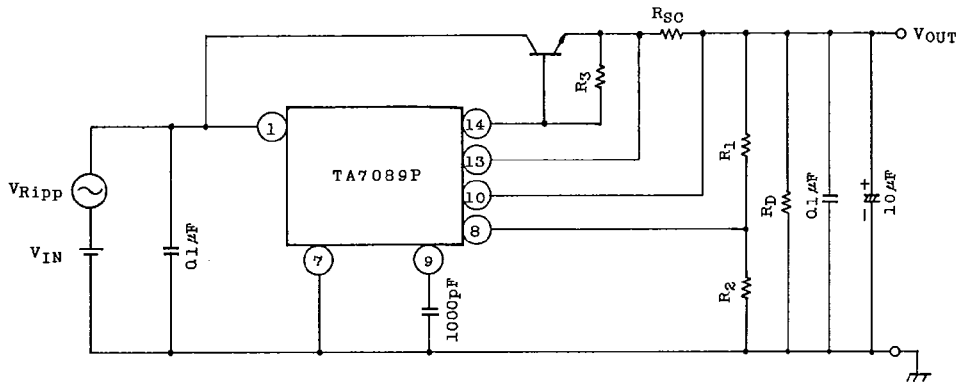

2. Decision of Circuit Constants

Circuit Specification

- . Output Voltage V_{OUT} 5V
- . Max. Output Current $I_{OUT MAX.}$ 1A
- . Current Limiting Protection Circuit

. Decision of Voltage Dividing Resistors R_1 and R_2

A resistor of 3.3k is used as R_2 by considering current balance of a differential amplifier.

R_1 is obtained from the following expression :

$$V_{OUT} = \frac{R_1 + R_2}{R_2} \times V_{ref}$$

When the resistor R_1 setting table (2) is used,

$$R_1 = 1.5k\Omega \sim 3k\Omega$$

. Therefore, R_1 would be 1.5k Ω (fixed) + 2k Ω (variable).

. Decision of R_{SC}

$$V_{BE} = R_{SC} \times I_{SC}$$

Assuming that

$$I_{SC} = 1.2A$$

$$V_{BE} = 0.65V$$

$$R_{SC} = \frac{V_{BE}}{I_{SC}} = \frac{0.45V (T_j = 125^\circ C)}{1.2} = 0.4 (\Omega)$$

T-58-11-23

A7089P

Rated capacity is

$$0.65V \times 1.2A = 0.78 (W)$$

$$R_{SC} = 0.4\Omega (1W)$$

. Decision of Min. Input Voltage

Obtained Min. input voltage of the circuit.

$$V_{IN \text{ MIN}} = V_{OUT} + |V_{IN} - V_{OUT}| + V_{BE} + V_R$$

V_R : Voltage between R_{SC}

when, V_{OUT} , $|V_{IN} - V_{OUT}|$, V_{BE} , V_R

$$\begin{aligned} \text{expression, } V_{IN \text{ MIN}} &= 5.0 + 2.0 + 0.7 + 0.6 \\ &= 8.3 (V) \end{aligned}$$

Further, as the catalog standard is 7V or above,

$$V_{IN \text{ MIN}} = 8.3 (V)$$

. Decision of R_3

Resistor R_3 is to be inserted for stabilizing the circuit and several mA would be sufficient.

When the circuit is designed by assuming that current is 5mA.

$$R_3 = \frac{V_{BE}}{5mA} = \frac{0.7V}{5mA} \doteq 150 (\Omega)$$

. Decision of R_D

Resistor R_D is used to apply dummy current and functions to stabilize the circuit together with R_3 .

1~10mA is generally accepted. The design is made here at 5mA.

$$R_D = \frac{V_{OUT}}{I_D} = \frac{5V}{5mA} = 1 (k\Omega)$$

Summary

R_2	3.3k Ω
R_1	1.5k Ω (fixed) + 2k Ω (variable)
R_{SC}	0.4 Ω (1W)
R_3	150 Ω
R_D	1k Ω
$V_{IN \text{ MIN}}$	8.3V

T-58-11-23

TA7089P**3. Parasitic Oscillation Prevention**

To prevent a parasitic oscillation, insert a capacitor of about $0.1\mu\text{F}$ into the input and output sides. It would be effective when the capacitor is insert as close as to IC terminals.

4. Example of Output Voltage Ripple Value Calculation

Assuming that input ripple voltage is $3\text{ V}_{\text{p-p}}$ AC,

$$V_{\text{IN}} = 10\text{V}_{\text{DC}} + 3\text{V}_{\text{p-p}} \text{ AC}$$

However, actual mean value of full load input voltage when voltage fluctuation at the transformer primary side is considered is 12V DC .

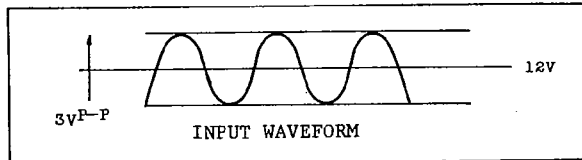

Obtain output ripple voltage.

As Reg. in is min. $40(\text{dB})$ from the standard data table,

$$(\text{Output ripple voltage}) = 30\text{mV}_{\text{p-p}} \text{ AC.}$$

5. Selection of Power Transistor

Full Load Input Voltage	12V (AVG)
Output Voltage	5V
Output Current	1A

When $P_{\text{D MAX}}$ is obtained from the above data,

$$\begin{aligned} P_{\text{D MAX}} &= (12-5) \times 1 \\ &= 7 \text{ (W)} \end{aligned}$$

However, when power dissipation resulted from output short is calculated.

$$P_{\text{D MAX}} = 12 \times 1.2 = 14.4 \text{ (W)}$$

2SD867 (or equivalent) is selected this time from TOSHIBA SEMICONDUCTOR HAND BOOK.

6. Design of Heat Sink

1) Design of power transistor radiation

From the 2SD 867 data table (TOSHIBA SEMICONDUCTOR HAND BOOK)

$$R_{th(j-c)} = \frac{150-25}{100} = 1.25^{\circ}\text{C/W}$$

Therefore, $R_{th(j-a)} = 1.25 + 1.0 + R_{th(f)}$

(It is assumed that $R_{th(s)} + R_{th(c)} = 1.0^{\circ}\text{C/W}$)

$P_D \text{ MAX} = 14.4\text{W}$ $T_j \text{ MAX} = 150^{\circ}\text{C}$ $T_a = 60^{\circ}\text{C}$ (Including temperature rise in device)
--

From the above data,

$$R_{th(j-a)} = \frac{T_j \text{ MAX} - T_a}{P_D \text{ MAX}} = \frac{150-60}{14.4} = 6.2^{\circ}\text{C/W}$$

Accordingly, thermal resistance required for a heat sink is,

$$\begin{aligned} R_{th(f)} &= R_{th(j-a)} - R_{th(j-c)} - R_{th(s)} - R_{th(c)} \\ &= 6.2 - 1.25 - 1.0 \\ &= 3.95^{\circ}\text{C/W} \end{aligned}$$

When an Al heat sink is used, size required can be seen as follows from TOSHIBA SEMICONDUCTOR HAND BOOK :

$$100\text{mm} \times 170\text{mm} \times 2\text{mm}$$

Further, in actual designing it is a general practice to derate $T_j \text{ MAX}$ taking reliability into consideration.

2) Design of IC Heat Sinking

Max. power consumed in IC is obtained from the following expression :

$$P_D \text{ MAX} = (V_{IN \text{ MAX}} - V_{BE(1)}) \times \left(\frac{I_{SC} - V_{BE(2)}/R_3}{h_{FE(\text{MIN})}} + \frac{V_{BE(2)}}{R_3} + I_B \text{ MAX} \right)$$

Assuming that

$V_{BE(1)}$: V_{BE} of current limiting internal transistor = 0.65V

$V_{BE(2)}$: V_{BE} of power transistor = 0.65V

$h_{FE \text{ MIN}}$: Min. value of h_{FE} of power transistor
(at $I_C = I_{SC}$) $\doteq 40$

$I_B \text{ MAX}$: Max. value of bias current of TA7089P = 6mA

$P_D \text{ MAX}$ is above 504mW.

T-58-11-23

TA7089P

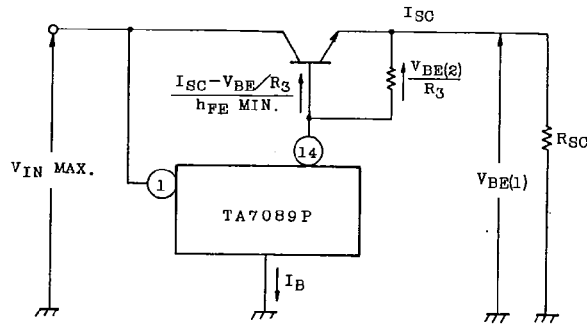

7. Application

Specification

- V_{IN} 12V_{DC} + 3V_{P-PAC}
- V_{OUT} 5V_{DC} + 30mV_{P-PAC}
- I_L MAX 1.2A

Current limiting protection circuit

Example 1. Current Boost Circuit

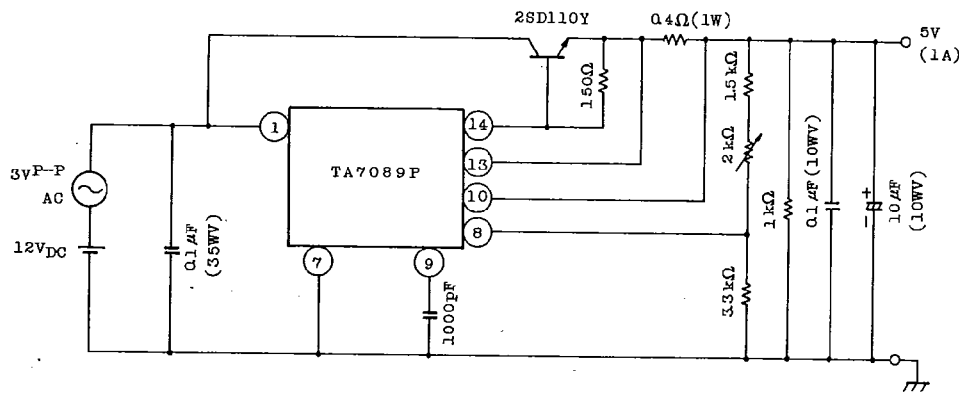

2SD876 Heat Sink ($R_{th(f)} = 3.95^{\circ}\text{C/W}$)
 100 × 170 × 2mm Al

TA7089P

T-58-11-23

Example 2. Positive and Negative Power Supplied

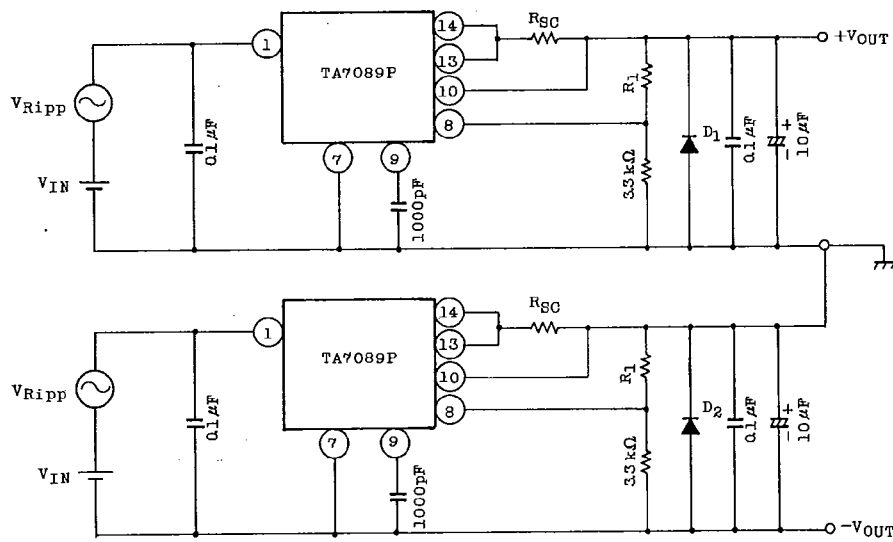

Use diodes having less forward voltage drop for D₁ and D₂.

Copyright Each Manufacturing Company.

All Datasheets cannot be modified without permission.

This datasheet has been download from :

www.AllDataSheet.com

100% Free DataSheet Search Site.

Free Download.

No Register.

Fast Search System.

www.AllDataSheet.com