

MITSUBISHI RF POWER TRANSISTOR
2SC3379

NPN EPITAXIAL PLANAR TYPE

DESCRIPTION

2SC3379 is a silicon NPN epitaxial planar type transistor specifically designed for UHF power amplifier applications.

FEATURES

- High power gain: $G_{pe} \geq 6.7\text{dB}$
@ $V_{CC} = 7.2\text{V}$, $f = 520\text{MHz}$, $P_{in} = 0.6\text{W}$.
- Emitter ballasted construction.
- High ruggedness: Ability to withstand more than 20:1 load VSWR when operated at $V_{CC} = 9\text{V}$, $f = 520\text{MHz}$, $P_O = 2.8\text{W}$.
- Flange type ceramic package.

APPLICATION

For output stage of 1 – 2W power amplifiers in UHF band portable type radio sets.

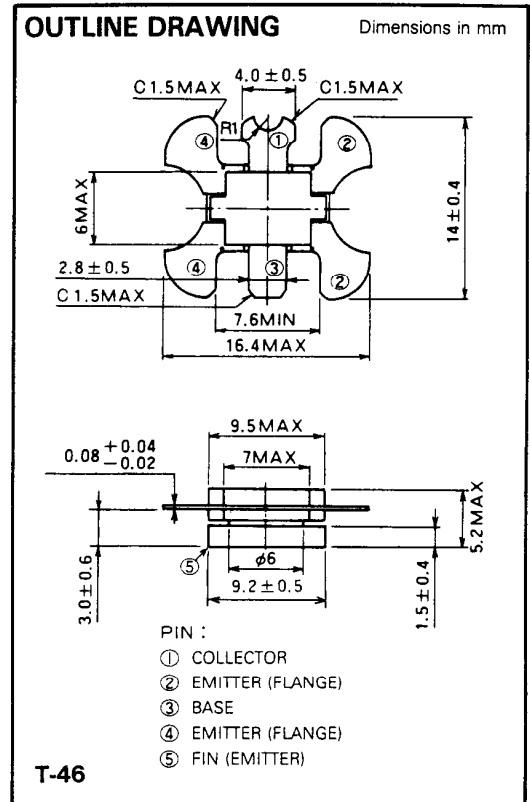

ABSOLUTE MAXIMUM RATINGS ($T_C = 25^\circ\text{C}$)

Symbol	Parameter	Conditions	Ratings	Unit
V_{CBO}	Collector to base voltage		20	V
V_{EBO}	Emitter to base voltage		3.5	V
V_{CEO}	Collector to emitter voltage	$R_{BE} = \infty$	9	V
I_C	Collector current		1.5	A
P_C	Collector dissipation	$T_C = 25^\circ\text{C}$	10	W
T_j	Junction temperature		175	$^\circ\text{C}$
T_{stg}	Storage temperature		-55 to 175	$^\circ\text{C}$
R_{th-c}	Thermal resistance	Junction to case	15	$^\circ\text{C/W}$

Note. Above parameters are guaranteed independently.

ELECTRICAL CHARACTERISTICS ($T_C = 25^\circ\text{C}$)

Symbol	Parameter	Test conditions	Limits			Unit
			Min	Typ	Max	
$V_{(BR)EBO}$	Emitter to base breakdown voltage	$I_E = 1\text{mA}$, $I_C = 0$	3.5			V
$V_{(BR)CBO}$	Collector to base breakdown voltage	$I_C = 10\text{mA}$, $I_E = 0$	20			V
$V_{(BR)CEO}$	Collector to emitter breakdown voltage	$I_C = 10\text{mA}$, $R_{BE} = \infty$	9			V
I_{CBO}	Collector cut-off current	$V_{CB} = 10\text{V}$, $I_E = 0$			300	μA
I_{EBO}	Emitter cut-off current	$V_{EB} = 2\text{V}$, $I_C = 0$			300	μA
h_{FE}	DC forward current gain*	$V_{CE} = 5\text{V}$, $I_C = 0.1\text{A}$	10	50	180	—
P_O	Power Output	$V_{CC} = 7.2\text{V}$, $P_{in} = 0.6\text{W}$, $f = 520\text{MHz}$	2.8	3.2		W
η_C	Collector efficiency		55	60		%

Note. * Pulse test, $P_W = 150\mu\text{s}$, duty = 5%.

Above parameters, ratings, limits and conditions are subject to change.

TEST CIRCUIT (f = 520MHz)

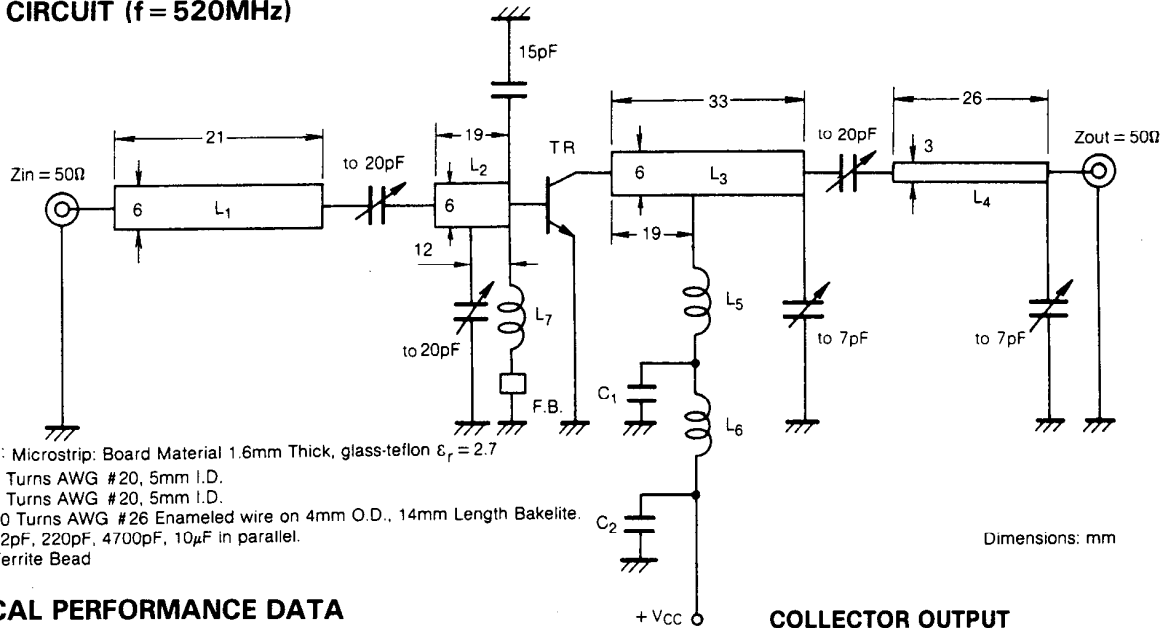

TYPICAL PERFORMANCE DATA

COLLECTOR DISSIPATION VS. CASE TEMPERATURE

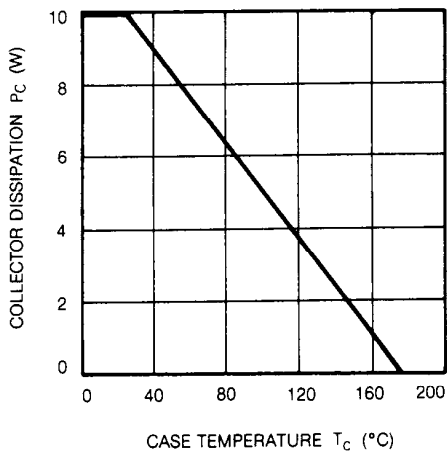

COLLECTOR OUTPUT CAPACITANCE VS. COLLECTOR TO BASE VOLTAGE

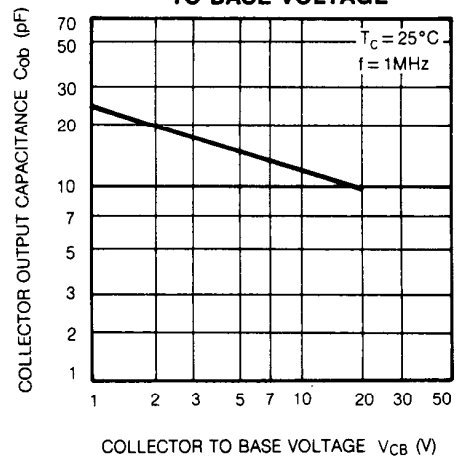

OUTPUT POWER, COLLECTOR EFFICIENCY VS. INPUT POWER

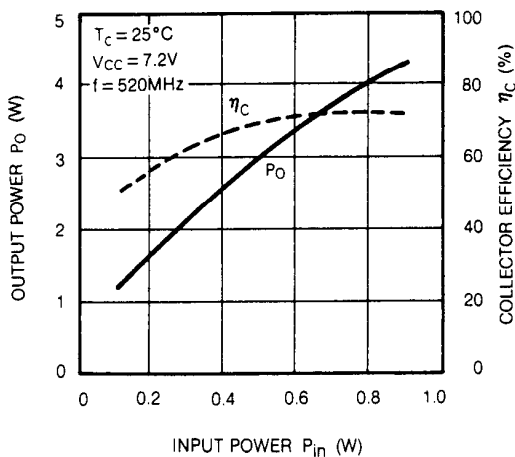

OUTPUT POWER VS. COLLECTOR SUPPLY VOLTAGE

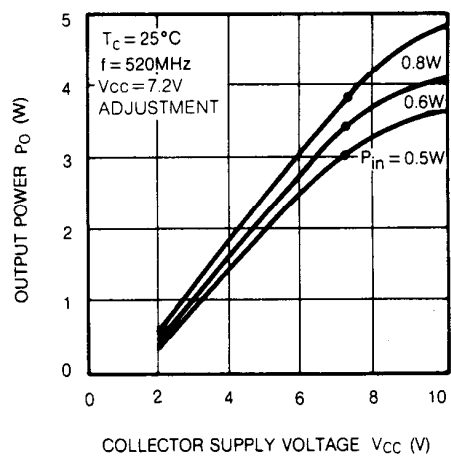

OUTPUT POWER VS. FREQUENCY

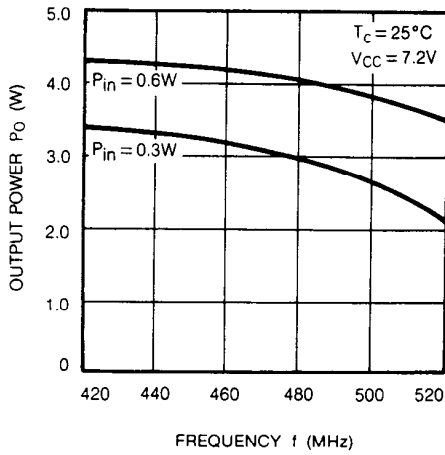

SERIES INPUT AND OUTPUT IMPEDANCE VS. FREQUENCY

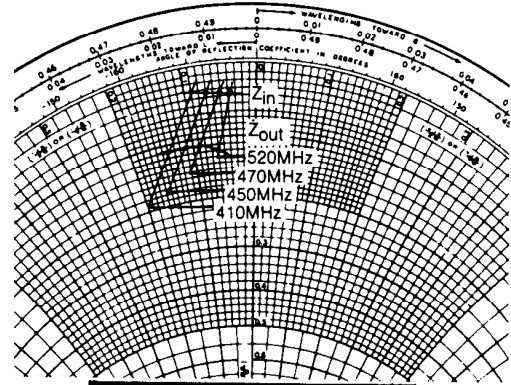

f (MHz)	Z _{in} (Ω)	Z _{out} (Ω)
410	1.5 - j4.5	5.5 - j7.0
450	1.5 - j3.5	5.3 - j5.5
470	1.6 - j2.5	5.4 - j4.5
520	1.8 - j1.9	6.0 - j3.0

$V_{CC} = 7.2\text{V}, P_o = 2.8\text{W}$

PRECAUTIONS FOR MOUNTING HIGH-FREQUENCY HIGH-OUTPUT TRANSISTOR FOR MOBILE RADIO EQUIPMENT

When mounting high-frequency, high-output transistors for mobile radio equipment (flange screw fastening part cut package), care should be taken to the following points.

1. When mounting the device to the heat sink, silicon compound should be applied to the heat sink and device heat radiating fin and apply the device to the heat sink using a proper fastening tool.
2. If the device is soldered directly to heat sink, excessive thermal stress will result in deteriorating the reliability. Do not use this mounting method.
3. Care should be taken, if the device is applied to the heat sink, the force of soldering the leads to the printed circuit board results in continual mechanical stress, deteriorating the reliability and performance of the system.
4. Refer to Mitsubishi's DATABOOK or manuals for transistors, small-signal diodes and integrated circuit modules for mounting and handling of the device.