

OUTLINE

The R1111N Series are CMOS-based voltage regulator ICs with high output voltage accuracy, extremely low supply current, low ON-resistance, and high Ripple Rejection. Each of these voltage regulator ICs consists of a voltage reference unit, an error amplifier, resistors, a current limit circuit, and a chip enable circuit.

These ICs perform with low dropout voltage and a chip enable function. The line transient response and load transient response of the R1111N Series are excellent, thus these ICs are very suitable for the power supply for hand-held communication equipment.

The output voltage of these ICs is fixed with high accuracy. Since the package for these ICs is SOT-23-5 (Mini-mold) package, high density mounting of the ICs on boards is possible.

FEATURES

- Ultra-Low Supply Current Typ. $35\mu\text{A}$
- Standby Mode Typ. $0.1\mu\text{A}$
- Low Dropout Voltage Typ. 0.2V ($I_{\text{OUT}}=100\text{mA}$)
- High Ripple Rejection Typ. 70dB ($f=1\text{kHz}$)
- Low Temperature-Drift Coefficient of Output Voltage..... Typ. $\pm 100\text{ppm}/^\circ\text{C}$
- Excellent Line Regulation..... Typ. $0.05\%/V$
- High Output Voltage Accuracy $\pm 2.0\%$
- Excellent Line Transient Response and Load Transient Response
- Small Package SOT-23-5(Mini-mold)
- Output Voltage..... Stepwise setting with a step of 0.1V in the range of 1.5V to 5.0V is possible
- Built-in chip enable circuit (2 types; A: active “L”, B: active “H”)
- Pin out..... Similar to the LP2980

APPLICATIONS

- Power source for cellular phones such as GSM,CDMA and various kind of PCSs.
- Power source for electrical appliances such as cameras, VCRs and camcorders.
- Power source for battery-powered equipment.

BLOCK DIAGRAM

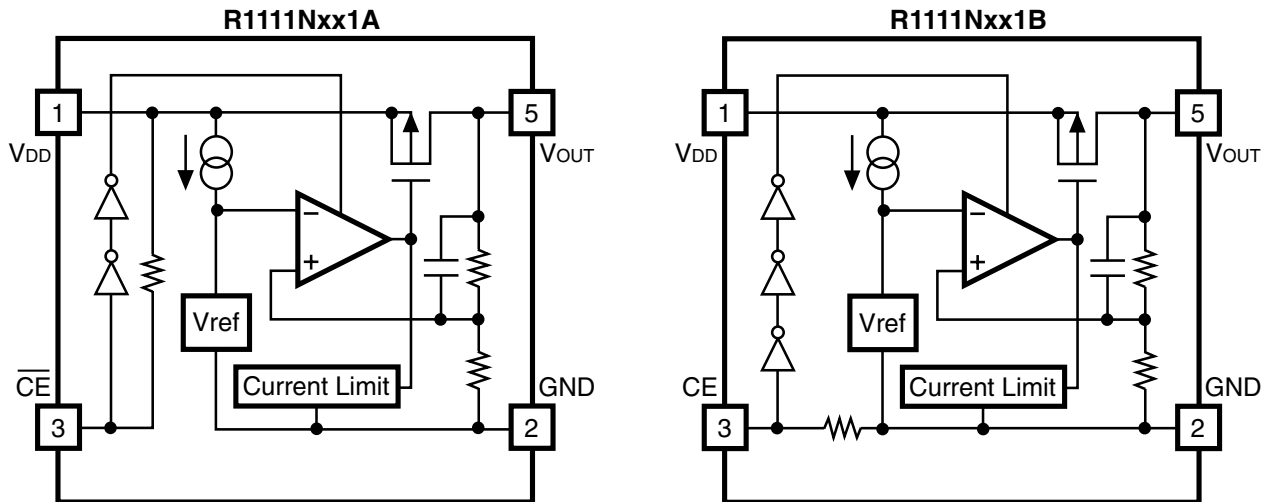

SELECTION GUIDE

The output voltage, the active type, the packing type, and the taping type for the ICs can be selected at the user's request. The selection can be made by designating the part number as shown below :

R1111xxx1x-xx ← Part Number
 ↑↑ ↑↑
 a b c d

Code	Contents
a	Designation of Package Type : N:SOT-23-5 (Mini-mold)
b	Setting Output Voltage (V _{OUT}) : Stepwise setting with a step of 0.1V in the range of 1.5V to 5.0V is possible.
c	Designation of Active Type : A :“L” active type B :“H” active type
d	Designation of Taping Type : Ex. TR, TL (refer to Taping Specifications ;TR type is the standard direction.)

PIN CONFIGURATION

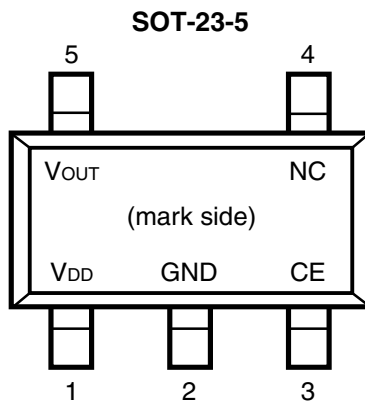

PIN DESCRIPTION

Pin No.	Symbol	Description
1	V_{DD}	Input Pin
2	GND	Ground Pin
3	\overline{CE} or CE	Chip Enable Pin
4	NC	No Connection
5	V_{OUT}	Output pin

ABSOLUTE MAXIMUM RATINGS

Item	Symbol	Rating	Unit
Input Voltage	V_{IN}	9	V
Input Voltage (\overline{CE} or CE Pin)	V_{CE}	-0.3 ~ $V_{IN}+0.3$	V
Output Voltage	V_{OUT}	-0.3 ~ $V_{IN}+0.3$	V
Output Current	I_{OUT}	200	mA
Power Dissipation	P_D	250	mW
Operating Temperature Range	T_{opt}	-40 ~ 85	°C
Storage Temperature Range	T_{stg}	-55 ~ 125	°C

ELECTRICAL CHARACTERISTICS

• R1111Nxx1A

T_{opt}=25°C

Symbol	Item	Conditions	Min.	Typ.	Max.	Unit
V _{OUT}	Output Voltage	V _{IN} = Set V _{OUT} +1V 1mA ≤ I _{OUT} ≤ 30mA	V _{OUT} ×0.98		V _{OUT} ×1.02	V
I _{OUT}	Output Current	Refer to the ELECTRICAL CHARACTERISTICS by OUTPUT VOLTAGE				
ΔV _{OUT} /ΔI _{OUT}	Load Regulation	V _{IN} = Set V _{OUT} +1V 1mA ≤ I _{OUT} ≤ 80mA		12	40	mV
V _{DIF}	Dropout Voltage	Refer to the ELECTRICAL CHARACTERISTICS by OUTPUT VOLTAGE				
I _{SS}	Supply Current	V _{IN} = Set V _{OUT} +1V		35	70	μA
I _{standby}	Supply Current (Standby)	V _{IN} = V _{CE} = Set V _{OUT} +1V		0.1	1.0	μA
ΔV _{OUT} /ΔV _{IN}	Line Regulation	Set V _{OUT} +0.5V ≤ V _{IN} ≤ 8V I _{OUT} = 30mA		0.05	0.20	%/V
RR	Ripple Rejection	f = 1kHz, Ripple 0.5Vp-p V _{IN} = Set V _{OUT} +1V		70		dB
V _{IN}	Input Voltage		2		8	V
ΔV _{OUT} /ΔT	Output Voltage Temperature Coefficient	I _{OUT} = 30mA -40°C ≤ T _{opt} ≤ 85°C		±100		ppm /°C
I _{lim}	Short Current Limit	V _{OUT} = 0V		50		mA
R _{PU}	$\overline{\text{CE}}$ Pull-up Resistance		2.5	5.0	10.0	MΩ
V _{CEH}	$\overline{\text{CE}}$ Input Voltage "H"		1.5		V _{IN}	V
V _{CEL}	$\overline{\text{CE}}$ Input Voltage "L"		0.00		0.25	V
e _n	Output Noise	BW = 10Hz ~ 100kHz		30		μV _{rms}

• R1111Nxx1B

Topt=25°C

Symbol	Item	Conditions	Min.	Typ.	Max.	Unit
V_{OUT}	Output Voltage	$V_{IN} = \text{Set } V_{OUT} + 1V$ $1mA \leq I_{OUT} \leq 30mA$	V_{OUT} $\times 0.98$		V_{OUT} $\times 1.02$	V
I_{OUT}	Output Current	Refer to the ELECTRICAL CHARACTERISTICS by OUTPUT VOLTAGE				
$\Delta V_{OUT}/\Delta I_{OUT}$	Load Regulation	$V_{IN} = \text{Set } V_{OUT} + 1V$ $1mA \leq I_{OUT} \leq 80mA$		12	40	mV
V_{DIF}	Dropout Voltage	Refer to the ELECTRICAL CHARACTERISTICS by OUTPUT VOLTAGE				
I_{SS}	Supply Current	$V_{IN} = \text{Set } V_{OUT} + 1V$		35	70	μA
Istandby	Supply Current (Standby)	$V_{IN} = \text{Set } V_{OUT} + 1V$ $V_{CE} = GND$		0.1	1.0	μA
$\Delta V_{OUT}/\Delta V_{IN}$	Line Regulation	Set $V_{OUT} + 0.5V \leq V_{IN} \leq 8V$ $I_{OUT} = 30mA$		0.05	0.20	%/V
RR	Ripple Rejection	$f = 1KHz$, Ripple 0.5Vp-p $V_{IN} = \text{Set } V_{OUT} + 1V$		70		dB
V_{IN}	Input Voltage		2		8	V
$\Delta V_{OUT}/\Delta T$	Output Voltage Temperature Coefficient	$I_{OUT} = 30mA$ $-40^{\circ}C \leq T_{opt} \leq 85^{\circ}C$		± 100		ppm/ $^{\circ}C$
I_{lim}	Short Current Limit	$V_{OUT} = 0V$		50		mA
R_{PD}	CE Pull-down Resistance		2.5	5.0	10.0	$M\Omega$
V_{CEH}	CE Input Voltage "H"		1.5		V_{IN}	V
V_{CEL}	CE Input Voltage "L"		0.00		0.25	V
en	Output Noise	$BW = 10Hz \sim 100kHz$		30		μV_{rms}

• ELECTRICAL CHARACTERISTICS by OUTPUT VOLTAGE

Topt = 25°C

Output Voltage	Output Current	
	I _{OUT} (mA)	
	Condition	Min.
1.5 ≤ V _{OUT} ≤ 1.7	V _{IN} - V _{OUT} = 1.0V	100
1.8 ≤ V _{OUT} ≤ 5.0		150

Topt = 25°C

Output Voltage V _{OUT} (V)	Dropout Voltage			
	V _{DIF} (V)			
	Condition	Min.	Typ.	Max.
1.5	I _{OUT} = 100mA	0.50		
1.6		0.40		
1.7		0.30		
1.8 ≤ V _{OUT} ≤ 1.9			0.60	1.40
2.0 ≤ V _{OUT} ≤ 2.4			0.35	0.70
2.5 ≤ V _{OUT} ≤ 2.7			0.24	0.35
2.8 ≤ V _{OUT} ≤ 3.3			0.20	0.30
3.4 ≤ V _{OUT} ≤ 5.0			0.17	0.26

OPERATION

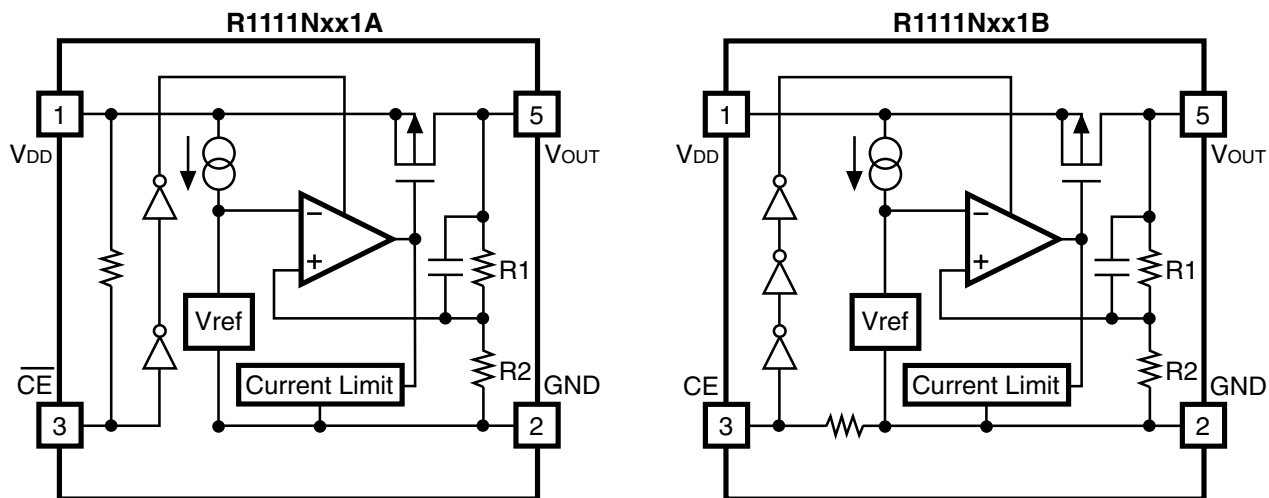

In these ICs, fluctuation of the output voltage, V_{OUT} is detected by feed-back registers R1, R2, and the result is compared with a reference voltage by the error amplifier, so that a constant voltage is output. A current limit circuit for protection at short mode and a chip enable circuit, are included.

TEST CIRCUITS

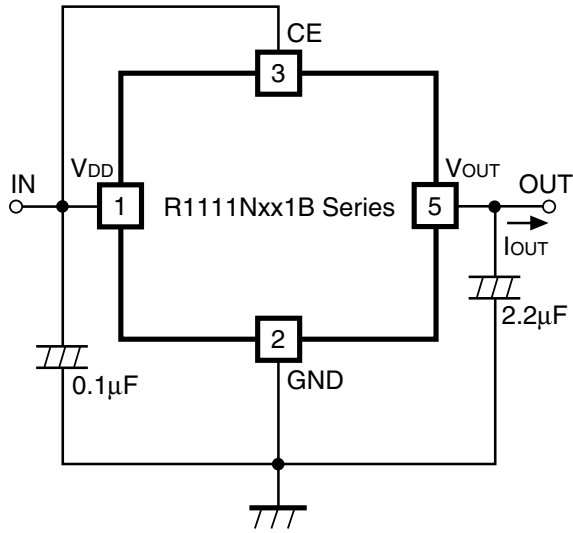

Fig.1 Standard test Circuit

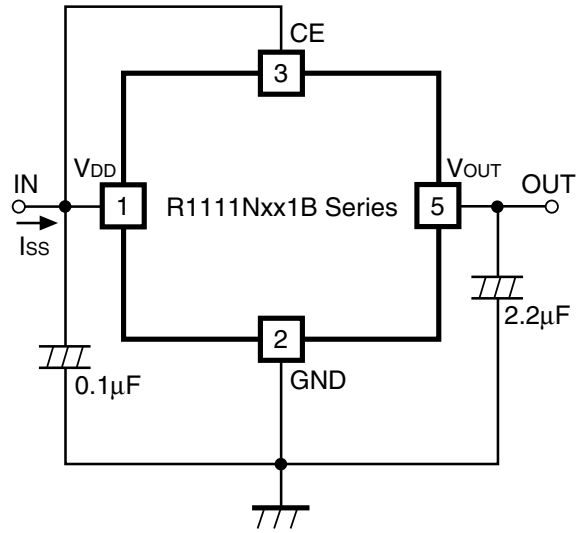

Fig.2 Supply Current Test Circuit

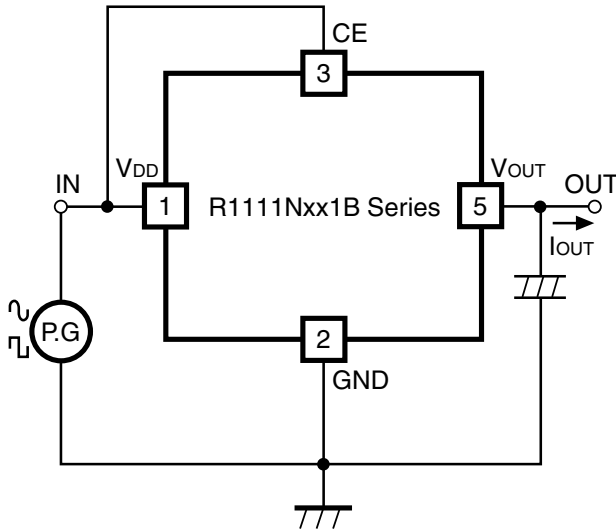

Fig.3 Ripple Rejection, Line Transient Response Test Circuit

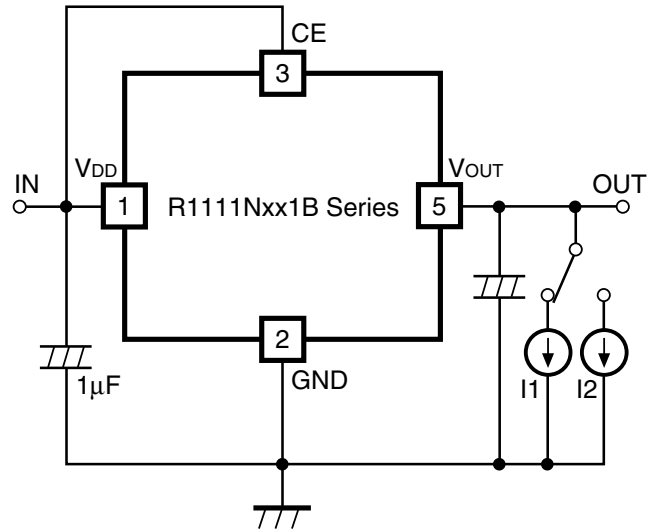
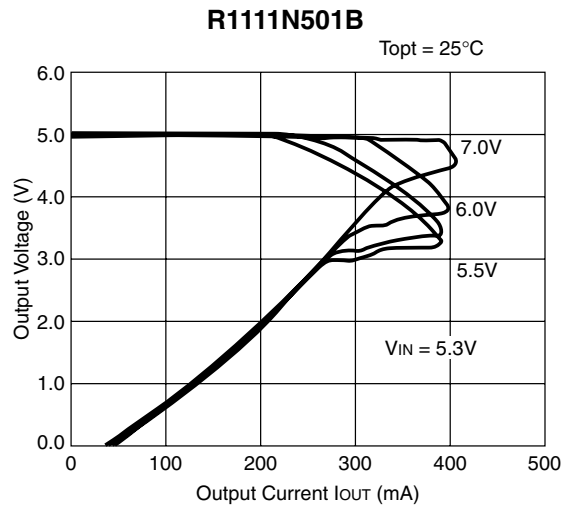
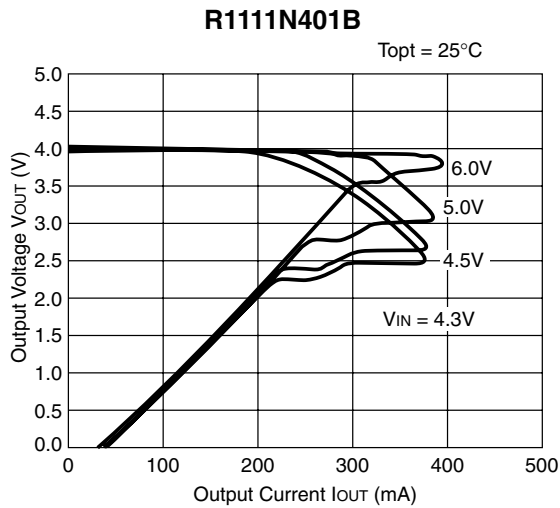
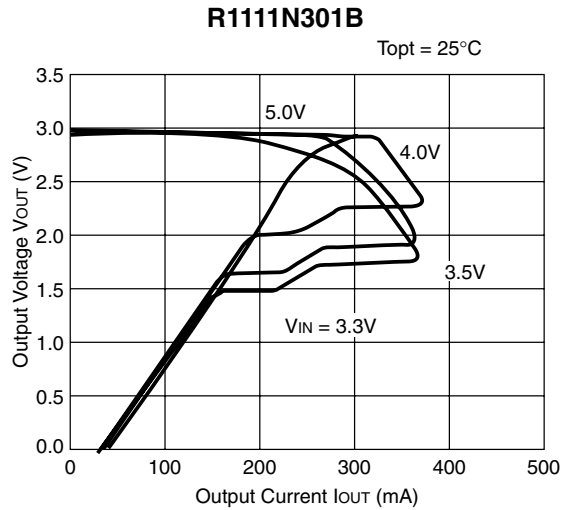
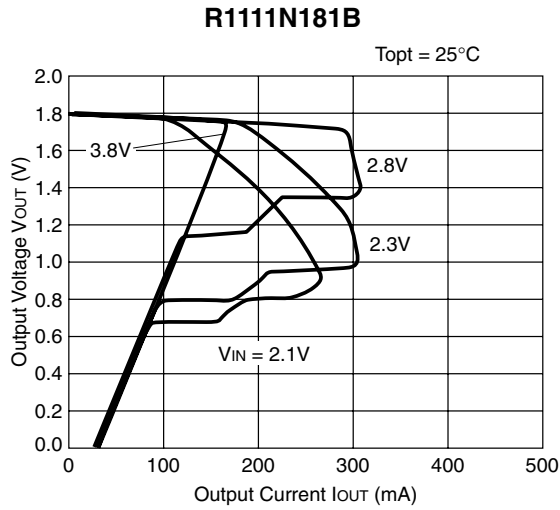

Fig.4 Load Transient Response Test Circuit

TYPICAL CHARACTERISTICS

1) Output Voltage vs. Output Current



2) Output Voltage vs. Input Voltage

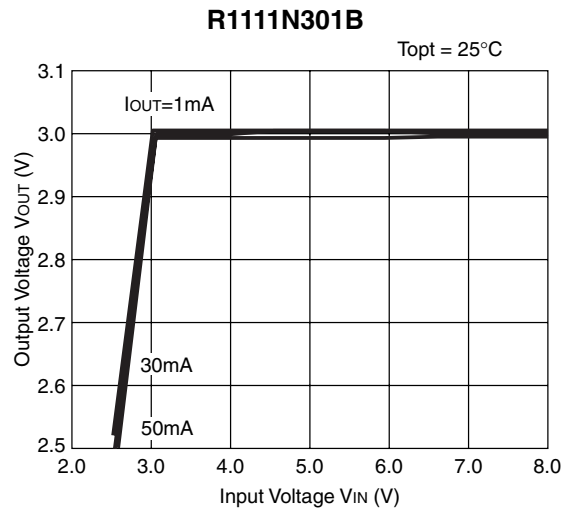
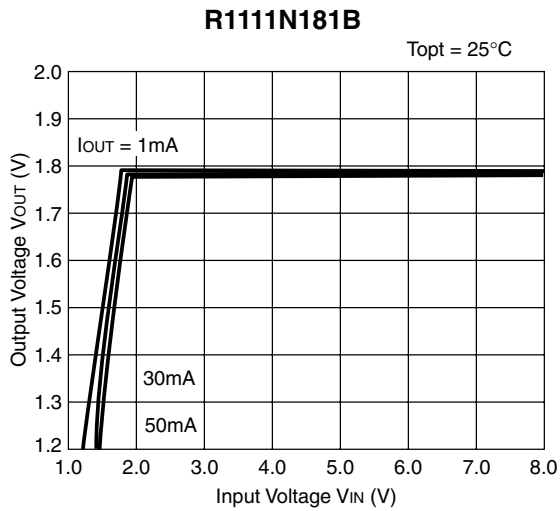

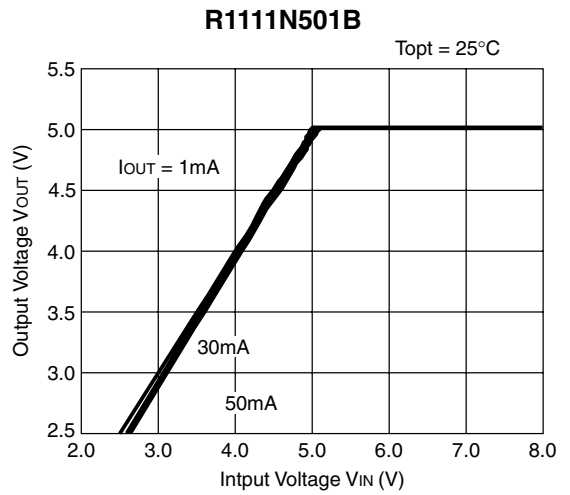
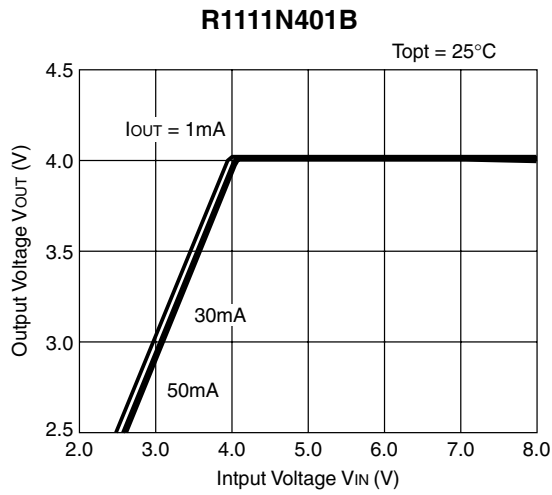

3) Dropout Voltage vs. Output Current

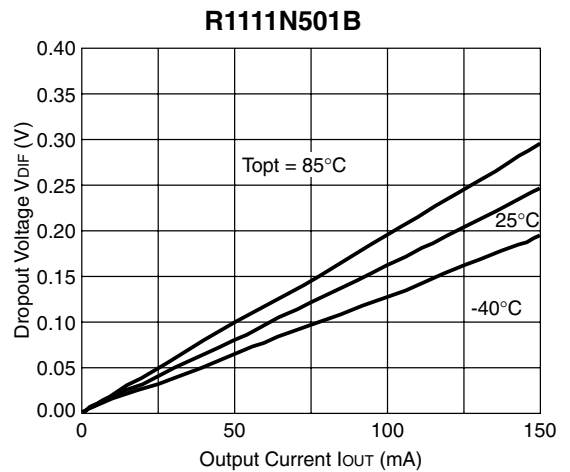
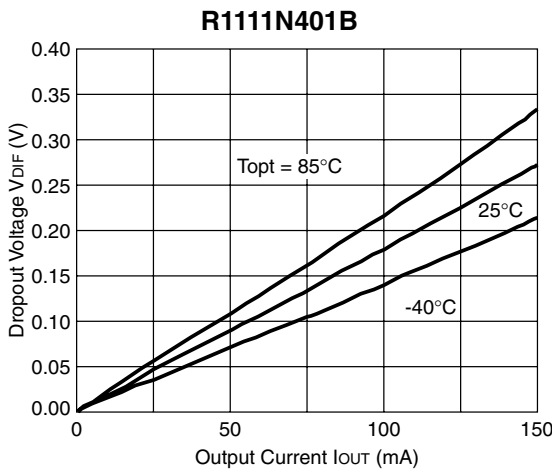
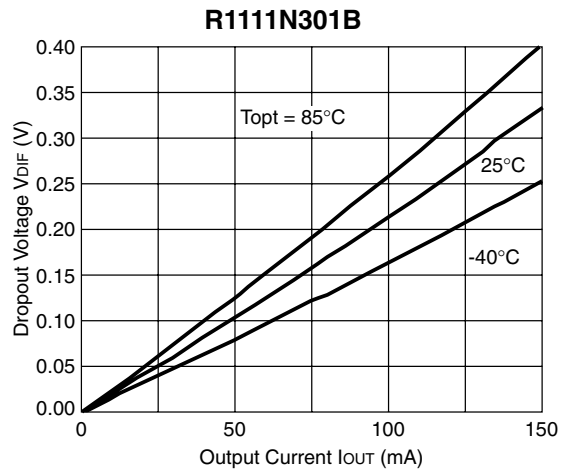
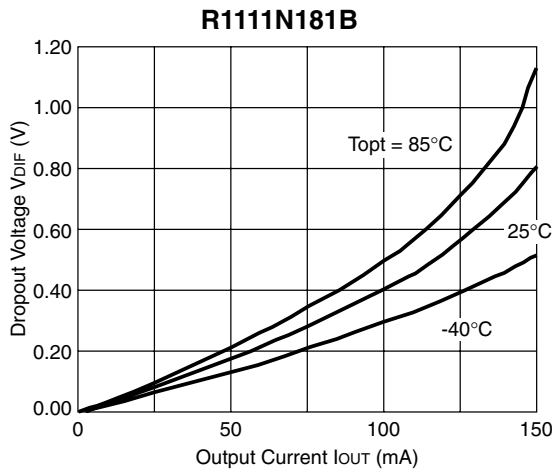

4) Output Voltage vs. Temperature

R1111N181B

$V_{IN} = 2.8V$
 $I_{OUT} = 30mA$

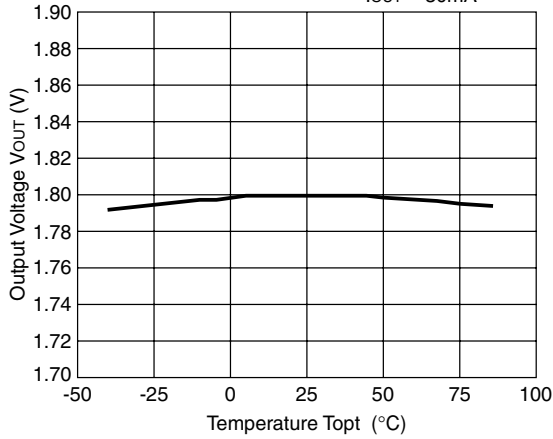

R1111N301B

$V_{IN} = 4.0V$
 $I_{OUT} = 30mA$

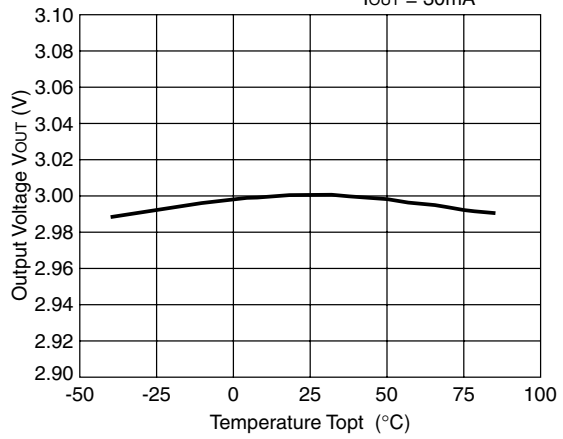

R1111N401B

$V_{IN} = 5.0V$
 $I_{OUT} = 30mA$

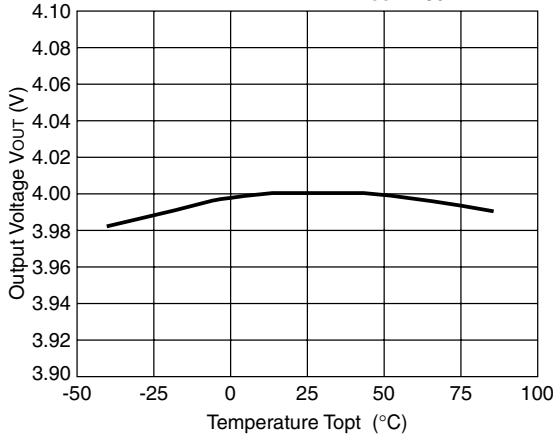

R1111N501B

$V_{IN} = 6.0V$
 $I_{OUT} = 30mA$

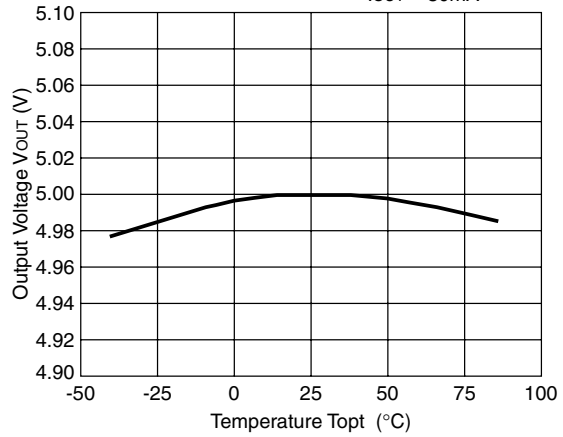

5) Supply Current vs. Input Voltage

R1111N181B

$T_{opt} = 25^\circ C$

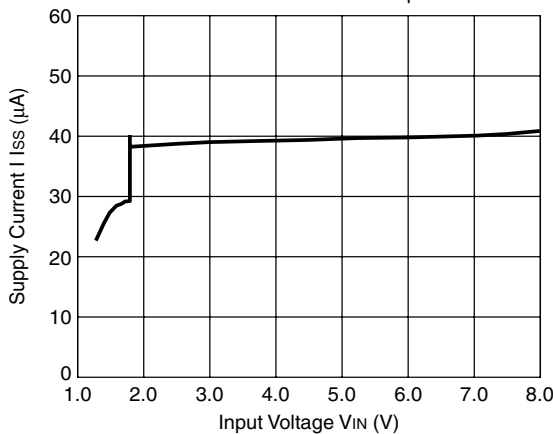

R1111N301B

$T_{opt} = 25^\circ C$

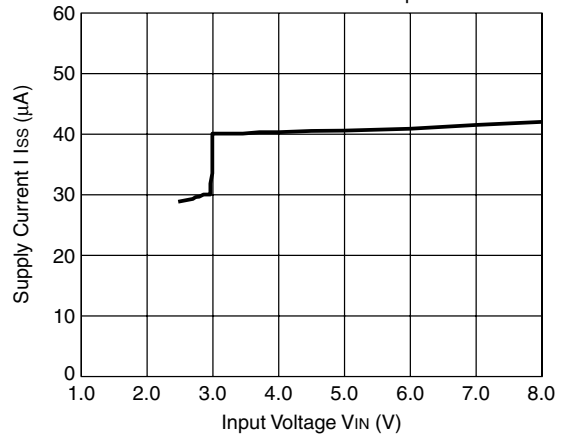

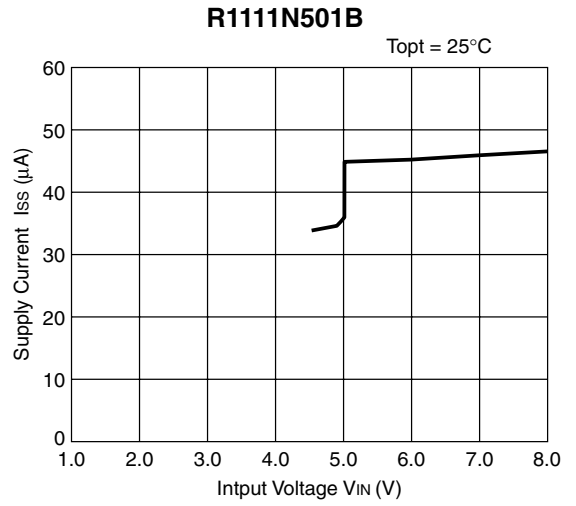
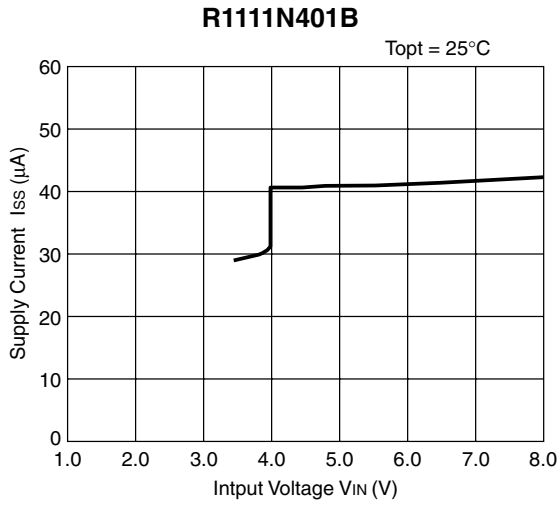

6) Supply Current vs. Temperature

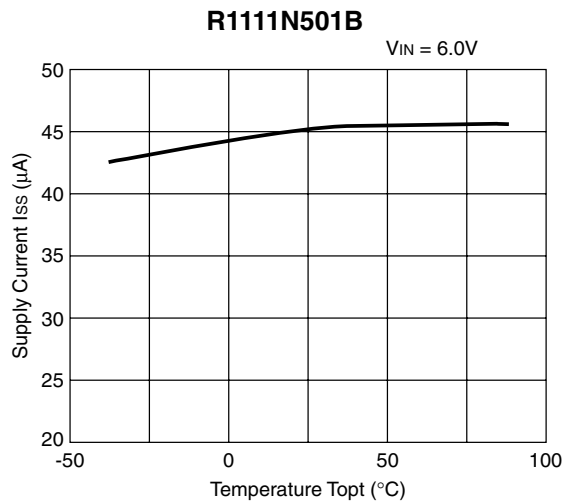
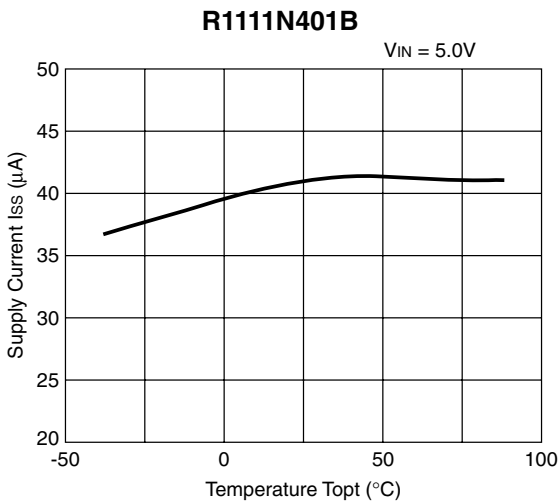
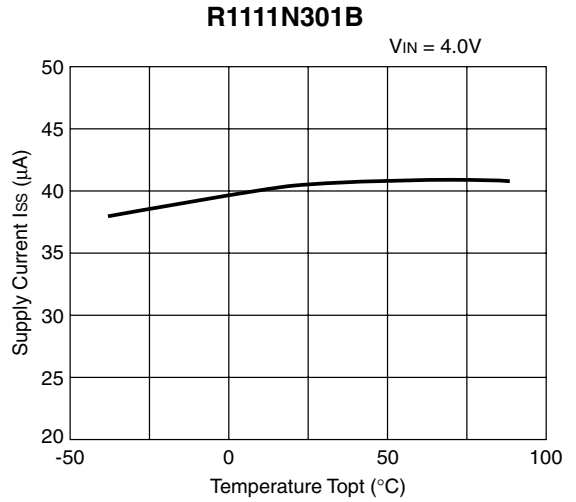
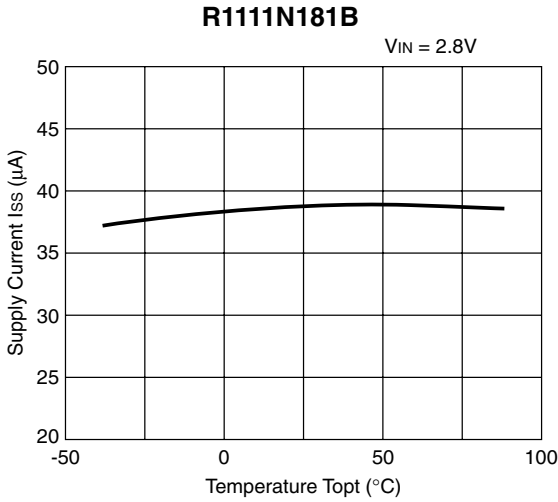

7) Dropout Voltage vs. Set Output Voltage

R1111Nxx1B

$T_{opt} = 25^{\circ}C$

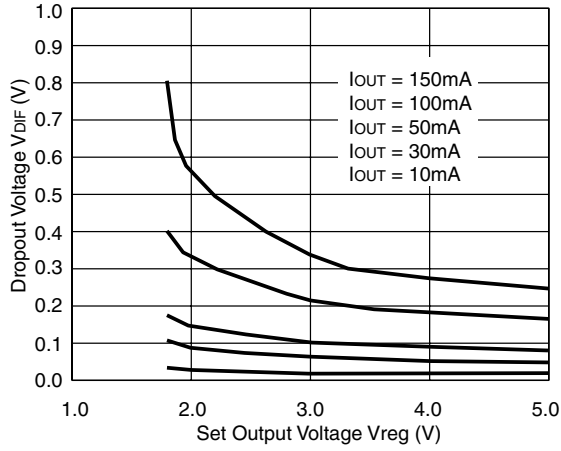

8) Ripple Rejection vs. Frequency

R1111N181B

$V_{IN} = 2.8V_{DC} + 0.5V_{p-p}$
 $C_{OUT} = \text{tantal } 1.0\mu F$

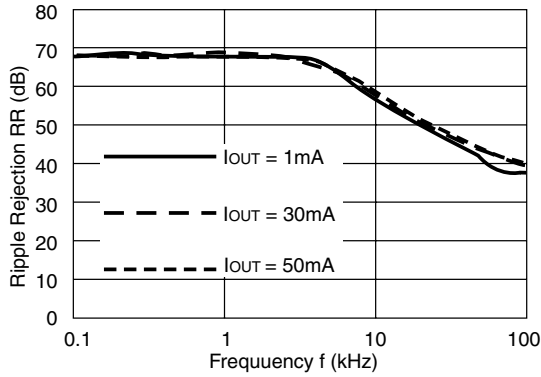

R1111N181B

$V_{IN} = 2.8V_{DC} + 0.5V_{p-p}$
 $C_{OUT} = \text{tantal } 2.2\mu F$

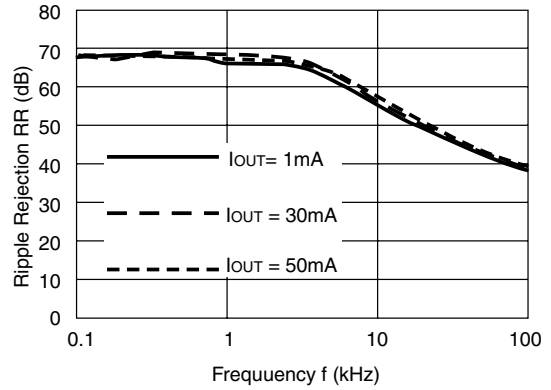

R1121N301B

$V_{IN} = 4V_{DC} + 0.5V_{p-p}$
 $C_{OUT} = \text{tantal } 1.0\mu F$

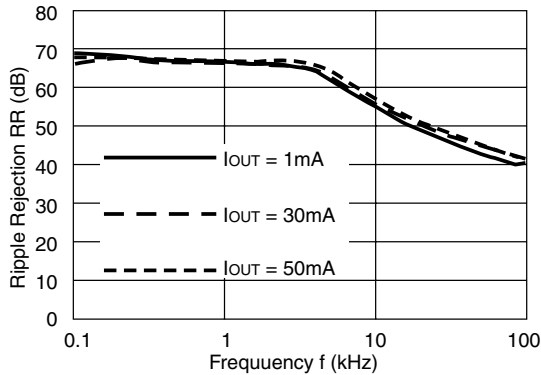

R1121N301B

$V_{IN} = 4V_{DC} + 0.5V_{p-p}$
 $C_{OUT} = \text{tantal } 2.2\mu F$

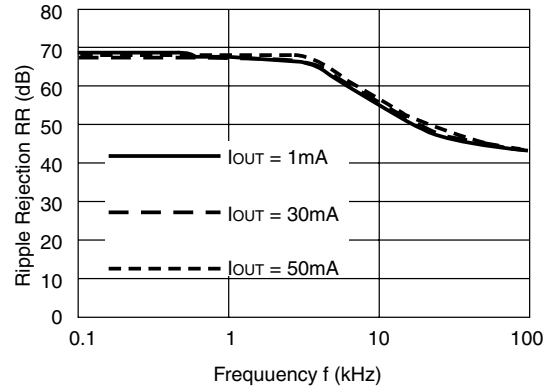

R1111N401B

$V_{IN} = 5.0V_{DC} + 0.5V_{p-p}$
 $C_{OUT} = \text{tantal } 1.0\mu F$

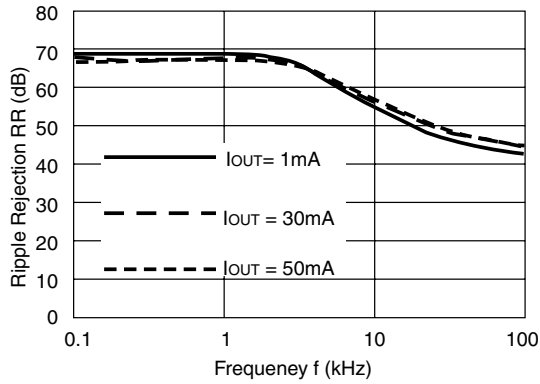

R1111N401B

$V_{IN} = 5.0V_{DC} + 0.5V_{p-p}$
 $C_{OUT} = \text{tantal } 2.2\mu F$

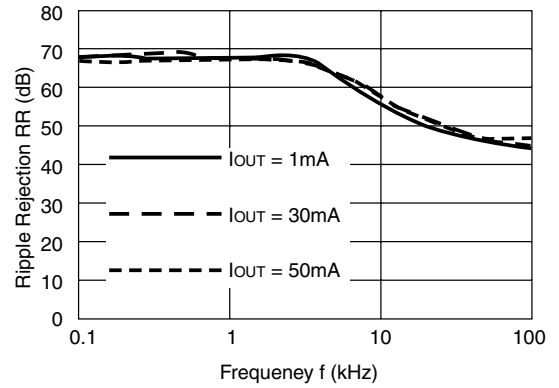

9) Ripple Rejection vs. Input Voltage (DC bias)

R1111N301B

$I_{OUT} = 1mA$
 $C_{OUT} = 2.2\mu F$

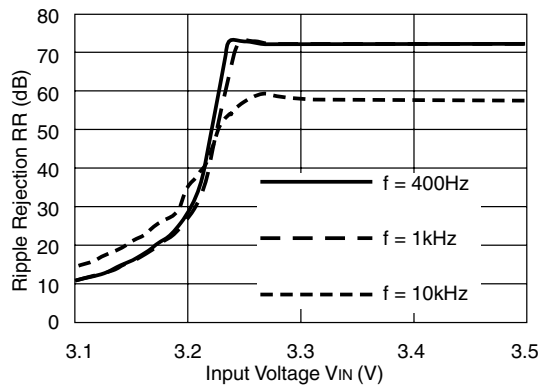

R1111N301B

$I_{OUT} = 10mA$
 $C_{OUT} = 2.2\mu F$

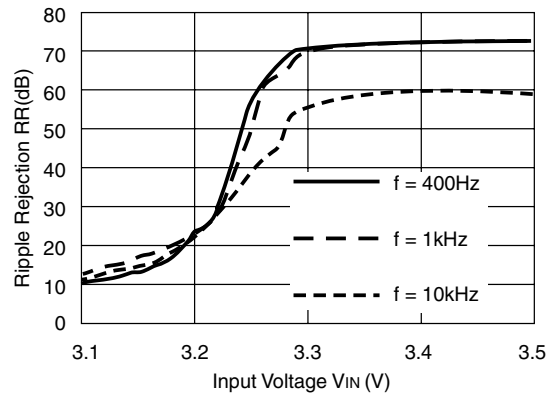

R1111N301B

$I_{OUT} = 50mA$
 $C_{OUT} = 2.2\mu F$

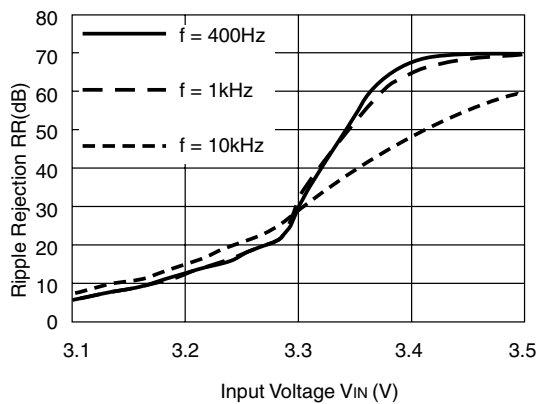

10) Line Transient Response

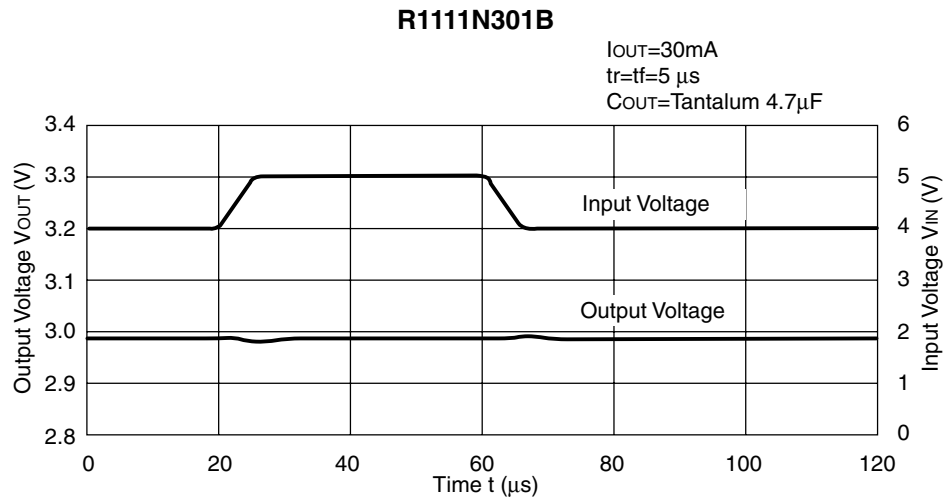
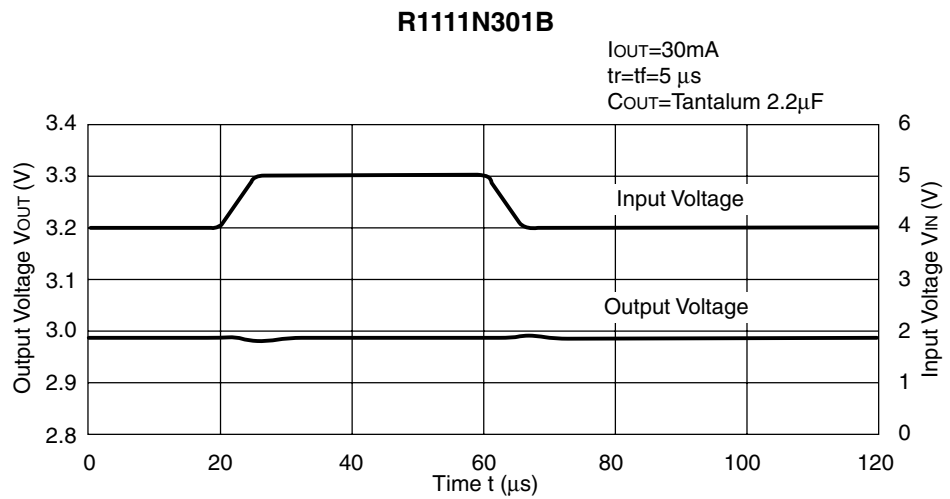
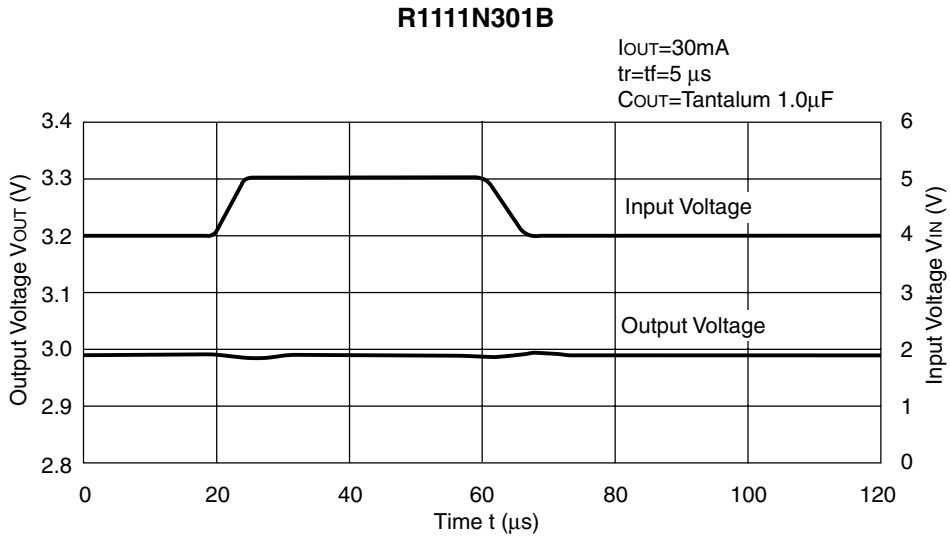

11) Load Transient Response

R1111N301B

$V_{IN}=4V$
 $C_{IN}=\text{Tantalum } 1\mu F$
 $C_{OUT}=\text{Tantalum } 1.0\mu F$

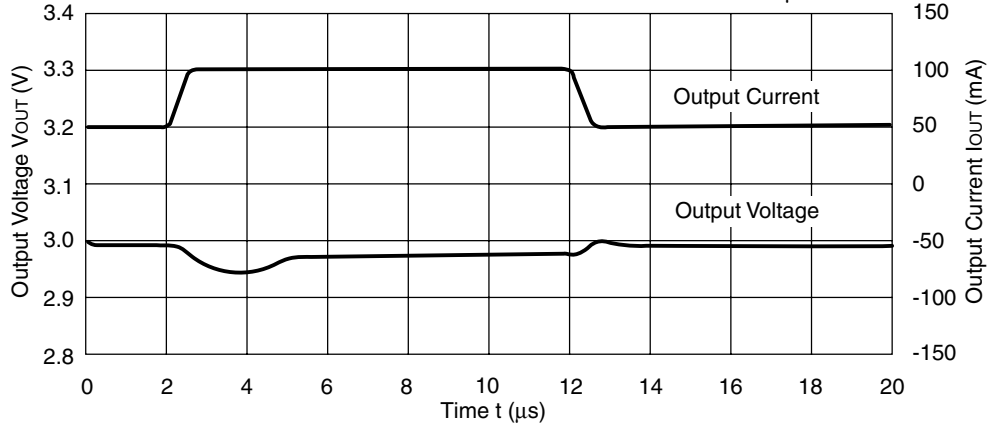

R1111N301B

$V_{IN}=4V$
 $C_{IN}=\text{Tantalum } 1\mu F$
 $C_{OUT}=\text{Tantalum } 2.2\mu F$

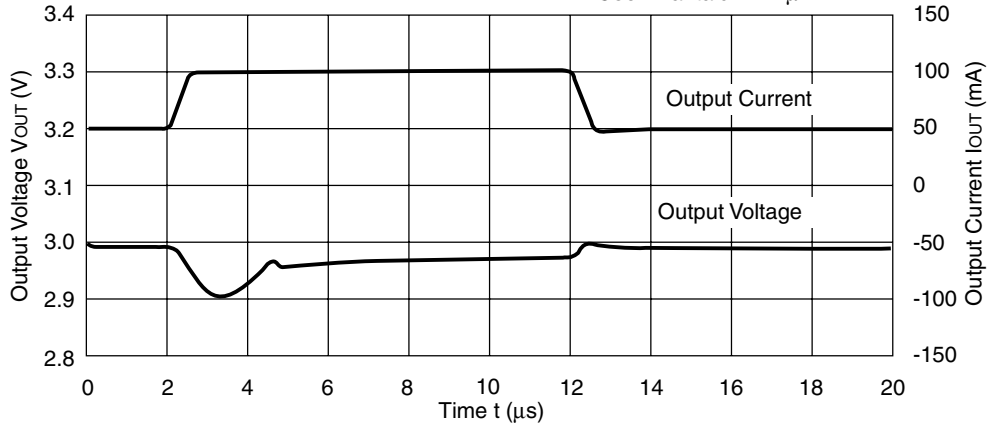

R1111N301B

$V_{IN}=4V$
 $C_{IN}=\text{Tantalum } 1\mu F$
 $C_{OUT}=\text{Tantalum } 4.7\mu F$

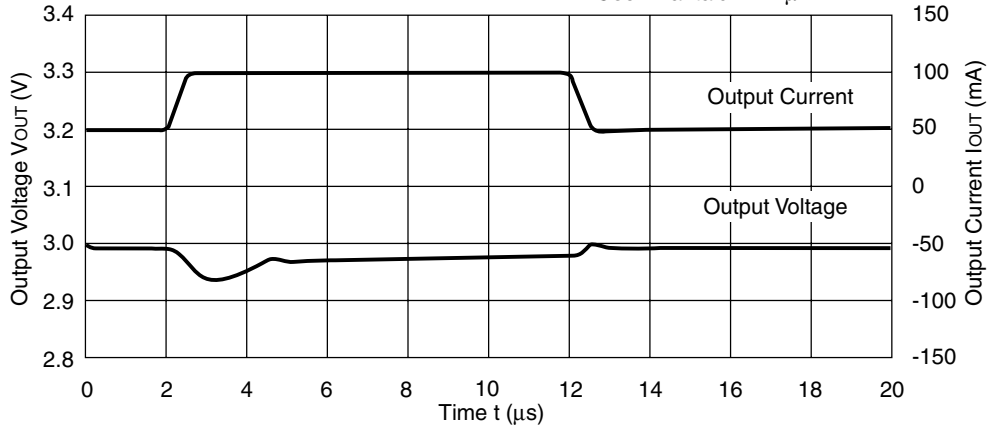

TECHNICAL NOTES

When using these ICs, consider the following points:

In these ICs, phase compensation is made for securing stable operation even if the load current is varied. For this purpose, be sure to use a capacitor C_{OUT} with good frequency characteristics and ESR (Equivalent Series Resistance) of which is in the range described as follows:

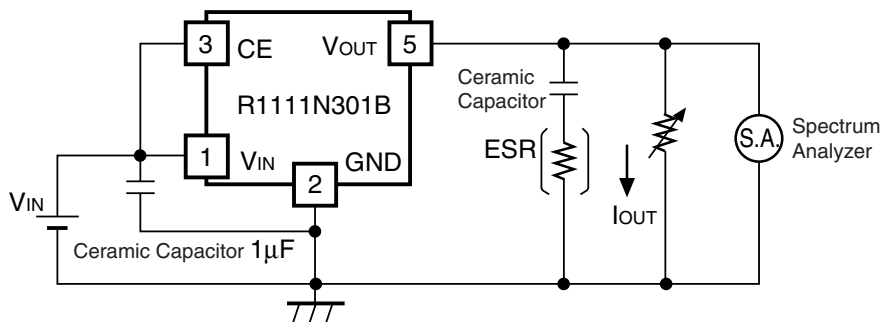

Measuring Circuit for white noise;R1111N301B

The relationship between I_{OUT} (output current) and ESR of output capacitor is shown in the graphs below. The conditions when the white noise level is under $40\mu V$ (Avg.) are indicated by the hatched area in the graph.

(note: When the additional ceramic capacitors are connected to the output pin with output capacitor for phase compensation, the operation might be unstable. Because of this, test these ICs with as the same external components as the ones to be used on the PCB.)

<measuring conditions>

- (1) $V_{IN}=4V$
- (2) Frequency band: 10Hz to 1MHz
- (3) Temperature: 25°C

R1111N301B

Ceramic 1.0µF

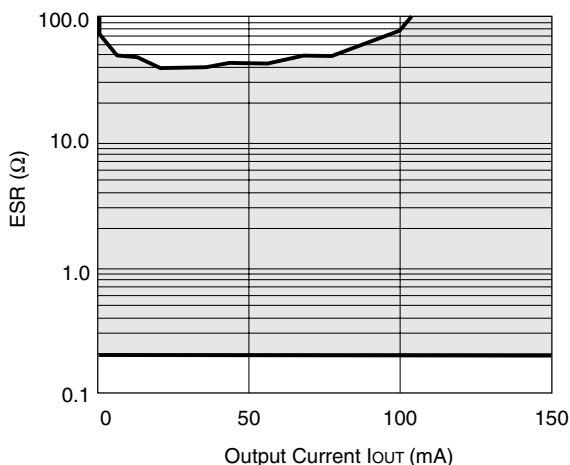

R1111N301B

Ceramic 2.2µF

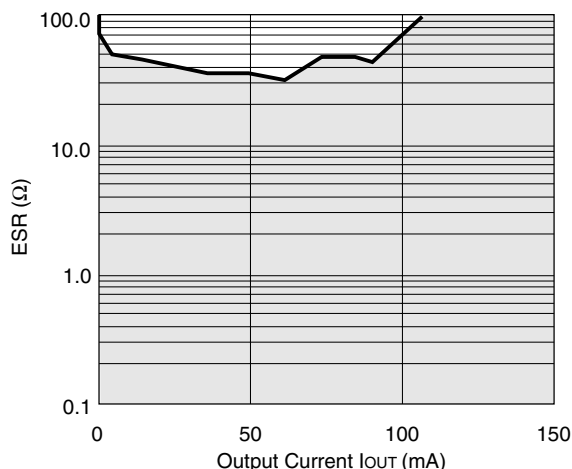

- Make V_{DD} and GND lines sufficient. If their impedance is high, noise pick up or incorrect operation may result.
- Connect the capacitor with a capacitance of $1\mu\text{F}$ or more between V_{DD} and GND as close as possible.
- Set external components, especially the output capacitor, as close as possible to the ICs and make wiring as short as possible.

TYPICAL APPLICATION

