

CEM9939

PRELIMINARY

Dual Enhancement Mode Field Effect Transistor (N and P Channel)

5

FEATURES

- 30V , 3.5A , $R_{DS(ON)}=50m\Omega$ @ $V_{GS}=10V$.
 $R_{DS(ON)}=80m\Omega$ @ $V_{GS}=4.5V$.
- -30V , -3.5A , $R_{DS(ON)}=100m\Omega$ @ $V_{GS}=-10V$.
 $R_{DS(ON)}=160m\Omega$ @ $V_{GS}=-4.5V$.
- Super high dense cell design for extremely low $R_{DS(ON)}$.
- High power and current handling capability.
- Surface Mount Package.

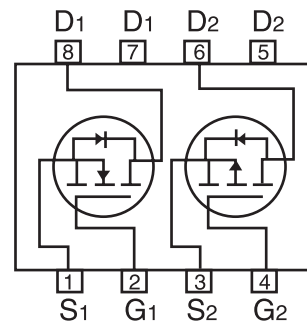
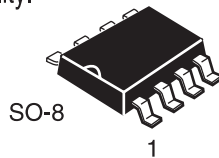

ABSOLUTE MAXIMUM RATINGS ($T_A=25^{\circ}C$ unless otherwise noted)

Parameter	Symbol	N-Channel	P-Channel	Unit
Drain-Source Voltage	VDS	30	-30	V
Gate-Source Voltage	VGS	± 20	± 20	V
Drain Current-Continuous ^a @ $T_J=125^{\circ}C$ -Pulsed ^b	ID	± 3.5	± 3.5	A
	IDM	± 14.0	± 14.0	A
Drain-Source Diode Forward Current ^a	IS	1.7	-1.7	A
Maximum Power Dissipation ^a	PD	2.0		W
Operating Junction and Storage Temperature Range	TJ, TSTG	-55 to 150		$^{\circ}C$

THERMAL CHARACTERISTICS

Thermal Resistance, Junction-to-Ambient ^a	$R_{\theta JA}$	62.5	$^{\circ}C/W$
--	-----------------	------	---------------

CEM9939

N-Channel ELECTRICAL CHARACTERISTICS (TA=25 °C unless otherwise noted)

5

Parameter	Symbol	Condition	Min	Typ ^c	Max	Unit
OFF CHARACTERISTICS						
Drain-Source Breakdown Voltage	BV _{DSS}	V _{GS} =0V, I _D =250μA	30			V
Zero Gate Voltage Drain Current	I _{DSS}	V _{DS} =24V, V _{GS} =0V			1	μA
Gate-Body Leakage	I _{GSS}	V _{GS} =±20V, V _{DS} =0V			±100	nA
ON CHARACTERISTICS^b						
Gate Threshold Voltage	V _{GS(th)}	V _{DS} =V _{GS} , I _D =250μA	1	1.5	3	V
Drain-Source On-State Resistance	R _{DS(ON)}	V _{GS} =10V, I _D =3.5A		25	50	mΩ
		V _{GS} =4.5V, I _D =2.5A		35	80	mΩ
On-State Drain Current	I _{D(ON)}	V _{DS} =5V, V _{GS} =10V	14			A
Forward Transconductance	g _{FS}	V _{DS} =15V, I _D =3.5A	3	7		S
DYNAMIC CHARACTERISTICS^c						
Input Capacitance	C _{ISS}	V _{DS} =15V, V _{GS} =0V f=1.0MHz		500	650	pF
Output Capacitance	C _{OSS}			267	350	pF
Reverse Transfer Capacitance	C _{RSS}			93	120	pF
SWITCHING CHARACTERISTICS^c						
Turn-On Delay Time	t _{D(ON)}	V _{DD} =15V, I _D =1A, R _L =15Ω V _{GEN} =10V, R _{GEN} =6Ω			30	ns
Rise Time	t _r				40	ns
Turn-Off Delay Time	t _{D(OFF)}				50	ns
Fall Time	t _f				50	ns
Total Gate Charge	Q _g	V _{DS} =10V, I _D =3.5A, V _{GS} =10V		13	35	nC
Gate-Source Charge	Q _{gs}			2		nC
Gate-Drain Charge	Q _{gd}			5		nC

CEM9939

P-Channel ELECTRICAL CHARACTERISTICS (TA=25 °C unless otherwise noted)

5

Parameter	Symbol	Condition	Min	Typ ^c	Max	Unit
OFF CHARACTERISTICS						
Drain-Source Breakdown Voltage	BV _{DSS}	V _{GS} =0V, I _D =250μA	-30			V
Zero Gate Voltage Drain Current	I _{DSS}	V _{DS} =-24V, V _{GS} =0V			-1	μA
Gate-Body Leakage	I _{GSS}	V _{GS} =±20V, V _{DS} =0V			±100	nA
ON CHARACTERISTICS^b						
Gate Threshold Voltage	V _{GS(th)}	V _{DS} =V _{GS} , I _D = -250μA	-1	-1.4	-3	V
Drain-Source On-State Resistance	R _{DS(ON)}	V _{GS} =-10V, I _D = -3.5A		67	100	mΩ
		V _{GS} =-4.5V, I _D =-2A		108	160	mΩ
On-State Drain Current	I _{D(ON)}	V _{DS} = -5V, V _{GS} = -10V	-14			A
Forward Transconductance	g _{FS}	V _{DS} = -15V, I _D = -3.5A	3	5		S
DYNAMIC CHARACTERISTICS^c						
Input Capacitance	C _{ISS}	V _{DS} =-15V, V _{GS} = 0V f = 1.0MHz		500	650	pF
Output Capacitance	C _{OSS}			267	350	pF
Reverse Transfer Capacitance	C _{RSS}			93	120	pF
SWITCHING CHARACTERISTICS^c						
Turn-On Delay Time	t _{D(ON)}	V _{DD} = -15V, I _D = -1A, R _L = 15Ω V _{GEN} = -10V, R _{GEN} = 6Ω			30	ns
Rise Time	t _r				40	ns
Turn-Off Delay Time	t _{D(OFF)}				50	ns
Fall Time	t _f				50	ns
Total Gate Charge	Q _g	V _{DS} = -10V, I _D = -3.5A, V _{GS} = -10V		13	35	nC
Gate-Source Charge	Q _{gs}			3		nC
Gate-Drain Charge	Q _{gd}			4		nC

CEM9939

ELECTRICAL CHARACTERISTICS ($T_A=25^\circ\text{C}$ unless otherwise noted)

5

Parameter	Symbol	Condition	Min	Typ ^c	Max	Unit
DRAIN-SOURCE DIODE CHARACTERISTICS^b						
Diode Forward Voltage	V_{SD}	$V_{GS} = 0V, I_s = 1.7A$ N-Ch		0.77	1.2	V
		$V_{GS} = 0V, I_s = -1.7A$ P-Ch		-0.80	-1.2	

Notes

- Surface Mounted on FR4 Board, $t \leq 10\text{sec}$.
- Pulse Test: Pulse Width $\leq 300 \mu\text{s}$, Duty Cycle $\leq 2\%$.
- Guaranteed by design, not subject to production testing.

N-Channel

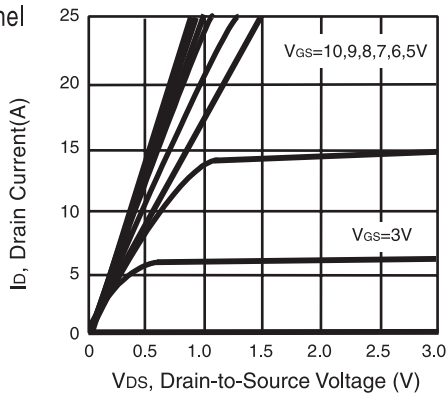

Figure 1. Output Characteristics

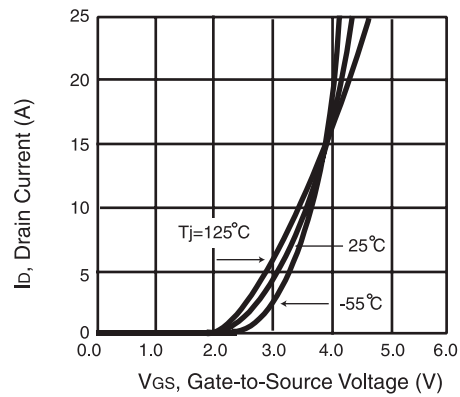

Figure 2. Transfer Characteristics

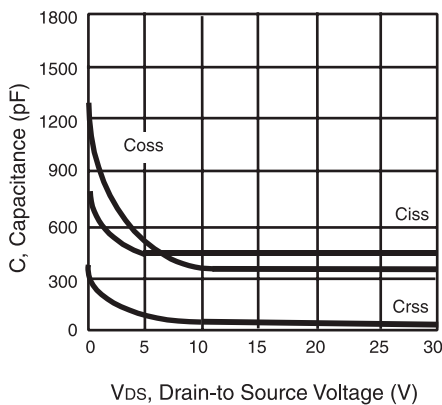

Figure 3. Capacitance

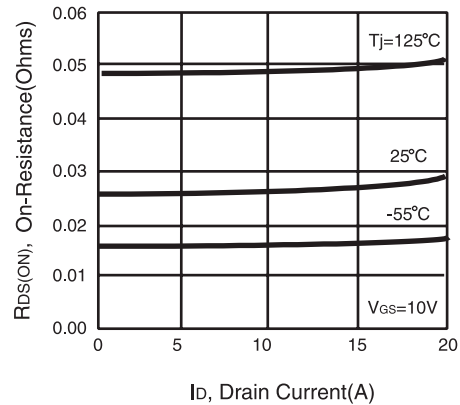

Figure 4. On-Resistance Variation with Drain Current and Temperature

CEM9939

5

N-Channel

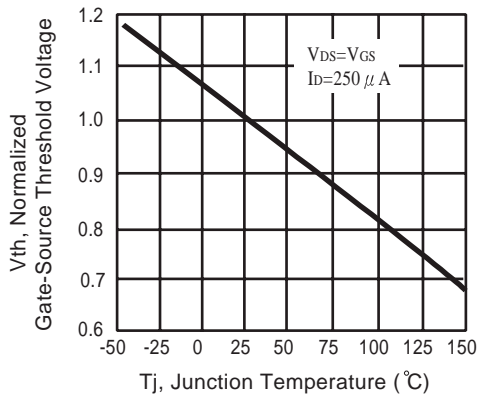

Figure 5. Gate Threshold Variation with Temperature

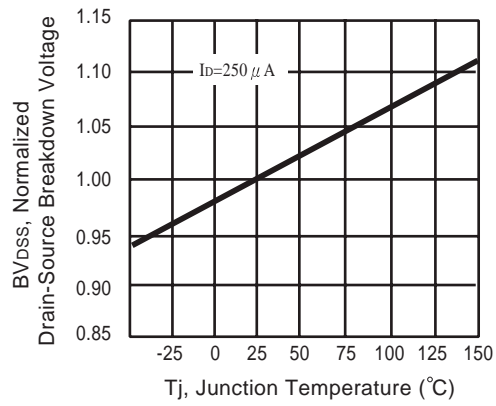

Figure 6. Breakdown Voltage Variation with Temperature

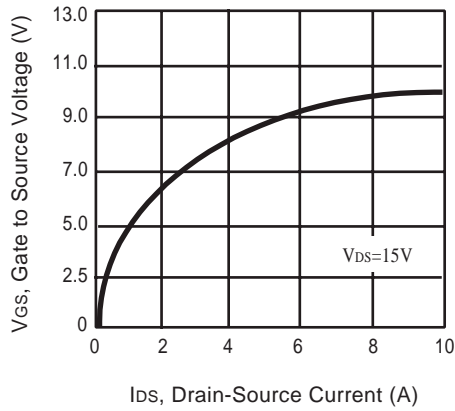

Figure 7. Transconductance Variation with Temperature

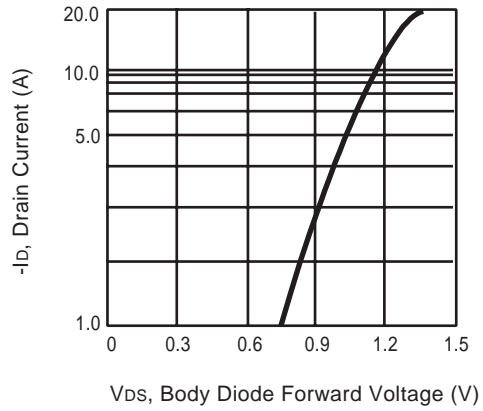

Figure 8. Body Diode Forward Voltage Variation with Source Current

CEM9939

5

P-Channel

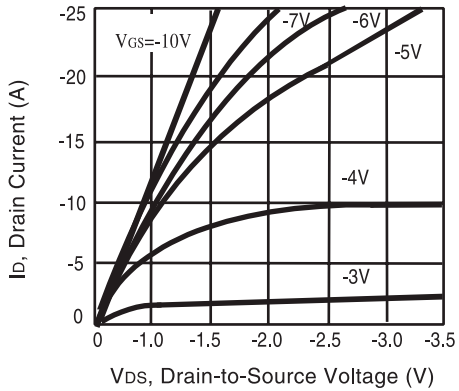

Figure 1. Output Characteristics

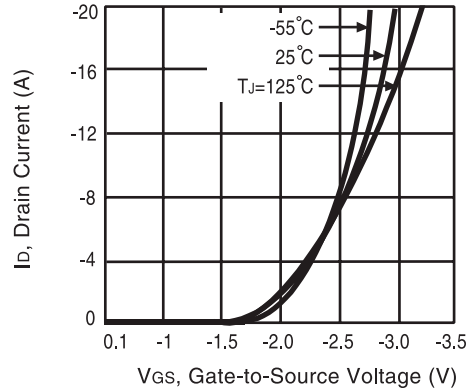

Figure 2. Transfer Characteristics

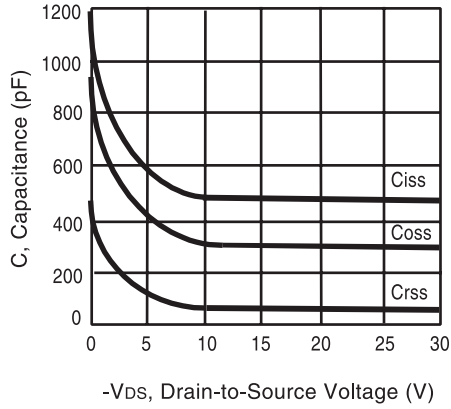

Figure 3. Capacitance

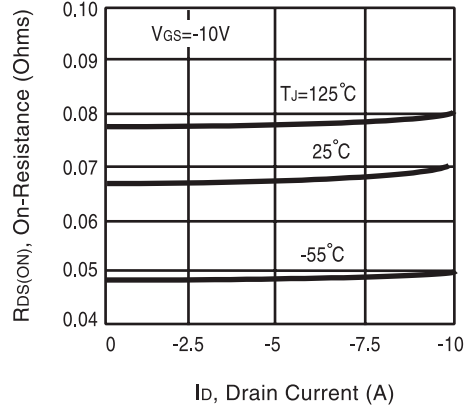

Figure 4. On-Resistance Variation with Drain Current and Temperature

CEM9939

5

P-Channel

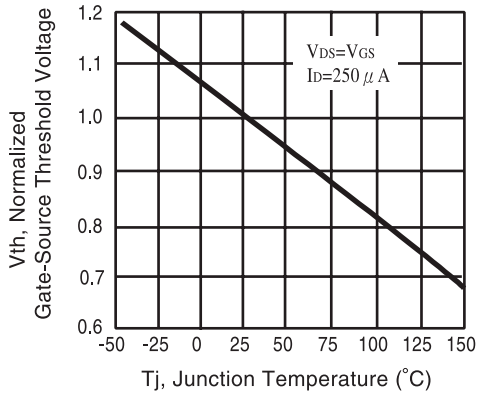

Figure 5. Gate Threshold Variation with Temperature

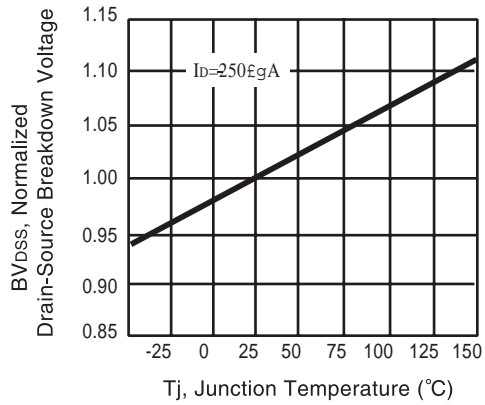

Figure 6. Breakdown Voltage Variation with Temperature

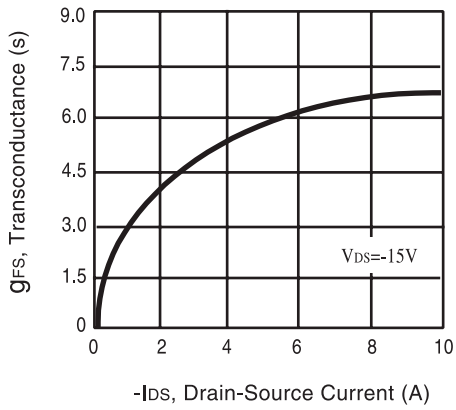

Figure 7. Transconductance Variation with Temperature

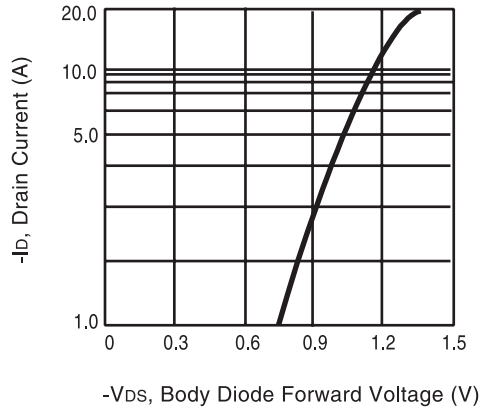

Figure 8. Body Diode Forward Voltage Variation with Source Current

CEM9939

5

N-Channel

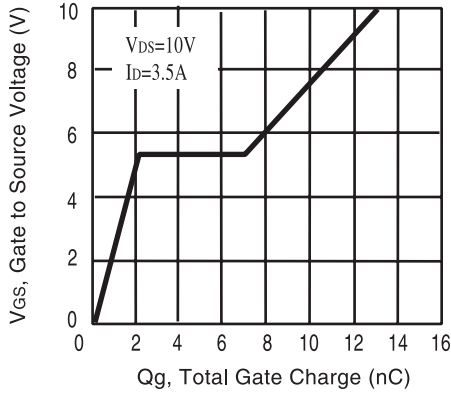

Figure 9. Gate Charge

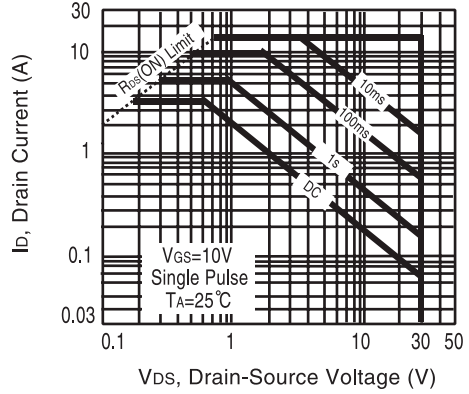

Figure 10. Maximum Safe Operating Area

P-Channel

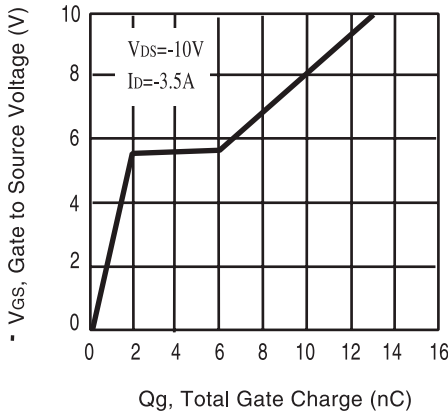

Figure 9. Gate Charge

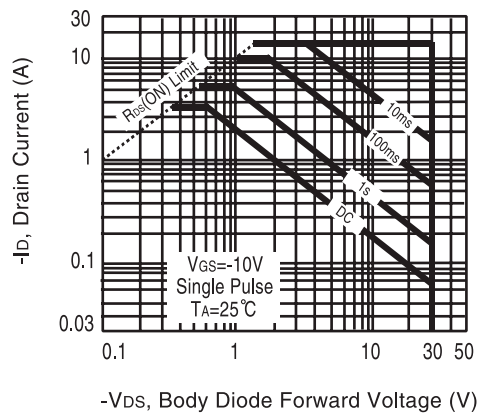

Figure 10. Maximum Safe Operating Area

CEM9939

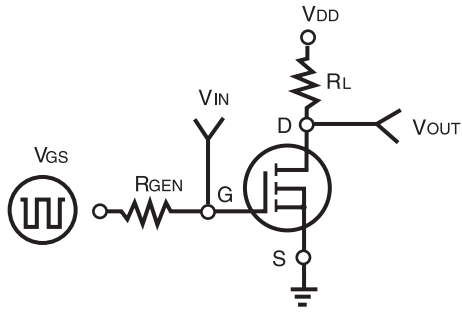

Figure 11. Switching Test Circuit

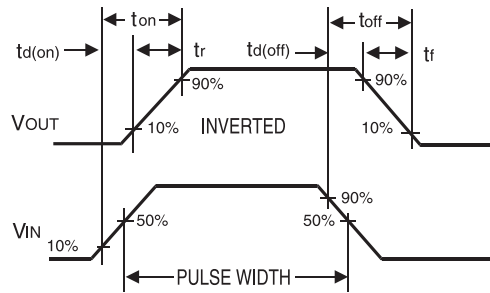

Figure 12. Switching Waveforms

5

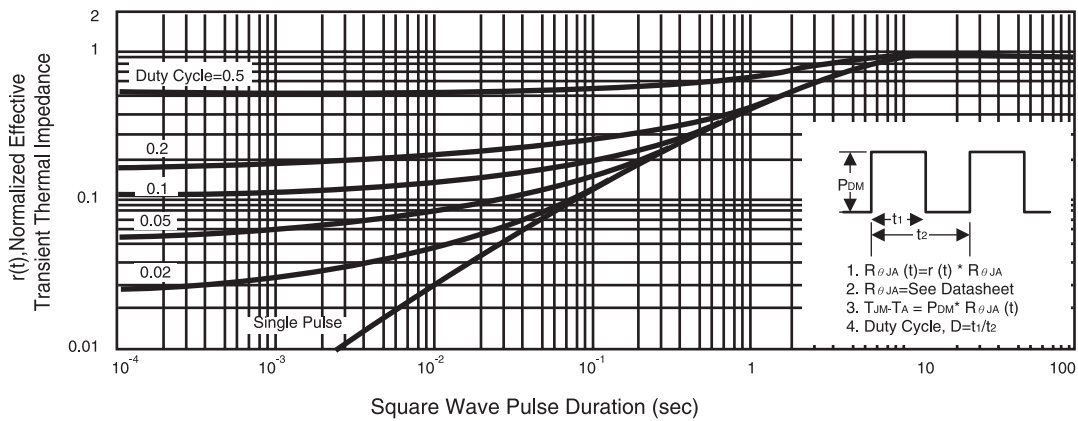

Figure 13. Normalized Thermal Transient Impedance Curve