

MOTOROLA
SEMICONDUCTOR
 TECHNICAL DATA

Photo Detectors
Transistor Output

MRD300
MRD310*

*Motorola Preferred Device

PHOTO DETECTORS
TRANSISTOR OUTPUT
NPN SILICON

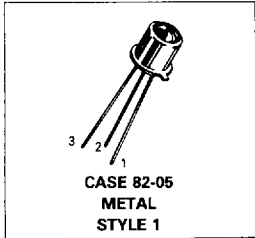

The MRD300 and MRD310 are designed for applications requiring radiation sensitivity and stable characteristics.

Features:

- Popular TO-18 Type Package for Easy Handling and Mounting
- Sensitive Throughout Visible and Near Infrared Spectral Range for Wider Application
- Minimum Light Current 4 mA at H = 5 mW/cm₂ (MRD300)
- External Base for Added Control
- Annular Passivated Structure for Stability and Reliability

Applications:

- Industrial Processing and Control
- Shaft or Position Readers
- Optical Switching
- Remote Control
- Light Modulators
- Punched Card Readers
- Logic Circuits
- Counters

MAXIMUM RATINGS (T_A = 25°C unless otherwise noted)

Rating	Symbol	Value	Unit
Collector-Emitter Voltage	V _{CEO}	50	Volts
Emitter-Collector Voltage	V _{ECO}	7	Volts
Collector-Base Voltage	V _{CBO}	80	Volts
Total Device Dissipation @ T _A = 25°C Derate above 25°C	P _D	250 2.27	mW mW/°C
Operating Temperature Range	T _A	-55 to +125	°C
Storage Temperature Range	T _{stg}	-65 to +150	°C

STATIC ELECTRICAL CHARACTERISTICS (T_A = 25°C unless otherwise noted)

Characteristic	Symbol	Min	Typ	Max	Unit
Collector Dark Current (V _{CE} = 20 V, H ≈ 0) T _A = 25°C T _A = 100°C	I _{CEO}	— —	5 4	25 —	nA μA
Collector-Base Breakdown Voltage (I _C = 100 μA)	V _{(BR)CBO}	80	120	—	Volts
Collector-Emitter Breakdown Voltage (I _C = 100 μA)	V _{(BR)CEO}	50	85	—	Volts
Emitter-Collector Breakdown Voltage (I _E = 100 μA)	V _{(BR)ECO}	7	8.5	—	Volts

OPTICAL CHARACTERISTICS (T_A = 25°C unless otherwise noted)

Light Current (V _{CC} = 20 V, R _L = 10 Ohms) Note 1	MRD300 MRD310	I _L	4 1	7 3.5	— —	mA
Light Current (V _{CC} = 20 V, R _L = 100 Ohms) Note 2	MRD300 MRD310	I _L	— —	2.5 0.8	— —	mA
Photo Current Rise Time (Note 3) (R _L = 100 Ohms, I _L = 1 mA peak)		t _r	—	2	2.5	μs
Photo Current Fall Time (Note 3) (R _L = 100 Ohms, I _L = 1 mA peak)		t _f	—	2.5	4	μs

NOTES 1 Radiation flux density (H) equal to 5 mW/cm² emitted from a tungsten source at a color temperature of 2870 K
 2 Radiation flux density (H) equal to 0.5 mW/cm² (pulsed) from a GaAs (gallium-arsenide) source at λ = 940 nm
 3 For unsaturated response time measurements, radiation is provided by pulsed GaAs (gallium-arsenide) light-emitting diode (λ ≈ 940 nm) with a pulse width equal to or greater than 10 microseconds (see Figure 2) I_L = 1 mA peak

TYPICAL CHARACTERISTICS

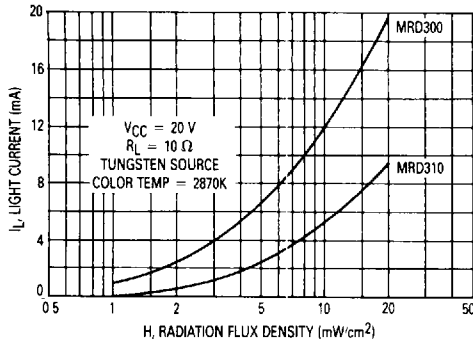

Figure 1. Light Current versus Irradiance

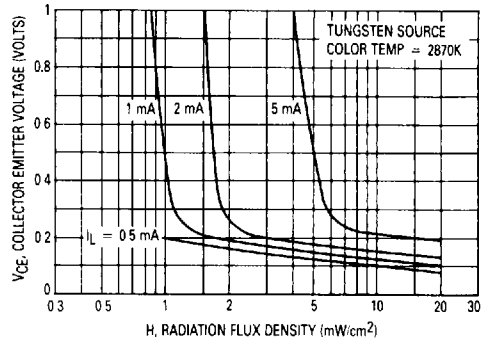

Figure 2. Collector-Emitter Saturation Characteristic

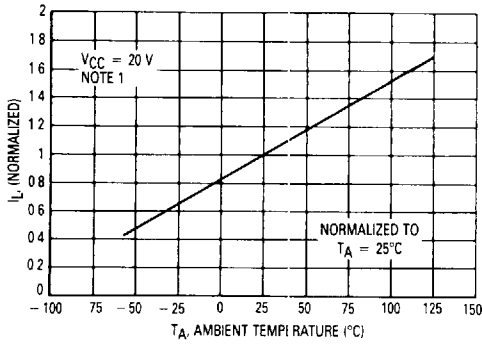

Figure 3. Normalized Light Current versus Temperature

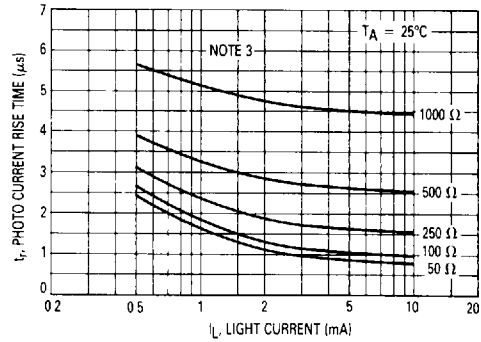

Figure 4. Rise Time versus Light Current

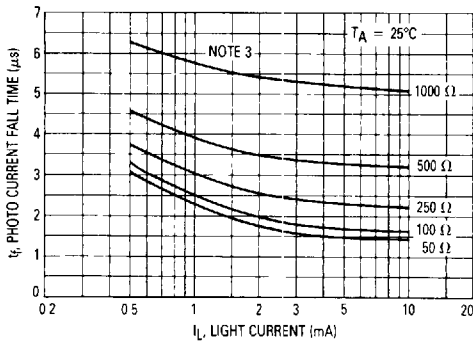

Figure 5. Fall Time versus Light Current

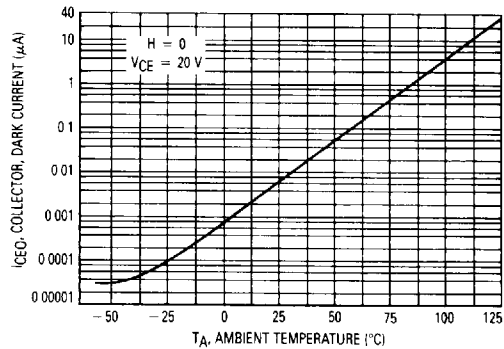

Figure 6. Dark Current versus Temperature

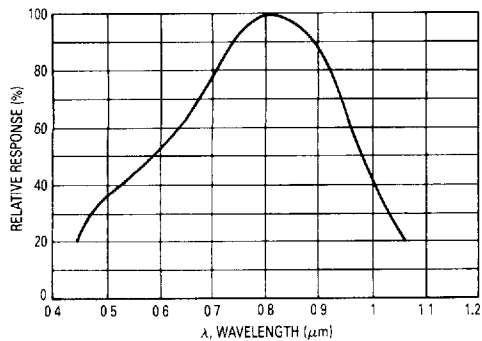

Figure 7. Constant Energy Spectral Response

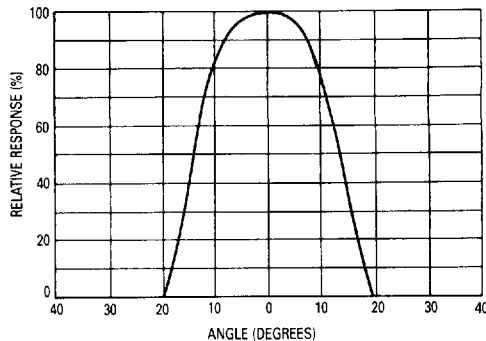

Figure 8. Angular Response

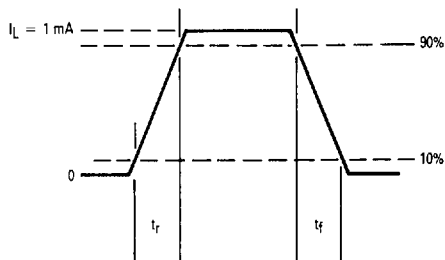
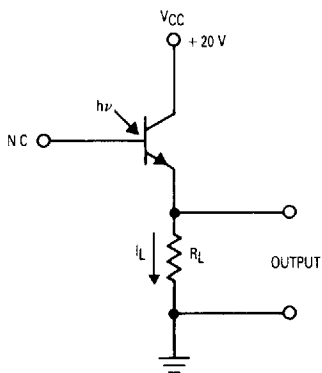

Figure 9. Pulse Response Test Circuit and Waveform