

## GaAs MMIC SP4T SWITCH NON-REFLECTIVE DC TO 6.0 GHz

FEBRUARY 2001

v02.0101

### Features

- BROADBAND PERFORMANCE: DC to 6GHz
- SINGLE POSITIVE SUPPLY: Vdd = +5V
- INTEGRATED 2:4 TTL DECODER
- CERAMIC SMT PACKAGE

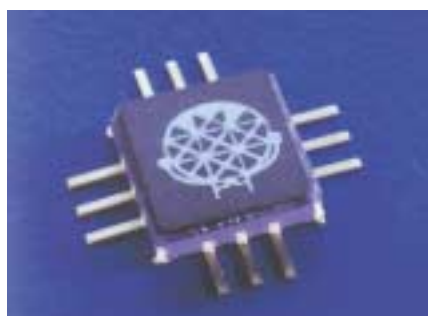

### General Description

The HMC222C12 is a broadband non-reflective SP4T switch in a ceramic surface mount package. This SP4T switch covers RF telecom/datacom bands from DC - 6 GHz. The switch offers a single positive bias and true TTL/CMOS compatibility. A 2:4 decoder is integrated on the switch requiring only 2 control lines and a +5V bias to select each path. An input IP3 of +40 dBm helps maintain the best possible dynamic range in receiver & test instrument applications. The integrated 2:4 TTL/CMOS decoder replaces 8 control lines normal required by GaAs SP4T switches.

7

SWITCHES

SP4T

SMT



### Guaranteed Performance

For TTL Control and Vdd = +5V in a 50 Ohm system, -40 to +85 deg C

Parameter	Frequency	Min.	Typ.	Max.	Units
Insertion Loss	DC - 1.0 GHz		1.9	2.2	dB
	DC - 2.0 GHz		2.1	2.5	
	DC - 6.0 GHz		2.4	2.8	
Isolation	DC - 1.0 GHz	42	52		dB
	DC - 2.0 GHz	37	43		
	DC - 6.0 GHz	22	27		
Return Loss	"On State"	DC - 2.0 GHz	15	18	dB
		DC - 6.0 GHz	9	12	
Return Loss	RF1-4 "Off State"	0.7 - 6.0 GHz	6.5	>10	dB
		2.0 - 6.0 GHz	11	14	
Input Power for 1dB Compression	0.5 - 6.0 GHz	17	20		dBm
Input Third Order Intercept (Two-Tone Input Power = +7dBm Each Tone)	0.5 - 6.0 GHz		43		dBm
Switching Characteristics	0.5 - 6.0 GHz				
tRISE, tFALL (10/90% RF)			35		ns
tON, tOFF (50% CTL to 10/90% RF)			150		ns

## HMC222C12 SP4T SWITCH NON-REFLECTIVE DC TO 6.0 GHz

v02.0101

FEBRUARY 2001

### Insertion Loss

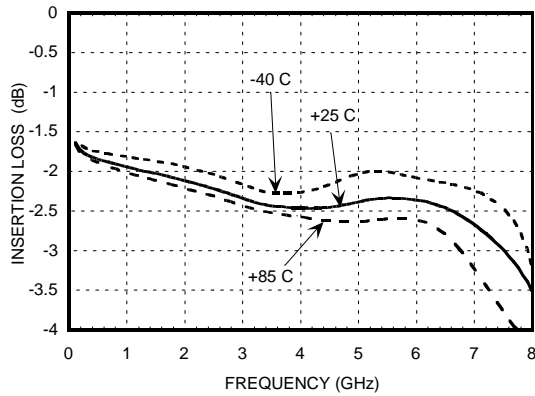

### Isolation

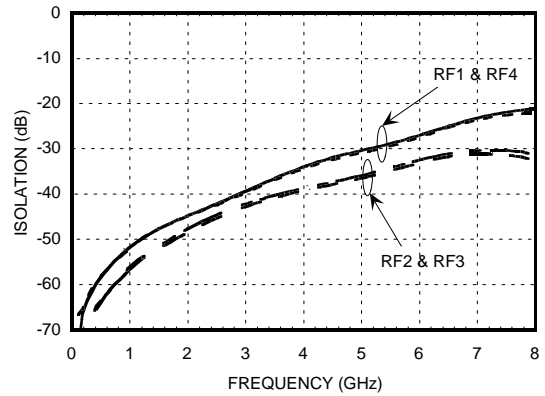

### Return Loss

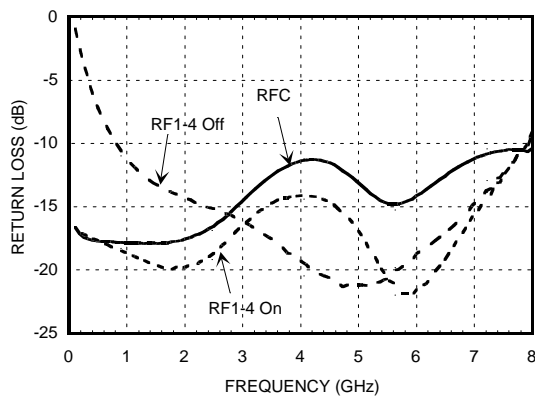

### 0.1 and 1 dB Input Compression Point

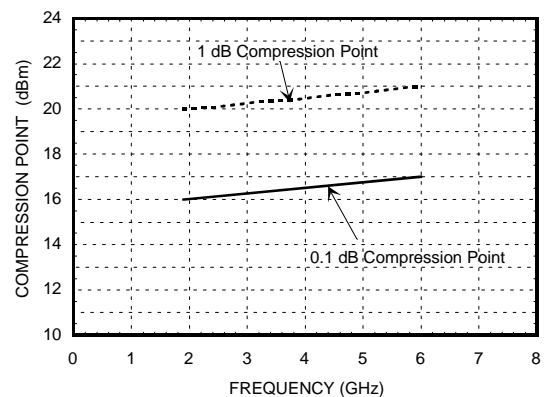

## HMC222C12 SP4T SWITCH NON-REFLECTIVE DC TO 6.0 GHz

FEBRUARY 2001

v02.0101

### Functional Diagram

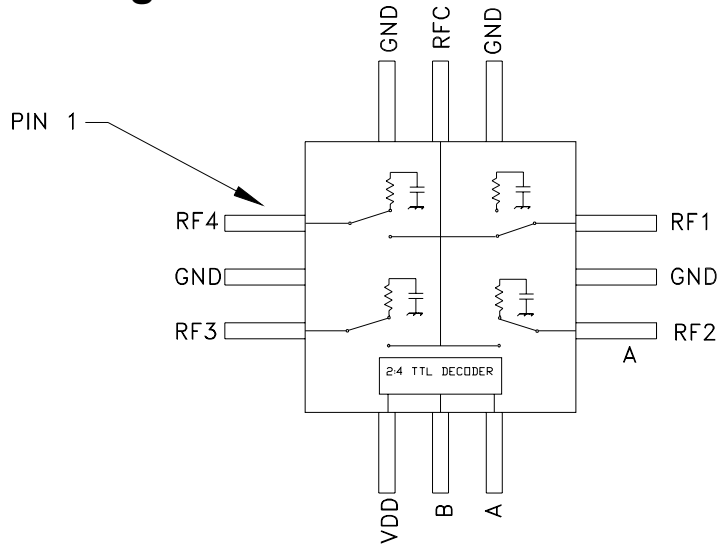

7  
SMT SP4T SWITCHES

### Absolute Maximum Ratings

Bias Voltage Range (Port Vdd)	+7.0 Vdc
Control Voltage Range (A & B)	-0.5V to Vdd + 1Vdc
Storage Temperature	-65 to +150 deg C
Operating Temperature	-40 to +85 deg C
Maximum Input Power Vdd = +5 Vdc	+16dBm (0.05-0.5GHz) +22dBm (0.5-6.0GHz)

**NOTE:**

- 1) DC blocking capacitors are required at ports RFC and RF1, 2, 3, 4.

### Truth Table

Control Input		Signal Path State
A	B	RFCOM to:
Low	Low	RF1
High	Low	RF2
Low	High	RF3
High	High	RF4

### Bias Voltage & Current

Vdd Range = +5.0 Vdc ± 10%		
Vdd (Vdc)	Idd (Typ.) (mA)	Idd (Max.) (mA)
+5.0	3.0	5.0

### TTL/CMOS Control Voltages

State	Bias Condition
Low	0 to +0.8Vdc @5uA Typ.
High	+2.0 to +5.0 Vdc @ 50uA Typ.

## HMC222C12 SP4T SWITCH NON-REFLECTIVE DC TO 6.0 GHz

v02.0101

FEBRUARY 2001

### Outline Drawing

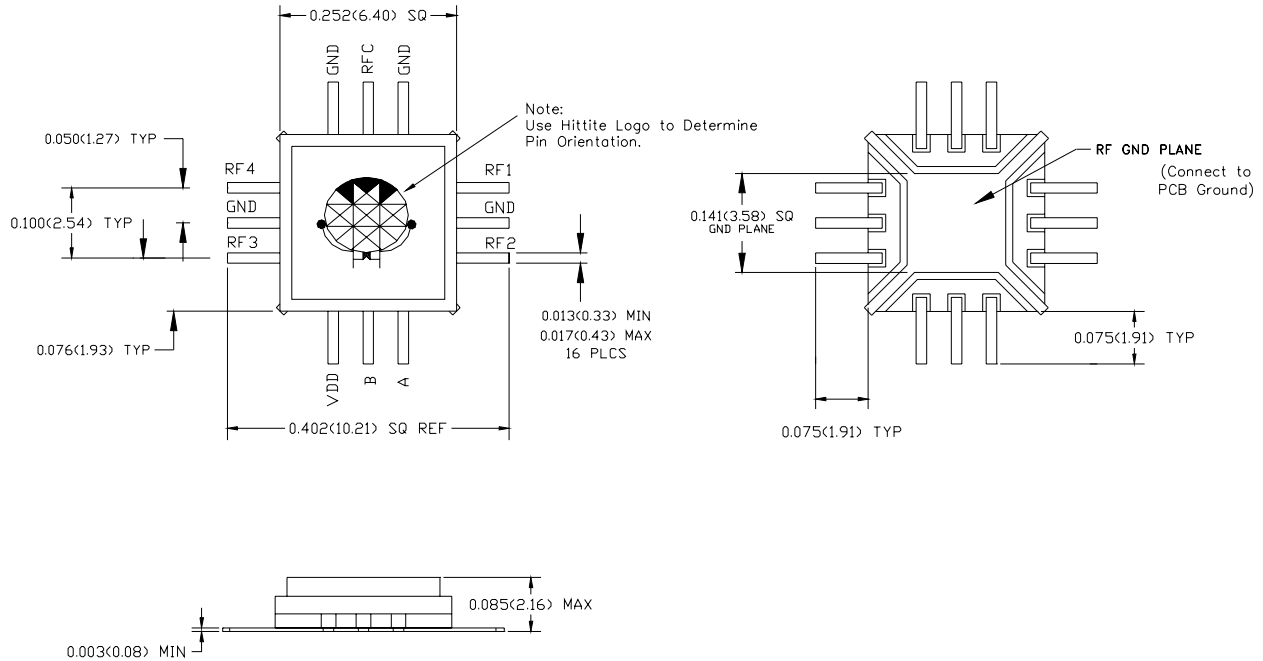

1. MATERIAL:  
A) PACKAGE BODY & COVER : WHITE ALUMINA (92%)  
B) LEADS: KOVAR (TM) OR ASTM F-15 (ALLOY 42) EQUIVALENT
2. PLATING (LEADS): ELECTROLYTIC GOLD 25 MICRONS. MINIMUM, OVER ELECTROLYTIC NICKEL 100 TO 250 MICRONS
3. DIMENSIONS ARE IN INCHES (MILLIMETERS), UNLESS OTHERWISE SPECIFIED TOL. ARE ±0.005.
4. ALL UNLABELED LEADS ARE GROUND.

## HMC222C12 SP4T SWITCH NON-REFLECTIVE DC TO 6.0 GHz

FEBRUARY 2001

v02.0101

### ***Eval Board Layout (Top View)***

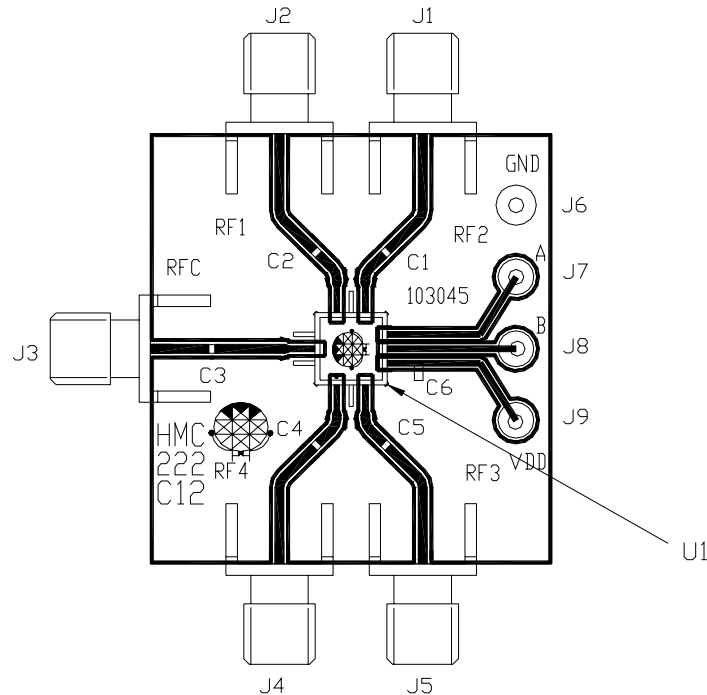

The circuit board used in the final application should be generated with proper RF circuit design techniques. Signal lines at the RF port should have 50 ohm impedance and the package ground leads and exposed ground paddle should be connected directly to the ground plane similar to that shown above. The evaluation circuit board shown above is available from Hittite Microwave Corporation upon request.

#### ***List of Material***

Item	Description
J1 - J5	PC Mount SMA Connector
J6 - J9	DC Pin
C1 - C5	100pF Capacitor, 0402 Pkg.
C6	0.01 uF Capacitor, 0603 Pkg.
U1	HMC222C12 SP4T Switch
PCB*	103045 Evaluation PCB 1.4 x 1.5
<i>*Circuit Board Material: Rogers 4350</i>	

**HMC222C12 SP4T SWITCH NON-REFLECTIVE DC TO 6.0 GHz**

v02.0101

FEBRUARY 2001

NOTES: