

## Silicon Power Transistors

The MJL21193 and MJL21194 utilize Perforated Emitter technology and are specifically designed for high power audio output, disk head positioners and linear applications.

- Total Harmonic Distortion Characterized
- High DC Current Gain –  $h_{FE} = 25$  Min @  $I_C = 8$  Adc
- Excellent Gain Linearity
- High SOA: 2.25 A, 80 V, 1 Second

**PNP**  
**MJL21193\***  
**NPN**  
**MJL21194\***

\*Motorola Preferred Device

**16 AMPERE**  
**COMPLEMENTARY**  
**SILICON POWER**  
**TRANSISTORS**  
**250 VOLTS**  
**200 WATTS**

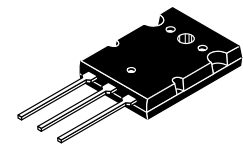

**CASE 340G-02**  
**TO-3PBL**

### MAXIMUM RATINGS

Rating	Symbol	Value	Unit
Collector–Emitter Voltage	$V_{CEO}$	250	Vdc
Collector–Base Voltage	$V_{CBO}$	400	Vdc
Emitter–Base Voltage	$V_{EBO}$	5	Vdc
Collector–Emitter Voltage – 1.5 V	$V_{CEX}$	400	Vdc
Collector Current — Continuous Peak (1)	$I_C$	16 30	Adc
Base Current – Continuous	$I_B$	5	Adc
Total Power Dissipation @ $T_C = 25^\circ\text{C}$ Derate Above $25^\circ\text{C}$	$P_D$	200 1.43	Watts W/ $^\circ\text{C}$
Operating and Storage Junction Temperature Range	$T_J, T_{stg}$	– 65 to +150	$^\circ\text{C}$

### THERMAL CHARACTERISTICS

Characteristic	Symbol	Max	Unit
Thermal Resistance, Junction to Case	$R_{\theta JC}$	0.7	$^\circ\text{C/W}$

### ELECTRICAL CHARACTERISTICS ( $T_C = 25^\circ\text{C}$ unless otherwise noted)

Characteristic	Symbol	Min	Typical	Max	Unit
----------------	--------	-----	---------	-----	------

### OFF CHARACTERISTICS

Collector–Emitter Sustaining Voltage ( $I_C = 100$ mAdc, $I_B = 0$ )	$V_{CEO(sus)}$	250	—	—	Vdc
Collector Cutoff Current ( $V_{CE} = 200$ Vdc, $I_B = 0$ )	$I_{CEO}$	—	—	100	$\mu\text{Adc}$

(1) Pulse Test: Pulse Width = 5.0  $\mu\text{s}$ , Duty Cycle  $\leq 10\%$ .

(continued)

**Preferred** devices are Motorola recommended choices for future use and best overall value.

# MJL21193 MJL21194

## ELECTRICAL CHARACTERISTICS ( $T_C = 25^\circ\text{C}$ unless otherwise noted)

Characteristic	Symbol	Min	Typical	Max	Unit
<b>OFF CHARACTERISTICS</b>					
Emitter Cutoff Current ( $V_{CE} = 5\text{ Vdc}$ , $I_C = 0$ )	$I_{EBO}$	—	—	100	$\mu\text{Adc}$
Collector Cutoff Current ( $V_{CE} = 250\text{ Vdc}$ , $V_{BE(\text{off})} = 1.5\text{ Vdc}$ )	$I_{CEX}$	—	—	100	$\mu\text{Adc}$
<b>SECOND BREAKDOWN</b>					
Second Breakdown Collector Current with Base Forward Biased ( $V_{CE} = 50\text{ Vdc}$ , $t = 1\text{ s}$ (non-repetitive)) ( $V_{CE} = 80\text{ Vdc}$ , $t = 1\text{ s}$ (non-repetitive))	$I_{S/b}$	4.0 2.25	— —	— —	A <sub>dc</sub>
<b>ON CHARACTERISTICS</b>					
DC Current Gain ( $I_C = 8\text{ Adc}$ , $V_{CE} = 5\text{ Vdc}$ ) ( $I_C = 16\text{ Adc}$ , $I_B = 5\text{ Adc}$ )	$h_{FE}$	25 8	— —	75 —	
Base-Emitter On Voltage ( $I_C = 8\text{ Adc}$ , $V_{CE} = 5\text{ Vdc}$ )	$V_{BE(\text{on})}$	—	—	2.2	V <sub>dc</sub>
Collector-Emitter Saturation Voltage ( $I_C = 8\text{ Adc}$ , $I_B = 0.8\text{ Adc}$ ) ( $I_C = 16\text{ Adc}$ , $I_B = 3.2\text{ Adc}$ )	$V_{CE(\text{sat})}$	— —	— —	1.4 4	V <sub>dc</sub>
<b>DYNAMIC CHARACTERISTICS</b>					
Total Harmonic Distortion at the Output $V_{RMS} = 28.3\text{ V}$ , $f = 1\text{ kHz}$ , $P_{LOAD} = 100\text{ W}_{RMS}$ (Matched pair $h_{FE} = 50 @ 5\text{ A}/5\text{ V}$ )	$T_{HD}$	— —	0.8 0.08	— —	%
Current Gain Bandwidth Product ( $I_C = 1\text{ Adc}$ , $V_{CE} = 10\text{ Vdc}$ , $f_{\text{test}} = 1\text{ MHz}$ )	$f_T$	4	—	—	MHz
Output Capacitance ( $V_{CB} = 10\text{ Vdc}$ , $I_E = 0$ , $f_{\text{test}} = 1\text{ MHz}$ )	$C_{ob}$	—	—	500	pF

(1) Pulse Test: Pulse Width = 300  $\mu\text{s}$ , Duty Cycle  $\leq 2\%$

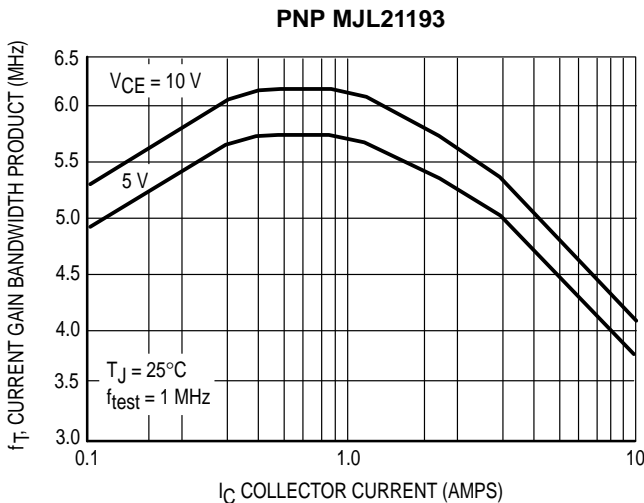

Figure 1. Typical Current Gain Bandwidth Product

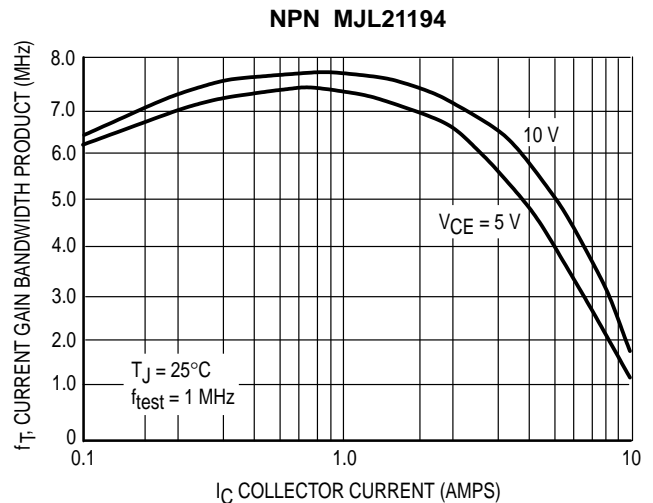

Figure 2. Typical Current Gain Bandwidth Product

TYPICAL CHARACTERISTICS

PNP MJL21193

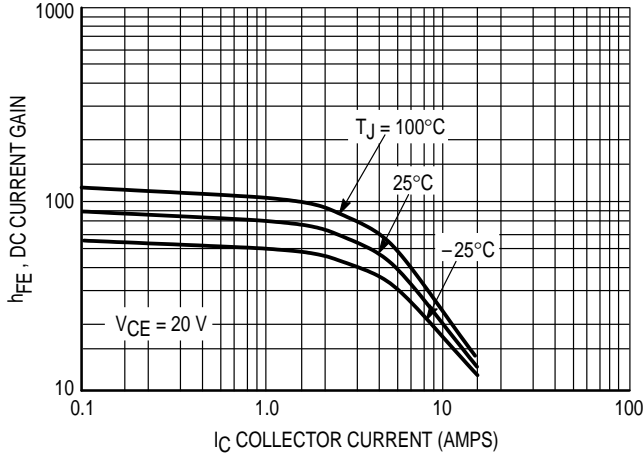

Figure 3. DC Current Gain,  $V_{CE} = 20\text{ V}$

NPN MJL21194

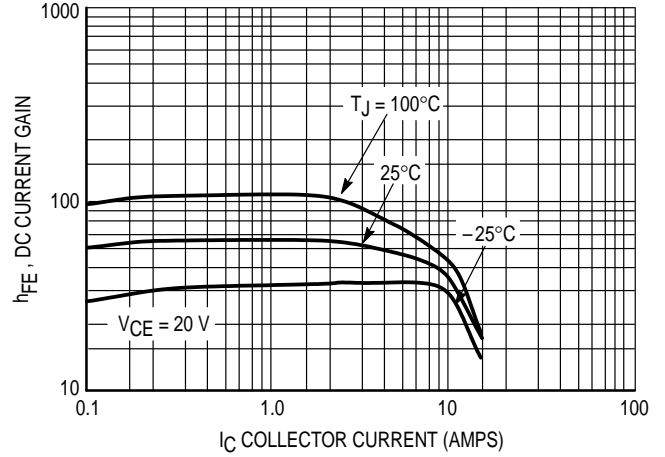

Figure 4. DC Current Gain,  $V_{CE} = 20\text{ V}$

PNP MJL21193

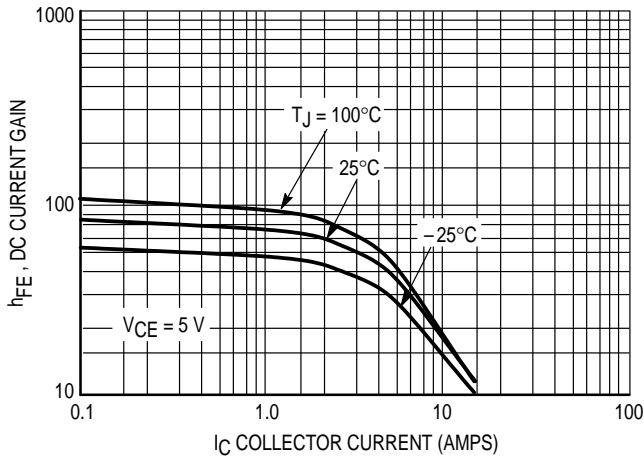

Figure 5. DC Current Gain,  $V_{CE} = 5\text{ V}$

NPN MJL21194

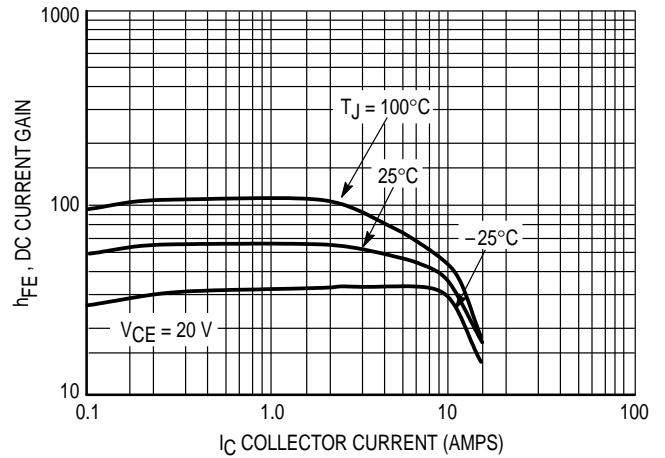

Figure 6. DC Current Gain,  $V_{CE} = 5\text{ V}$

PNP MJL21193

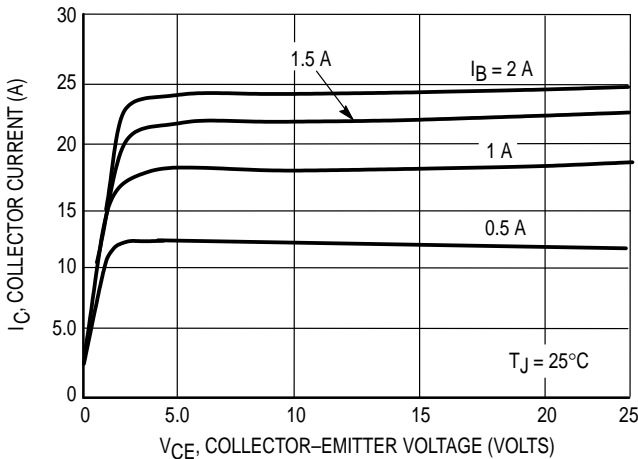

Figure 7. Typical Output Characteristics

NPN MJL21194

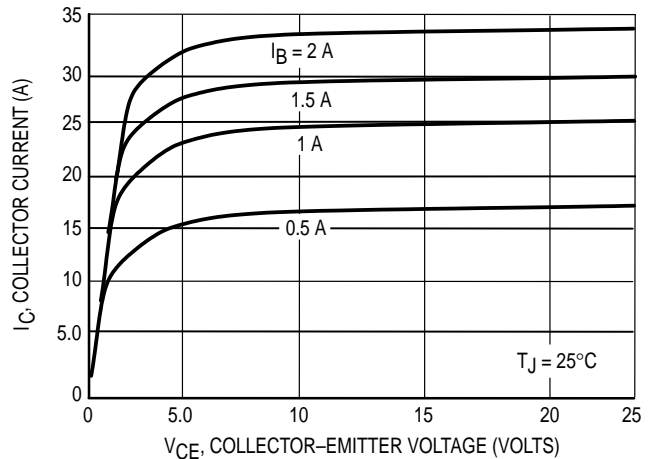

Figure 8. Typical Output Characteristics

TYPICAL CHARACTERISTICS

PNP MJL21193

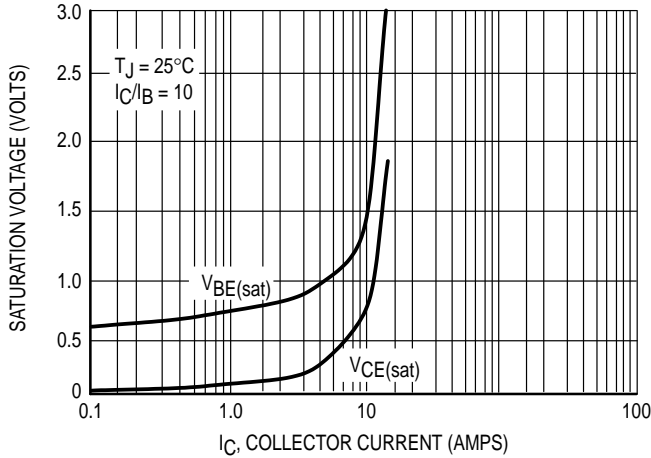

Figure 9. Typical Saturation Voltages

NPN MJL21194

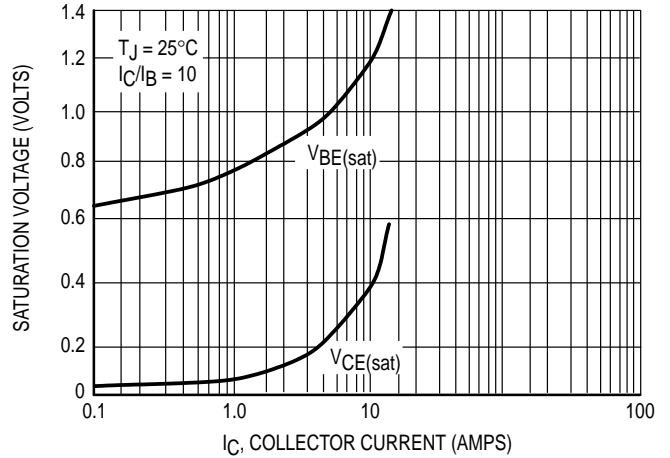

Figure 10. Typical Saturation Voltages

PNP MJL21193

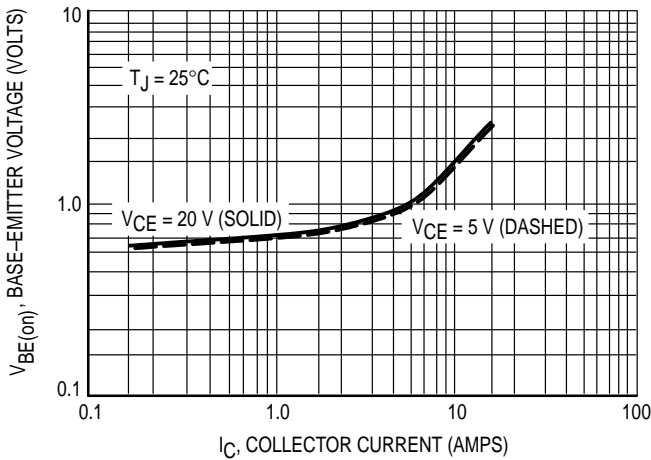

Figure 11. Typical Base-Emitter Voltage

NPN MJL21194

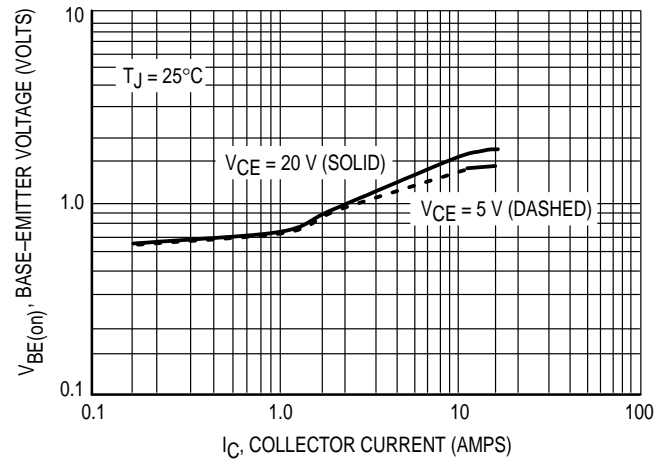

Figure 12. Typical Base-Emitter Voltage

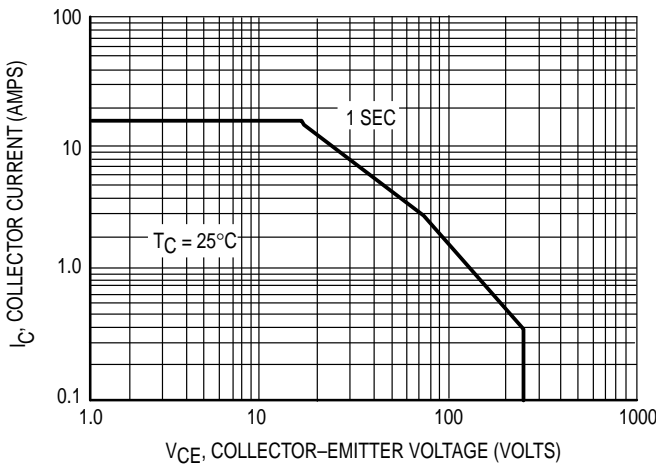

Figure 13. Active Region Safe Operating Area

There are two limitations on the power handling ability of a transistor; average junction temperature and secondary breakdown. Safe operating area curves indicate  $I_C - V_{CE}$  limits of the transistor that must be observed for reliable operation; i.e., the transistor must not be subjected to greater dissipation than the curves indicate.

The data of Figure 13 is based on  $T_{J(pk)} = 200^\circ\text{C}$ ;  $T_C$  is variable depending on conditions. At high case temperatures, thermal limitations will reduce the power than can be handled to values less than the limitations imposed by second breakdown.

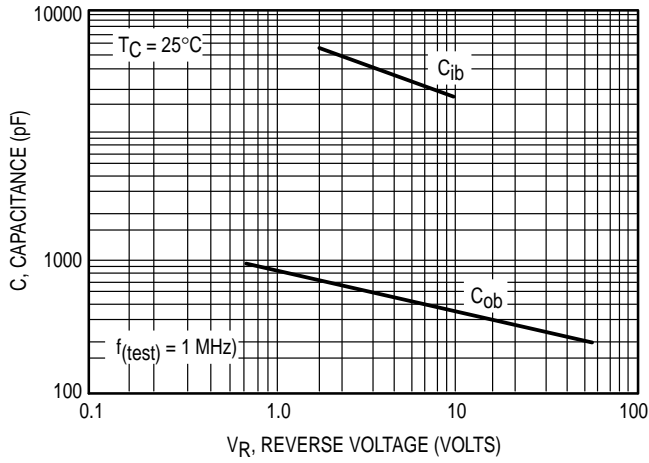

Figure 14. MJL21193 Typical Capacitance

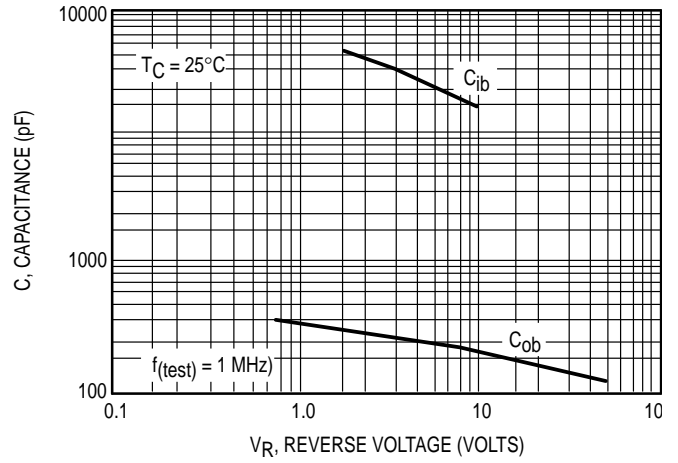

Figure 15. MJL21194 Typical Capacitance

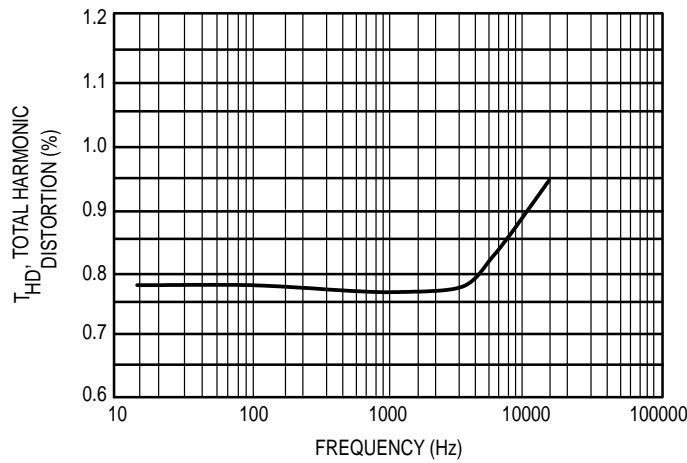

Figure 16. Typical Total Harmonic Distortion

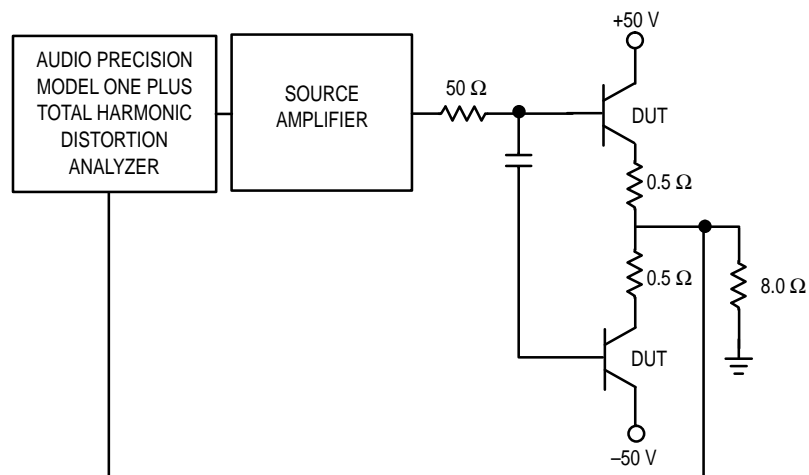
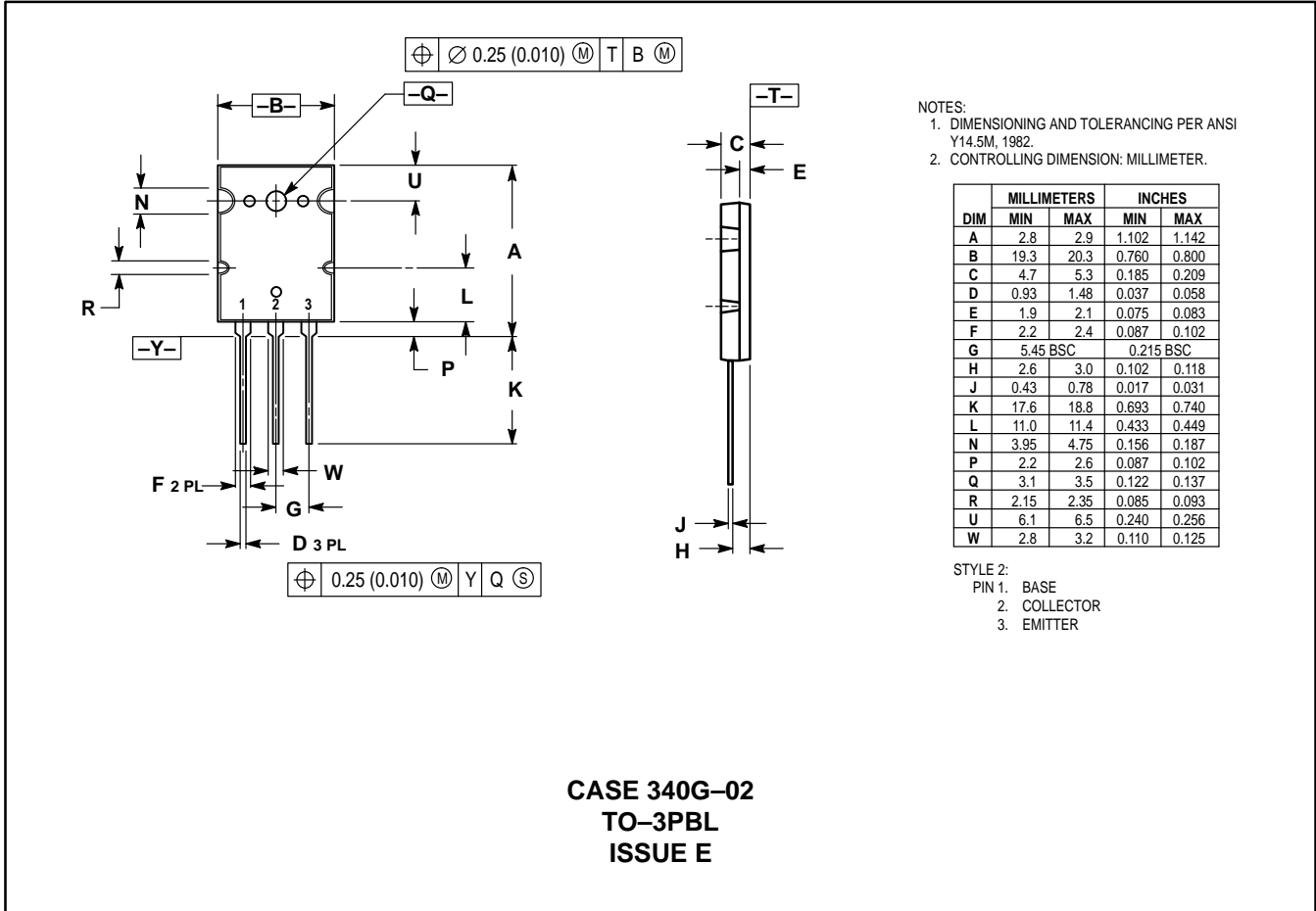

Figure 17. Total Harmonic Distortion Test Circuit

PACKAGE DIMENSIONS



Motorola reserves the right to make changes without further notice to any products herein. Motorola makes no warranty, representation or guarantee regarding the suitability of its products for any particular purpose, nor does Motorola assume any liability arising out of the application or use of any product or circuit, and specifically disclaims any and all liability, including without limitation consequential or incidental damages. "Typical" parameters can and do vary in different applications. All operating parameters, including "Typicals" must be validated for each customer application by customer's technical experts. Motorola does not convey any license under its patent rights nor the rights of others. Motorola products are not designed, intended, or authorized for use as components in systems intended for surgical implant into the body, or other applications intended to support or sustain life, or for any other application in which the failure of the Motorola product could create a situation where personal injury or death may occur. Should Buyer purchase or use Motorola products for any such unintended or unauthorized application, Buyer shall indemnify and hold Motorola and its officers, employees, subsidiaries, affiliates, and distributors harmless against all claims, costs, damages, and expenses, and reasonable attorney fees arising out of, directly or indirectly, any claim of personal injury or death associated with such unintended or unauthorized use, even if such claim alleges that Motorola was negligent regarding the design or manufacture of the part. Motorola and are registered trademarks of Motorola, Inc. Motorola, Inc. is an Equal Opportunity/Affirmative Action Employer.

**How to reach us:**  
**USA / EUROPE:** Motorola Literature Distribution;  
 P.O. Box 20912; Phoenix, Arizona 85036. 1-800-441-2447

**JAPAN:** Nippon Motorola Ltd.; Tatsumi-SPD-JLDC, Toshikatsu Otsuki,  
 6F Seibu-Butsuryu-Center, 3-14-2 Tatsumi Koto-Ku, Tokyo 135, Japan. 03-3521-8315

**MFAX:** RMFAX0@email.sps.mot.com - TOUCHTONE (602) 244-6609  
**INTERNET:** http://Design-NET.com

**HONG KONG:** Motorola Semiconductors H.K. Ltd.; 8B Tai Ping Industrial Park,  
 51 Ting Kok Road, Tai Po, N.T., Hong Kong. 852-26629298

