

**LA4282**

2-Channel 10 W AF Power Amplifier for Use in Home Stereo, TV Applications

Overview

The LA4282 is an IC which seals a high-output power amplifier for TVs and monitors in a compact package.

Features

- High-power 2-channel AF power amplifier
- Low distortion
- Minimum number of external parts required (no bootstrap capacitor required)
- Low pop noise at the time of power supply ON/OFF
- Good ripple rejection (58 dB typ)
- Wide operating voltage range
- External muting available
- On-chip protector against abnormality (thermal shutdown, overvoltage)

Package Dimensions

unit : mm

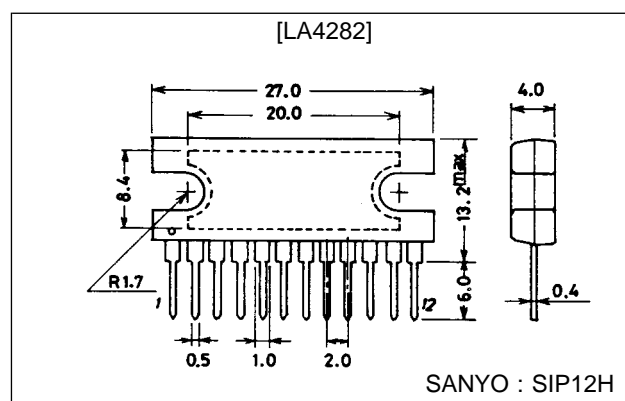
3049A-SIP12H

Specifications

Maximum Ratings at Ta = 25 °C

Parameter	Symbol	Conditions	Ratings	Unit
Maximum supply voltage	$V_{CC \text{ max}}$	Quiescent	45	V
Maximum output current	$I_{O \text{ peak}}$		4	A
Allowable power dissipation	$P_d \text{ max}$	With heat sink	25	W
Operating temperature	T_{opr}		-20 to +75	°C
Storage temperature	T_{stg}		-40 to +150	°C

Operating Conditions at Ta = 25°C

Parameter	Symbol	Conditions	Ratings	Unit
Recommended supply voltage	V_{CC}		32	V
	$V_{CC \text{ op}}$		10 to 40	V
Recommended load resistance	R_L		8	Ω

LA4282

**Operating Characteristics at $T_a = 25^\circ\text{C}$, $V_{CC} = 32\text{ V}$, $R_L = 8\ \Omega$, $f = 1\text{ kHz}$, $R_g = 600\ \Omega$,
See Test Circuit.**

Parameter	Symbol	Conditions	min	typ	max	Unit
Quiescent current	$I_{CCO(1)}$	Quiescent	30	60	100	mA
	$I_{CCO(2)}$	Muting switch On	30	56	100	mA
Voltage gain	VG		38	40	42	dB
Voltage gain difference	ΔVG				1.5	dB
Output power	$P_O(1)$	THD = 1%	9.0	10.0		W
	$P_O(2)$	THD = 3%	10.0	11.5		W
Total harmonic distortion	THD	$P_O = 2\text{ W}$		0.05	0.20	%
Output noise voltage	V_{NO}	$R_g = 10\text{ k}\Omega$, BW = 20 Hz to 20 kHz		0.25	1.0	mV
Ripple rejection	SVRR	$R_g = 10\text{ k}\Omega$, $f_R = 100\text{ Hz}$, $V_R = 0\text{ dBm}$	45	58		dB
Crosstalk	CT	$R_g = 10\text{ k}\Omega$	45	60		dB
Muting	$V_{O(MT)}$	Muting switch On, $V_{IN} = -5\text{ dBm}$			-35	dBm

Equivalent Circuit Block Diagram and Pin Assignment

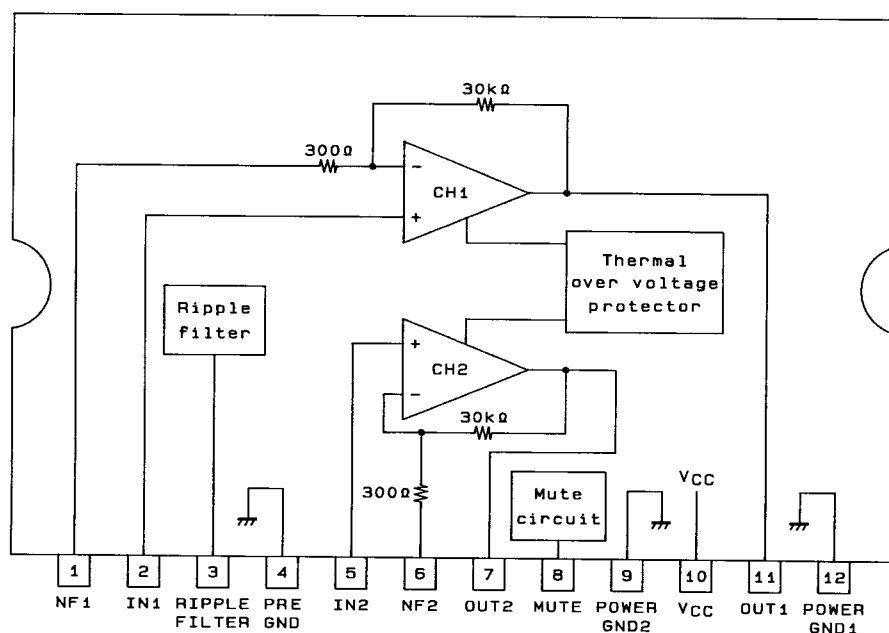

A05005

LA4282

Test Circuit

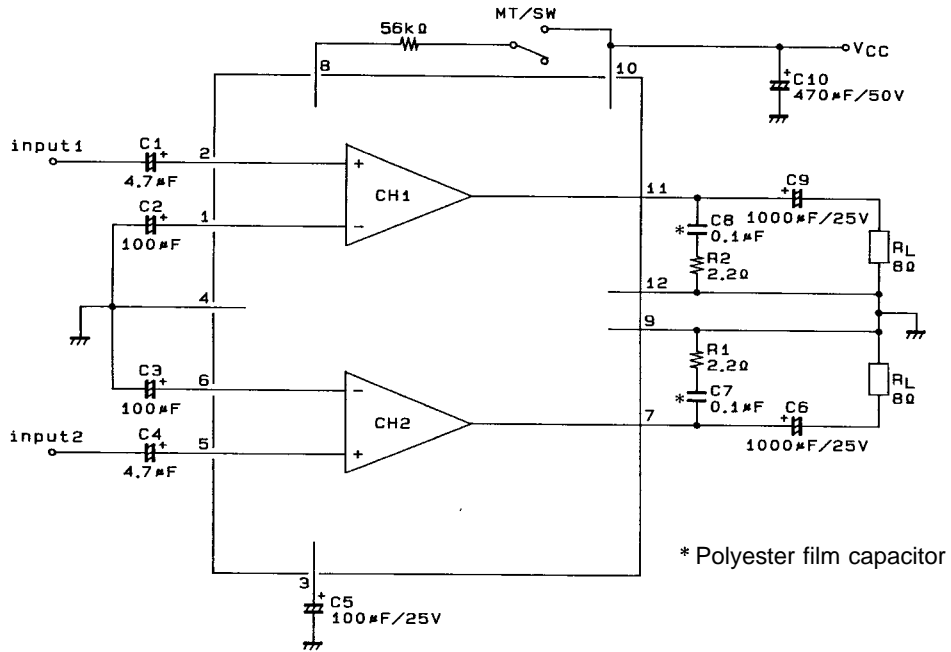

A05006

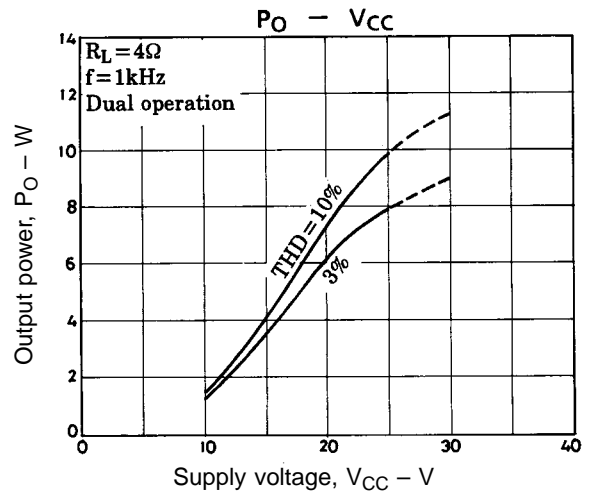
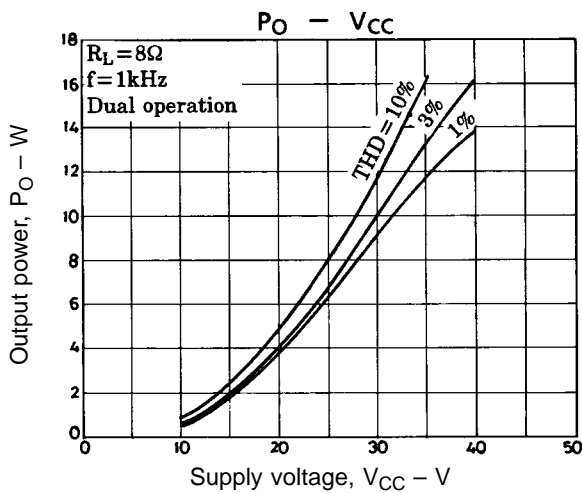
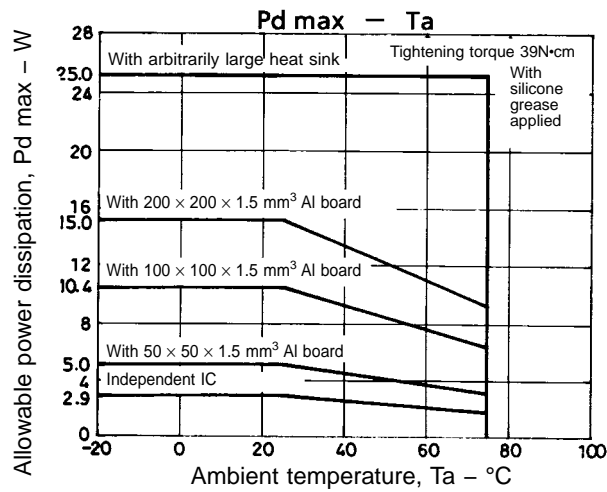

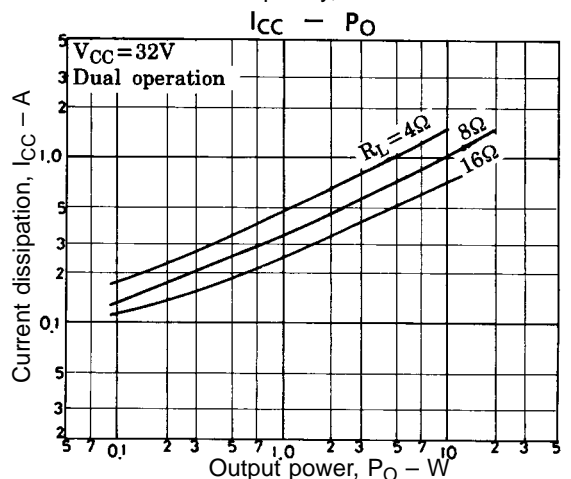
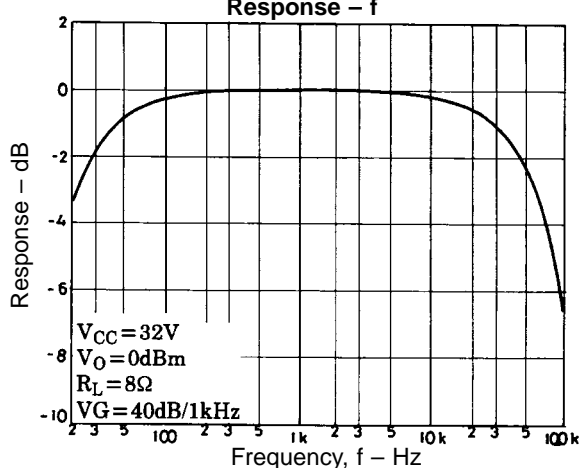
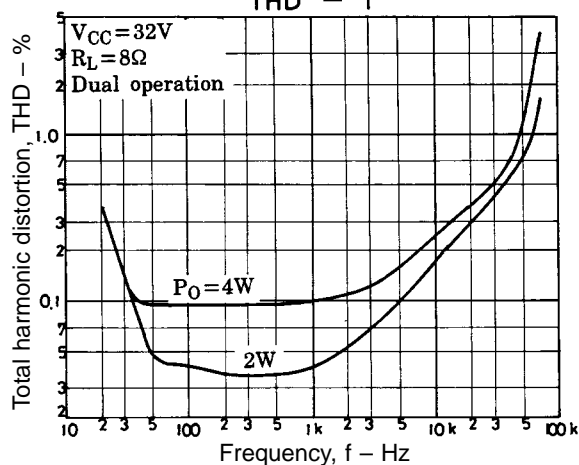
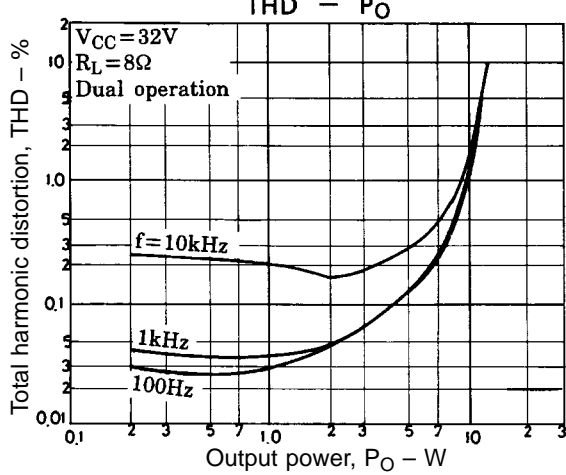
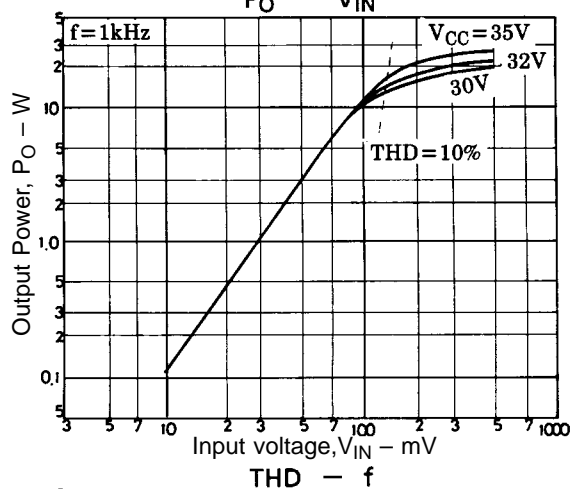
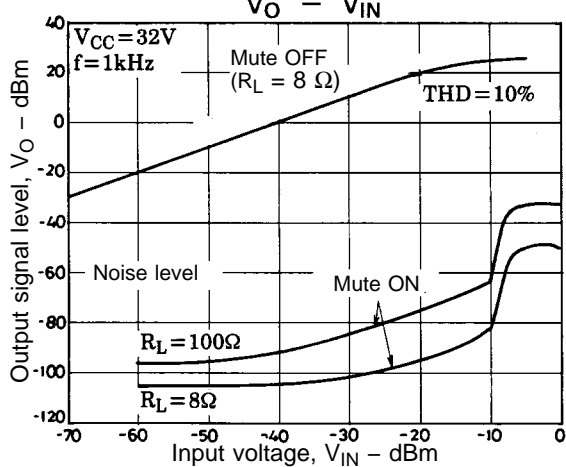
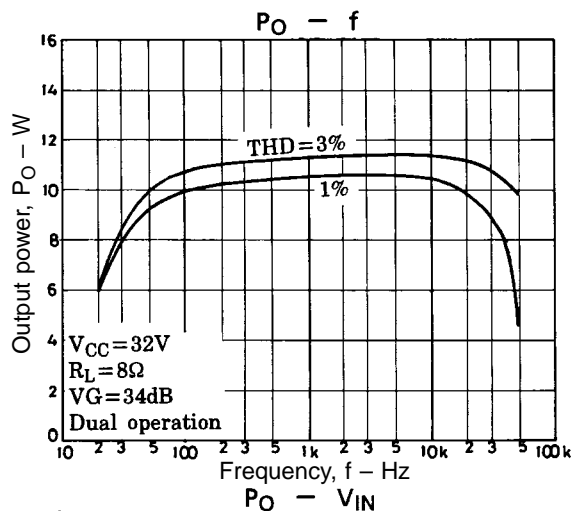
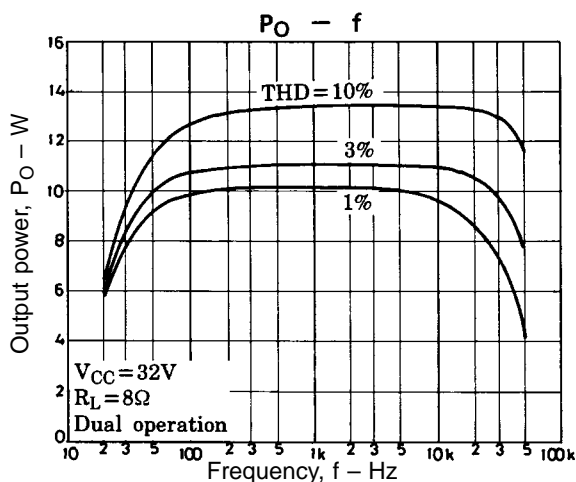

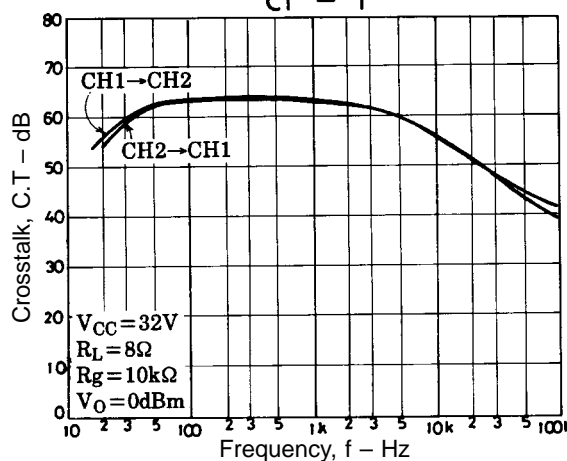
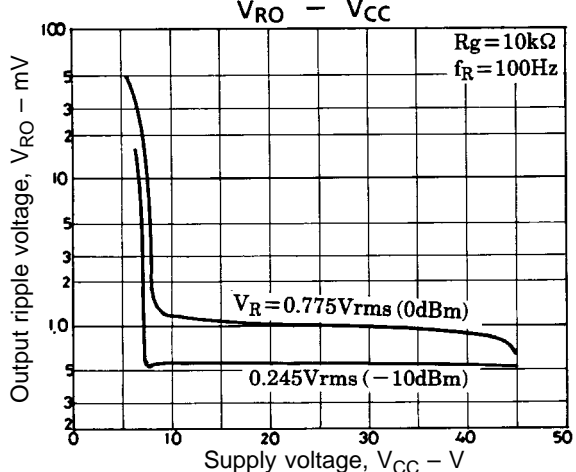
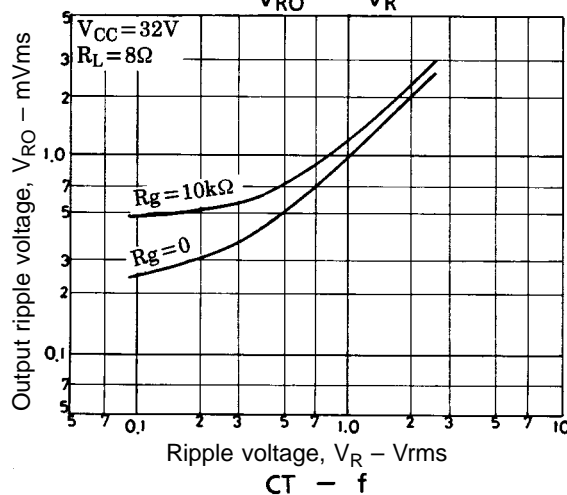
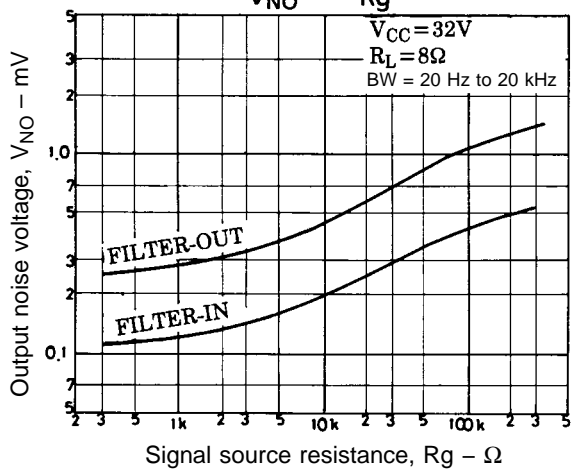
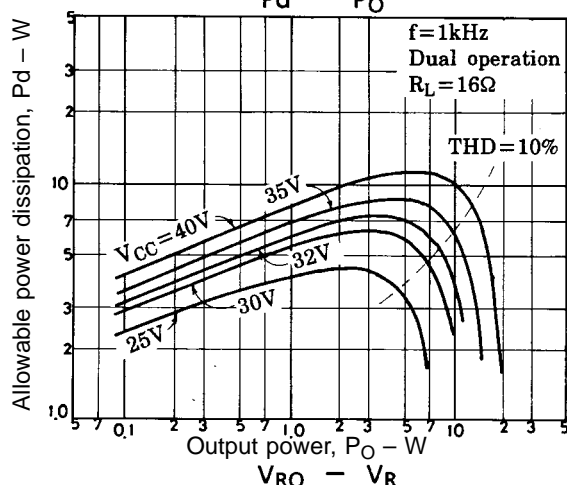
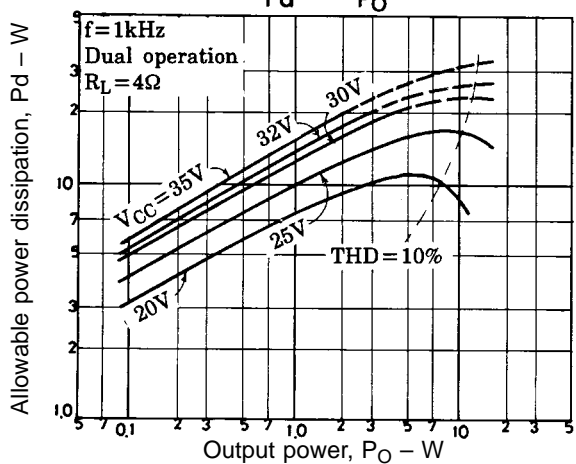
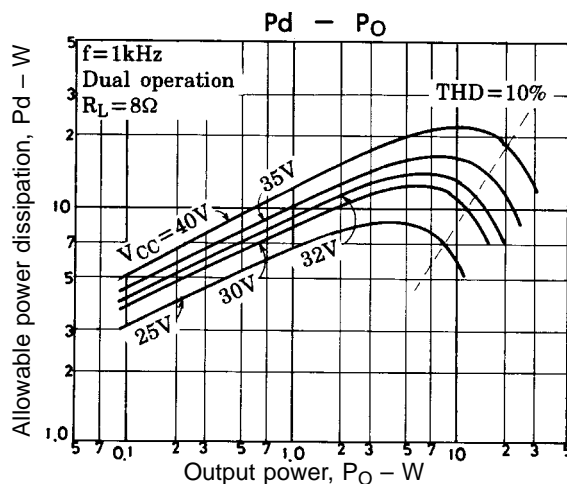
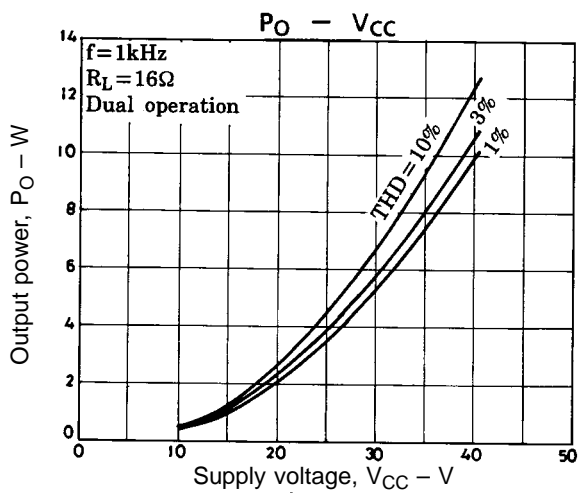

- No products described or contained herein are intended for use in surgical implants, life-support systems, aerospace equipment, nuclear power control systems, vehicles, disaster/crime-prevention equipment and the like, the failure of which may directly or indirectly cause injury, death or property loss.
- Anyone purchasing any products described or contained herein for an above-mentioned use shall:
 - ① Accept full responsibility and indemnify and defend SANYO ELECTRIC CO., LTD., its affiliates, subsidiaries and distributors and all their officers and employees, jointly and severally, against any and all claims and litigation and all damages, cost and expenses associated with such use:
 - ② Not impose any responsibility for any fault or negligence which may be cited in any such claim or litigation on SANYO ELECTRIC CO., LTD., its affiliates, subsidiaries and distributors or any of their officers and employees jointly or severally.
- Information (including circuit diagrams and circuit parameters) herein is for example only; it is not guaranteed for volume production. SANYO believes information herein is accurate and reliable, but no guarantees are made or implied regarding its use or any infringements of intellectual property rights or other rights of third parties.

This catalog provides information as of February, 1996. Specifications and information herein are subject to change without notice.