

AN1324 (AN6564), AN1324NS (AN6564NS)

Quadruple Operational Amplifiers

■ Overview

The AN1324 (AN6564) and the AN1324NS (AN6564NS) are quadruple operational amplifiers with phase compensation circuits built-in, and with wide range of operating voltages, allowing single power supply operation. They have electrical characteristics equal to the conventional operational amplifiers, and are low powered and suitable for application to various circuits.

■ Features

- Built-in phase compensation circuit
- Wide range of common-mode input voltage
0V to $V_{CC}-1.5V$
- Wide range of operating voltages
Single supply: 3 to 30V
Dual supply: ± 1.5 to 15V

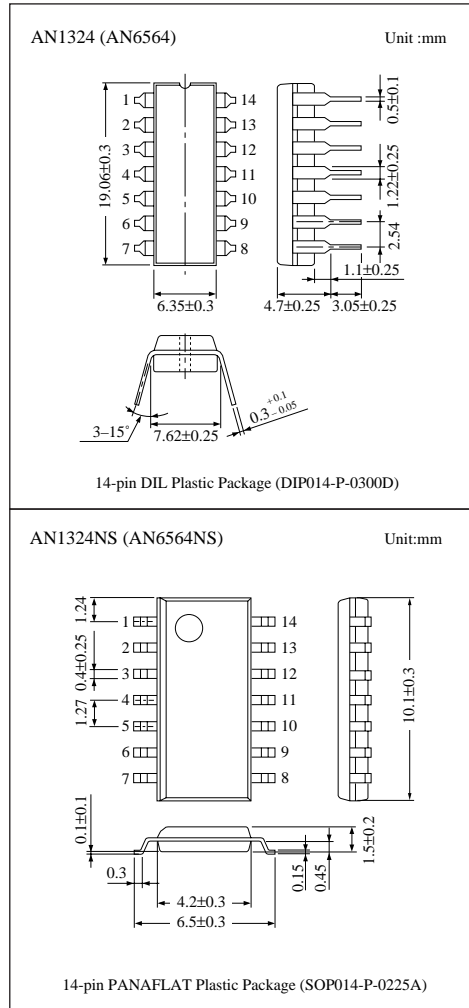

■ Block Diagram

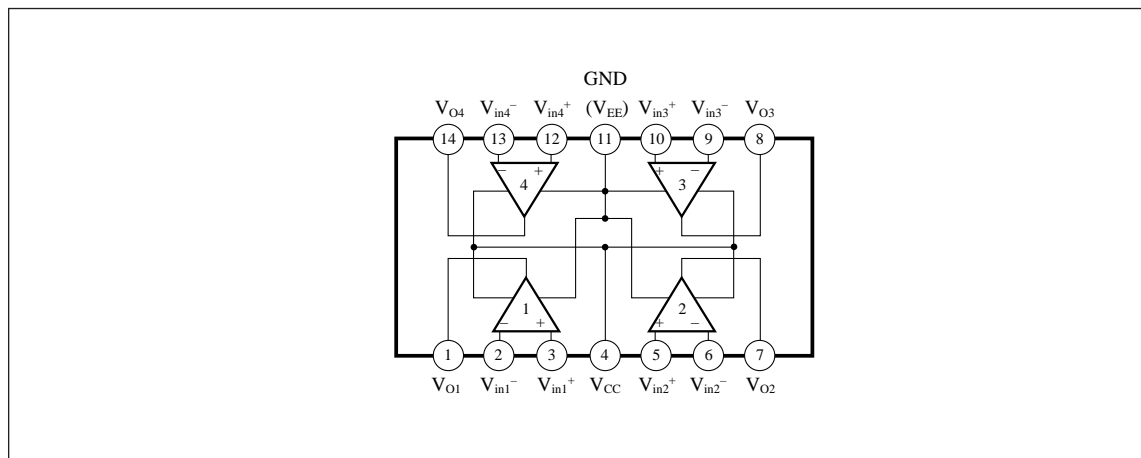

■ Pin Descriptions

Pin No.	Pin name	Pin No.	Pin name
1	Ch.1 output	8	Ch.3 output
2	Ch.1 inverting input	9	Ch.3 inverting input
3	Ch.1 non inverting input	10	Ch.3 non inverting input
4	V _{CC}	11	GND (V _{EE})
5	Ch.2 non inverting input	12	Ch.4 non inverting input
6	Ch.2 inverting input	13	Ch.4 inverting input
7	Ch.2 output	14	Ch.4 output

■ Absolute Maximum Ratings (T_a=25°C)

Parameter		Symbol	Rating	Unit
Voltage	Supply voltage	V _{CC}	32	V
	Differential input voltage	V _{ID}	32	V
	Common-mode input voltage	V _{ICM}	-0.3 to 32	V
	Output voltage	V _O	24	V
Power dissipation	AN1324 (AN6564)	P _D	570	mW
	AN1324NS (AN6564NS)		380	
Operating ambient temperature		T _{opr}	-20 to +75	°C
Storage temperature	AN1324 (AN6564)	T _{stg}	-55 to +150	°C
	AN1324NS (AN6564NS)		-55 to +125	

■ Electrical Characteristics (V_{CC}=5V, T_a=25°C)

Parameter	Symbol	Condition	min	typ	max	Unit
Input offset voltage	V _{I(offset)}	R _S =50Ω	—	2	7	mV
Input bias current	I _{Bias}		—	—	500	nA
Input offset current	I _{IO}		—	—	50	nA
Common-mode input voltage range	V _{CM}		0	—	V _{CC} -1.5	V
Supply current	I _{CC}	R _L =∞	—	—	2	mA
Voltage gain	G _V	R _L ≥2kΩ	—	100	—	dB
Maximum output voltage	V _{O(max.)}	R _L =2kΩ	V _{CC} -1.5	—	—	V
Common-mode rejection ratio	CMR		65	85	—	dB
Supply voltage rejection ratio	SVR		65	100	—	dB
Channel separation	CS	f=1kHz to 20kHz	—	120	—	dB
Output source current	I _{O(source)}	V _{in+} =1V, V _{in-} =0V	20	40	—	mA
Output sink current	I _{SINK}	V _{in+} =0V, V _{in-} =1V	10	20	—	mA

■ Characteristics Curve

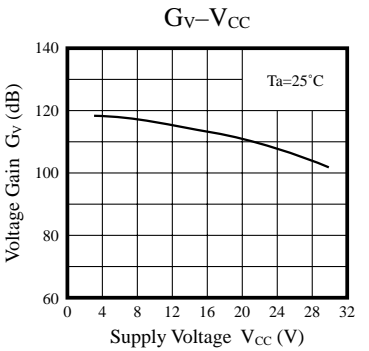
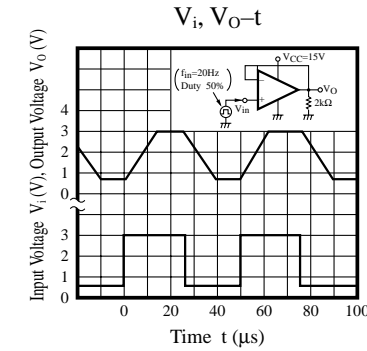
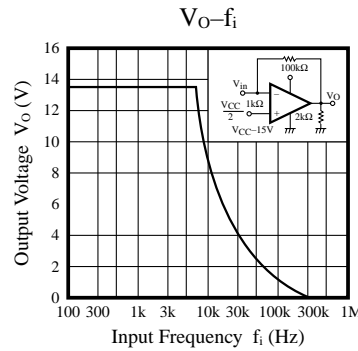
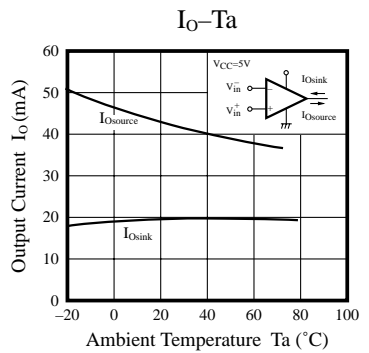
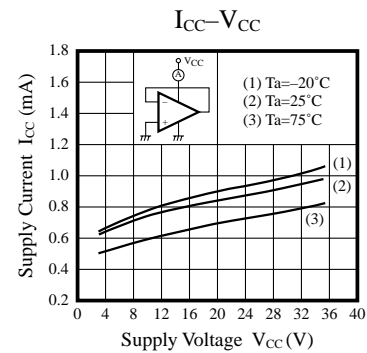
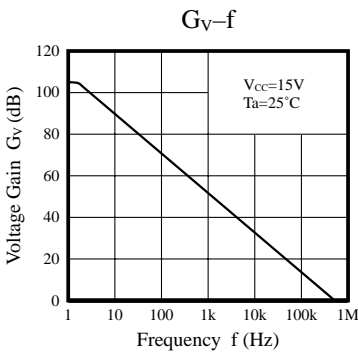
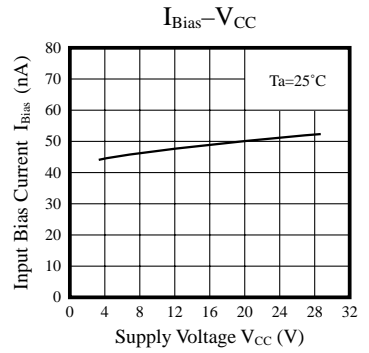
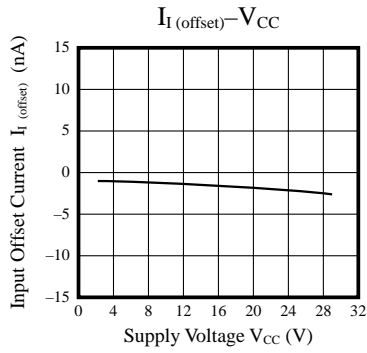
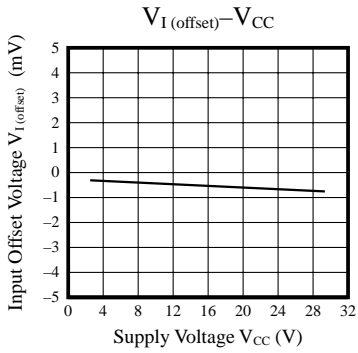

■ Application Circuit

Positive Phase Amplifier

