



**NON-BASE LEAD
OPTICALLY COUPLED ISOLATOR
PHOTOTRANSISTOR OUTPUT**

APPROVALS

- UL recognised, File No. E91231

'X' SPECIFICATION APPROVALS

- VDE 0884 approval pending
- EN60950 approval pending

DESCRIPTION

The CNX62A optically coupled isolator consists of an infrared light emitting diode and a NPN silicon photo transistor in a standard 6 pin dual in line plastic package with the base pin unconnected.

FEATURES

- Options :-
10mm lead spread - add G after part no.
Surface mount - add SM after part no.
Tape&reel - add SMT&R after part no.
- High Current Transfer Ratio (40% min)
- Low Saturation Voltage suitable for TTL integrated circuits
- High BV_{CEO} (50V min)
- High Isolation Voltage ($5.3kV_{RMS}$, $7.5kV_{PK}$)
- Base pin unconnected for improved noise immunity in high EMI environment

APPLICATIONS

- DC motor controllers
- Industrial systems controllers
- Signal transmission between systems of different potentials and impedances

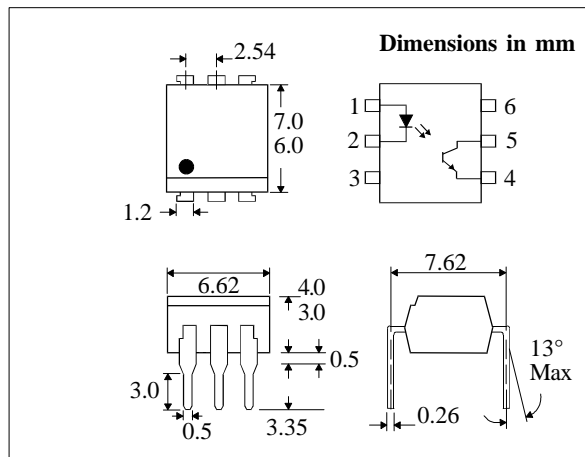
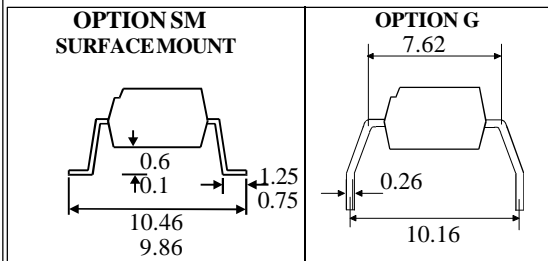

**ABSOLUTE MAXIMUM RATINGS
(25°C unless otherwise specified)**

Storage Temperature	-55°C to + 150°C
Operating Temperature	-55°C to + 100°C
Lead Soldering Temperature (1/16 inch (1.6mm) from case for 10 secs)	260°C

INPUT DIODE

Forward Current	60mA
Reverse Voltage	6V
Power Dissipation	105mW

OUTPUT TRANSISTOR

Collector-emitter Voltage BV_{CEO}	50V
Emitter-collector Voltage BV_{ECO}	6V
Power Dissipation	160mW

POWER DISSIPATION

Total Power Dissipation	200mW
(derate linearly 2.67mW/°C above 25°C)	

ISOCOM COMPONENTS LTD
Unit 25B, Park View Road West,
Park View Industrial Estate, Brenda Road
Hartlepool, Cleveland, TS25 1YD
Tel: (01429) 863609 Fax :(01429) 863581

ISOCOM INC
1024 S. Greenville Ave, Suite 240,
Allen, TX 75002 USA
Tel: (214)495-0755 Fax: (214)495-0901
e-mail info@isocom.com
http://www.isocom.com

ELECTRICAL CHARACTERISTICS ($T_A = 25^\circ\text{C}$ Unless otherwise noted)

PARAMETER		MIN	TYP	MAX	UNITS	TEST CONDITION
Input	Forward Voltage (V_F)		1.2	1.5	V	$I_F = 10\text{mA}$
	Reverse Voltage (V_R)	6			V	$I_R = 10\mu\text{A}$
	Reverse Current (I_R)			10	μA	$V_R = 6\text{V}$
Output	Collector-emitter Breakdown (BV_{CEO}) (Note 2)	50			V	$I_C = 1\text{mA}$
	Emitter-collector Breakdown (BV_{ECO})	6			V	$I_E = 100\mu\text{A}$
	Collector-emitter Dark Current (I_{CEO})			50	nA	$V_{CE} = 10\text{V}$
Coupled	Current Transfer Ratio (I_C / I_F) (Note 2)	0.4	1.5			$10\text{mA } I_F, 0.4\text{V } V_{CE}$ $10\text{mA } I_F, 5\text{V } V_{CE}$
	Collector-emitter Saturation Voltage $V_{CE(SAT)}$			0.4	V	$10\text{mA } I_F, 4\text{mA } I_C$
	Input to Output Isolation Voltage V_{ISO}	5300 7500			V_{RMS} V_{PK}	See note 1 See note 1
	Input-output Isolation Resistance R_{ISO}	5×10^{10}			Ω	$V_{IO} = 500\text{V}$ (note 1)
	Turn-on Time t_{on}		3		μs	$V_{CC} = 5\text{V}, I_C = 2\text{mA},$ $R_L = 100\Omega$
	Turn-off Time t_{off}		3		μs	$V_{CC} = 5\text{V}, I_C = 2\text{mA},$ $R_L = 1\text{k}\Omega$
	Turn-on Time t_{on}		12		μs	$V_{CC} = 5\text{V}, I_C = 2\text{mA},$ $R_L = 1\text{k}\Omega$
Turn-off Time t_{off}		12		μs	$V_{CC} = 5\text{V}, I_C = 2\text{mA},$ $R_L = 1\text{k}\Omega$	

Note 1 Measured with input leads shorted together and output leads shorted together.

Note 2 Special Selections are available on request. Please consult the factory.

Collector Power Dissipation vs. Ambient Temperature

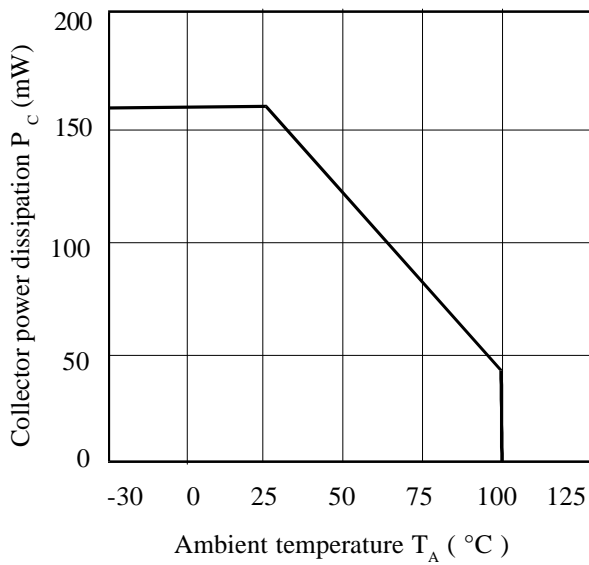

Collector Current vs. Collector-emitter Voltage

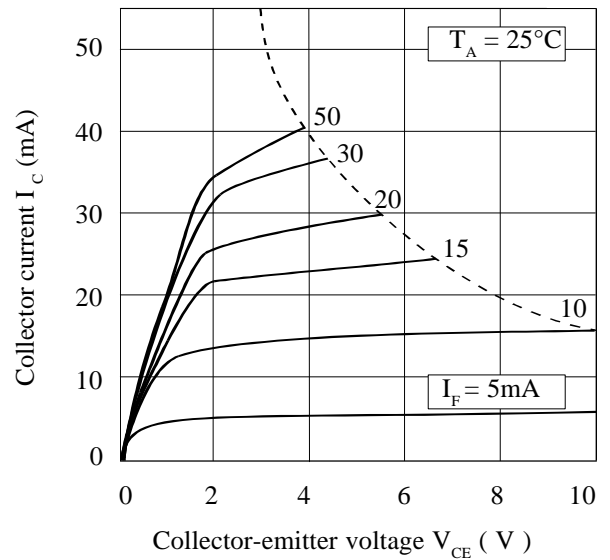

Forward Current vs. Ambient Temperature

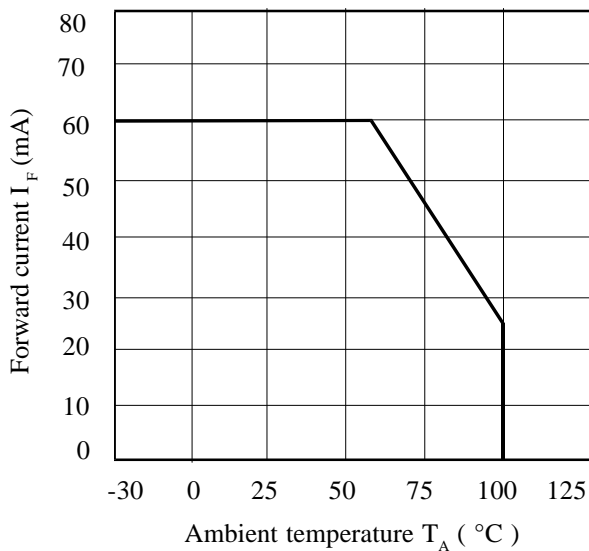

Collector-emitter Saturation Voltage vs. Ambient Temperature

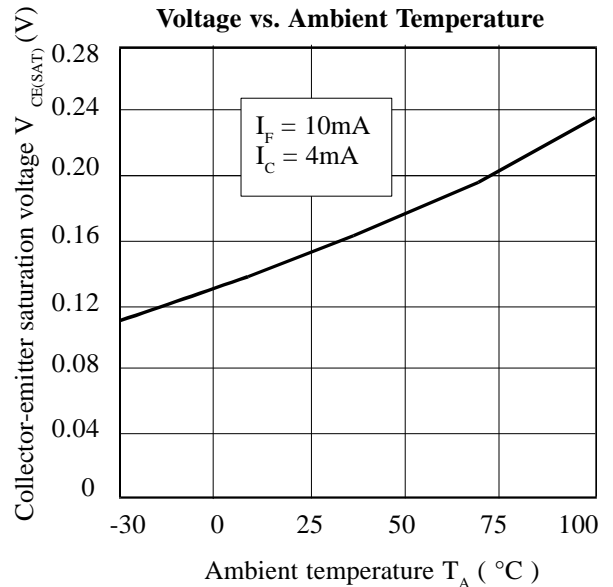

Relative Current Transfer Ratio vs. Ambient Temperature

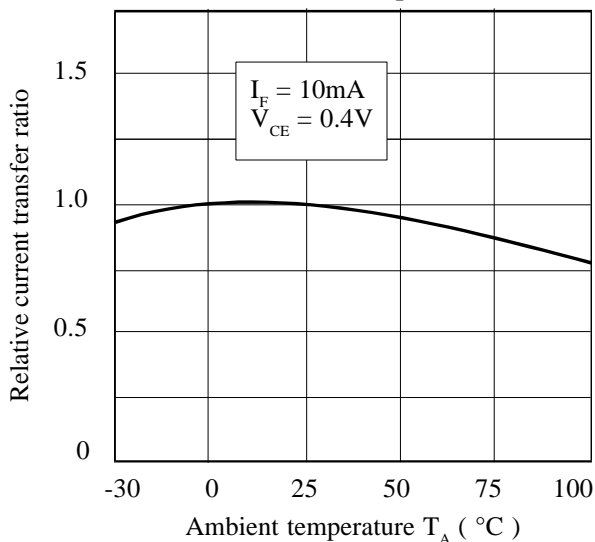

Relative Current Transfer Ratio vs. Forward Current

