

Very Low Distortion Attenuator Plastic Packaged PIN Diodes



SMP1307 Series

Features

- Low Distortion Design
- Frequency Range from HF to > 2 GHz
- Designed for CATV AGC Applications
- Designed for High Volume Wireless Applications

Description

The SMP1307 series of plastic packaged, surface mountable, low capacitance (0.3 pF) silicon PIN diodes are designed for use in attenuator applications from 5 MHz to beyond 2 GHz. The thick 175 μm I region of these PIN diodes makes them very attractive for use in very low distortion PI and TEE attenuators commonly used in TV distribution applications. The 1.5 μS typical carrier lifetime of these diodes results in resistance of 100 Ω maximum at 1 mA and 10 Ω maximum at 10 mA. Available in a selection of plastic packages, as a single diode in the small footprint SOD-323, and in a variety of configurations in the SOT-23. Also available in a SOT-5 (SMP1307-027) package as a four diode array designed for insertion in the commonly used 4 diode PI attenuator circuit.

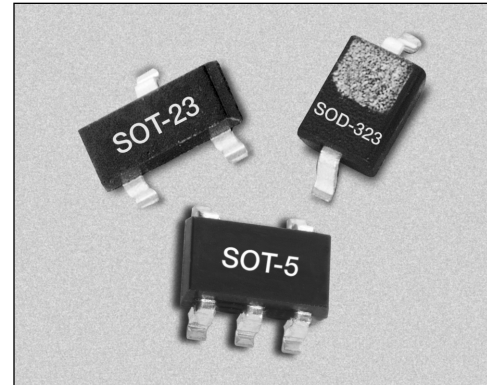

Absolute Maximum Ratings

Characteristic	Value
Reverse Voltage (V_R)	200 V
Power Dissipation @ 25°C Lead Temperature (P_D)	250 mW
Storage Temperature (T_{ST})	-65°C to +150°C
Operating Temperature (T_{OP})	-65°C to +150°C
ESD Human Body Model	Class 1C

Single	Common Cathode	Series Pair	Single	PI
Marking: PJ1	Marking: PJ3	Marking: PJ2		Marking: PJM
SOT-23	SOT-23	SOT-23	SOD-323	SOT-5
♦ SMP1307-001	♦ SMP1307-004	♦ SMP1307-005	♦ SMP1307-011	♦ SMP1307-027
$L_S = 1.5 \text{ nH}$	$L_S = 1.5 \text{ nH}$	$L_S = 1.5 \text{ nH}$	$L_S = 1.5 \text{ nH}$	

♦ Available through distribution.

Electrical Specifications at 25°C

Parameter	Condition	Typ.	Max.	Unit
Reverse Current (I_R)	$V_R = 200 \text{ V}$		10	μA
Capacitance (C_T)	$F = 1 \text{ MHz}, V = 30 \text{ V}$		0.30	pF
Resistance (R_S)	$F = 100 \text{ MHz}, I = 1 \text{ mA}$	75	100	Ω
Resistance (R_S)	$F = 100 \text{ MHz}, I = 10 \text{ mA}$		15	Ω
Resistance (R_S)	$F = 100 \text{ MHz}, I = 100 \text{ mA}$		3.0	Ω
Forward Voltage (V_F)	$I_F = 10 \text{ mA}$	0.85		V
Carrier Lifetime (TI)	$I_F = 10 \text{ mA}$	1.5		μS
I Region Width		175		μm

Typical Performance Data

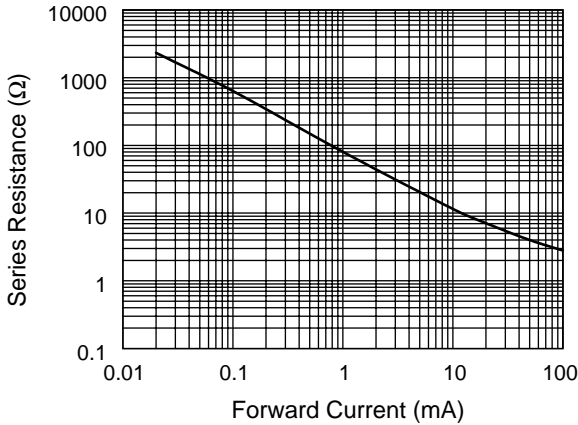

Series Resistance vs. Current @ 100 MHz

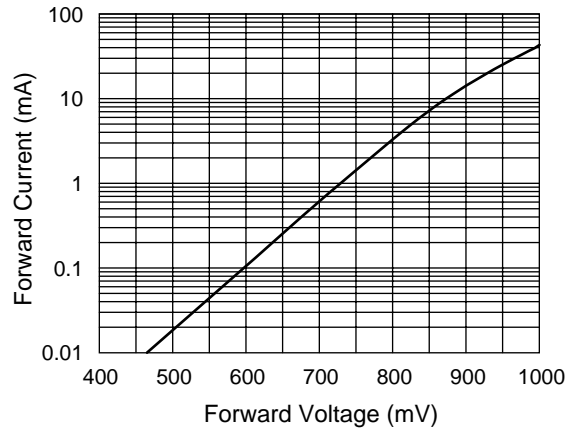

DC Characteristic

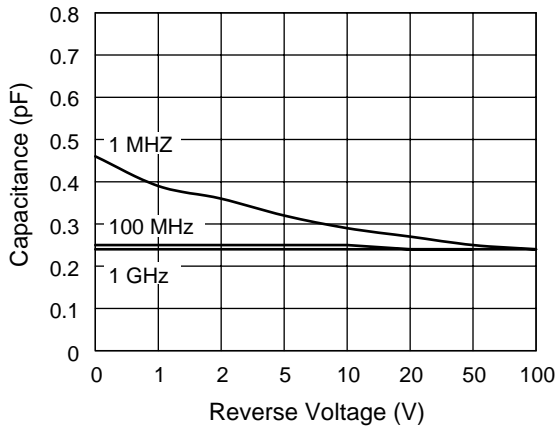

Capacitance vs. Reverse Voltage

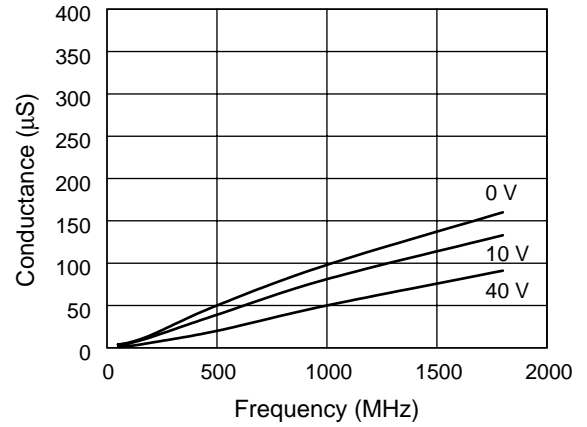

Conductance vs. Frequency and Reverse Voltage

Resistance vs. Temperature @ 100 MHz

I_F (mA)	R -55°C (Ω)	R -15°C (Ω)	R +25°C (Ω)	R +65°C (Ω)	R +100°C (Ω)
0.02	2386.0	2360.0	2546.0	2520.0	2440.0
0.10	572.0	598.0	632.0	633.0	639.0
0.30	203.0	219.0	236.0	239.0	242.0
1.00	66.1	71.2	79.3	83.6	85.4
10.00	9.1	10.0	10.9	12.2	12.9
20.00	5.6	6.0	6.6	7.4	7.8
100.00	2.2	2.4	2.6	3.0	3.2

SMP1307-027 4 Diode PI Attenuator

The SMP1307-027 employs 4 PIN diode junctions in a 5-lead SOT package. It is configured for ease of insertion in the PI attenuator circuit commonly used for broadband TV distribution systems, covering a frequency range from 5 MHz to beyond 1 GHz.

A broadband attenuator was designed using the SMP1307-027 showing good performance to 2 GHz. The attenuator was evaluated with a 50 Ω source and load impedance. The following figure shows the circuit diagram and measured performance.

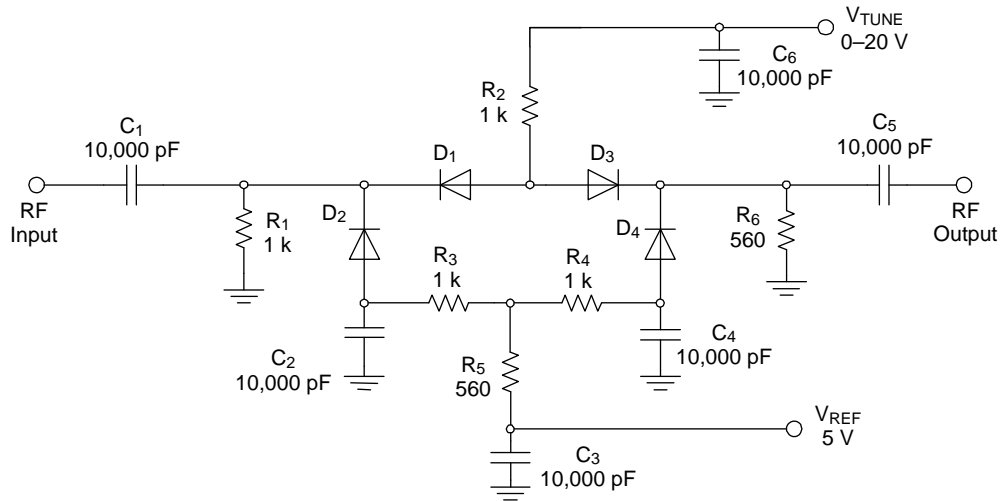
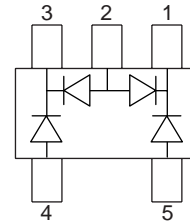

D₁-D₄ SMP1307-027

A 4 diode PI attenuator utilizing individual SMP1307-011 PIN diodes is described in the "A Wideband General Purpose PIN Diode Attenuator" Application Note.

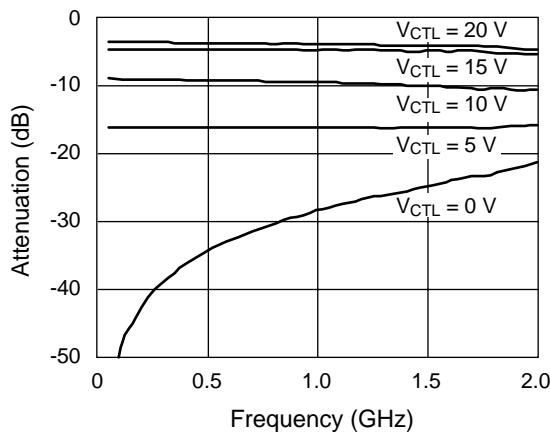

SMP1307-027 Attenuation vs. Frequency

SOT-23

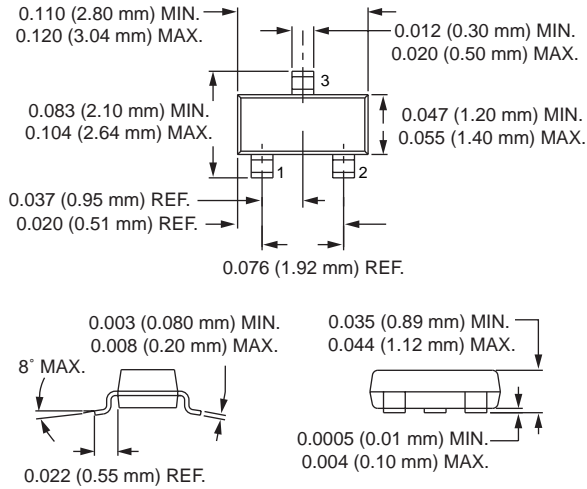

SOT-5

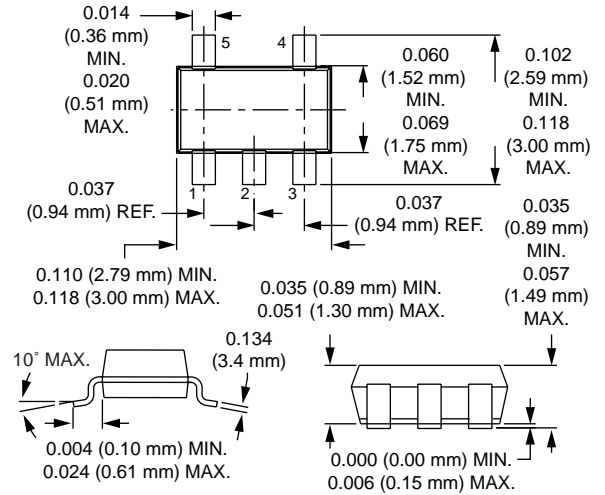

SOD-323

