

Silicon PIN Diode

- High voltage current controlled
RF resistor for RF attenuator and switches
- Frequency range above 1 MHz
- Low resistance and short carrier lifetime
- For frequencies up to 3 GHz

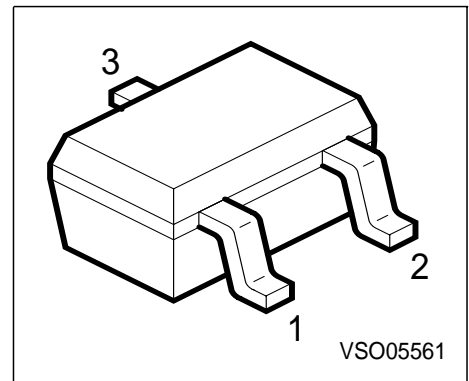

BAR 64-04W

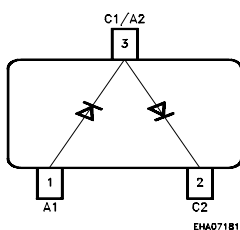

BAR 64-05W

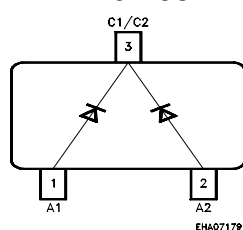

BAR 64-06W

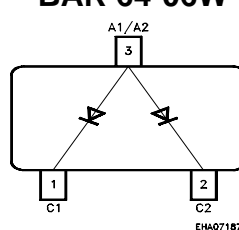

Type	Marking	Ordering Code	Pin Configuration			Package
BAR 64-04W	PPs	Q62702-A1264	1 = A1	2 = C2	3=C1/A2	SOT-323
BAR 64-05W	PRs	Q62702-A1265	1 = A1	2 = C2	3 = C1/2	
BAR 64-06W	PSs	Q62702-A1266	1 = C1	2 = C2	3 = A1/2	

Maximum Ratings

Parameter	Symbol	Value	Unit
Diode reverse voltage	V_R	200	V
Forward current	I_F	100	mA
Total power dissipation, $T_S \leq 115\text{ °C}$	P_{tot}	250	mW
Junction temperature	T_j	150	°C
Operating temperature range	T_{op}	- 55 ...+150	
Storage temperature	T_{stg}	- 55 ...+150	

Thermal Resistance

Junction - ambient ¹⁾	R_{thJA}	≤ 300	K/W
Junction - soldering point	R_{thJS}	≤ 140	

1) Package mounted on alumina 15mm x 16.7mm x 0.7mm

Electrical Characteristics at $T_A = 25^\circ\text{C}$, unless otherwise specified.

Parameter	Symbol	Values			Unit
		min.	typ.	max.	
DC characteristics					
Breakdown voltage $I_{(BR)} = 5 \mu\text{A}$	$V_{(BR)}$	200	-	-	V
Reverse current $V_R = 20 \text{ V}$	I_R	-	-	50	μA
Forward voltage $I_F = 50 \text{ mA}$	V_F	-	-	1.1	mV
AC characteristics					
Diode capacitance $V_R = 20 \text{ V}, f = 1 \text{ MHz}$	C_T	-	0.23	0.35	pF
Forward resistance $I_F = 1 \text{ mA}, f = 100 \text{ MHz}$ $I_F = 10 \text{ mA}, f = 100 \text{ MHz}$ $I_F = 100 \text{ mA}, f = 100 \text{ MHz}$	r_f	-	12.5 2.1 0.85	20 2.8 1.35	Ω
Charge carrier life time $I_F = 10 \text{ mA}, I_R = 6 \text{ mA}, I_R = 3 \text{ mA}$	τ_{rr}	-	1.55	-	μs
Series inductance	L_S	-	1.2	-	nH

Forward current $I_F = f(T_A^*; T_S)$

* mounted on alumina

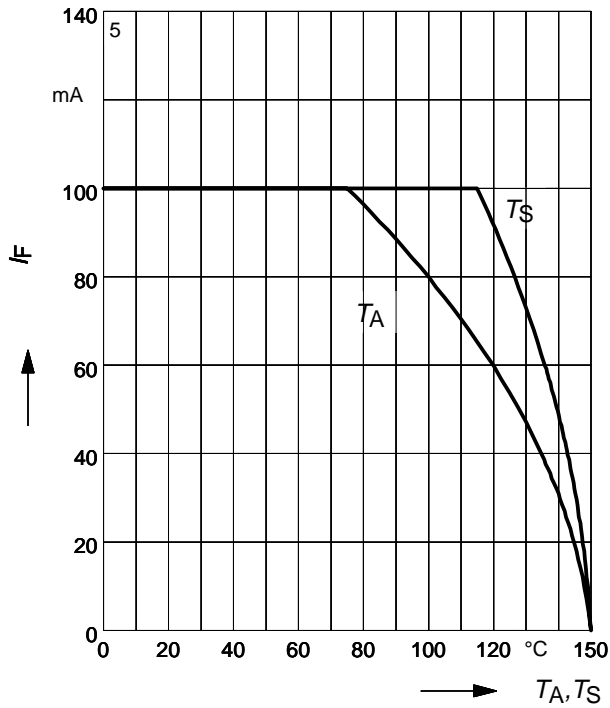

Permissible Pulse Load $R_{thJS} = f(t_p)$

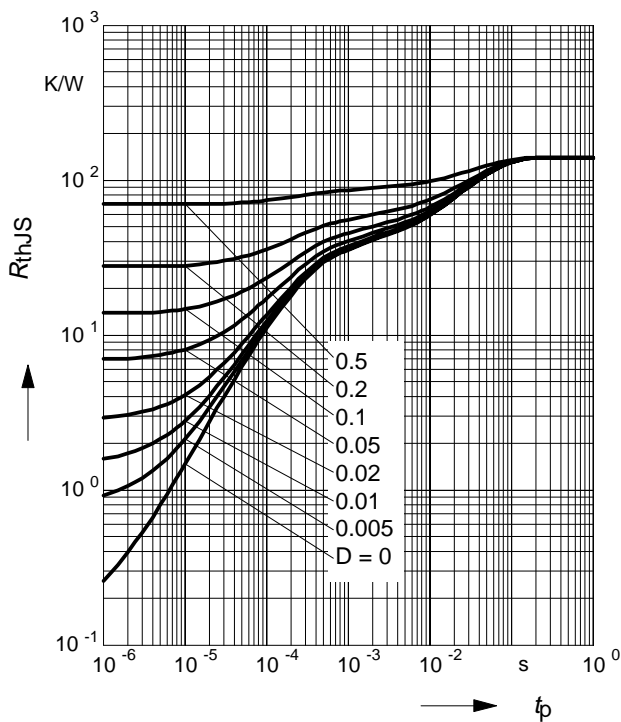

Permissible Pulse Load

$$I_{Fmax} / I_{FDC} = f(t_p)$$

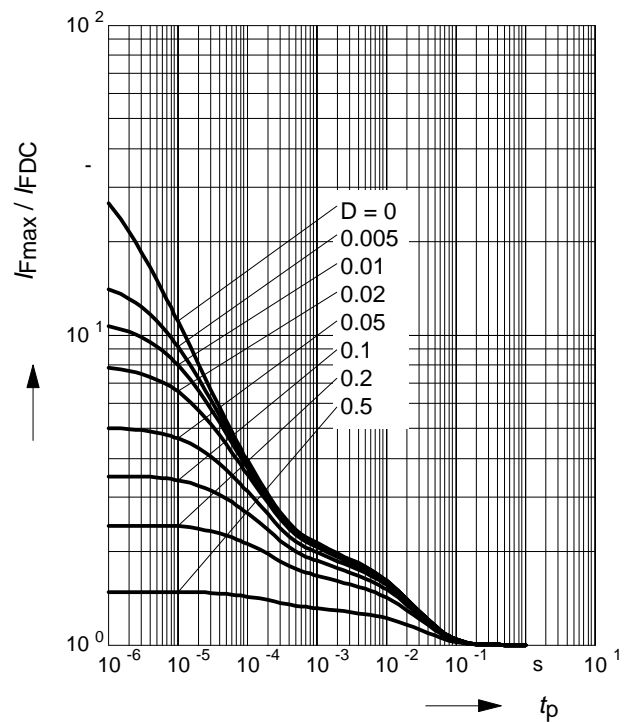

Diode capacitance $C_T = f(V_R)$

$f = 1\text{MHz}$

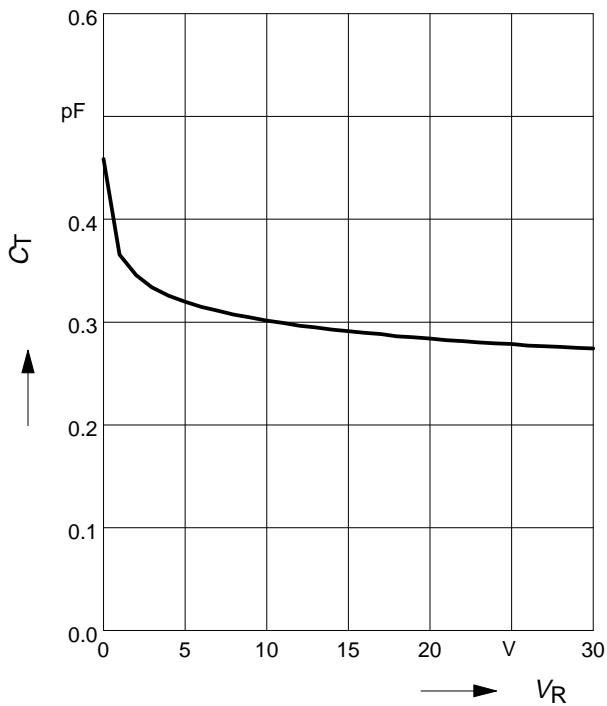

Forward resistance $r_f = f(I_F)$

$f = 100\text{MHz}$

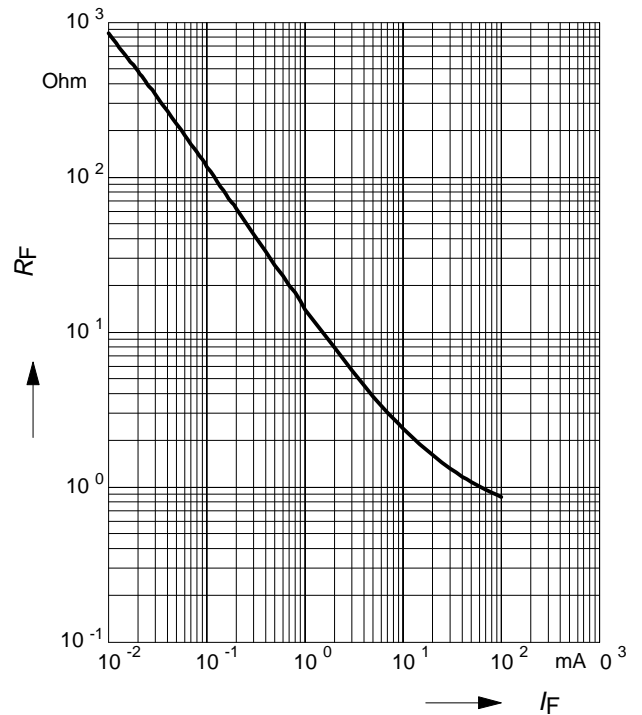

Forward current $I_F = f(V_F)$

$T_A = \text{parameter}$

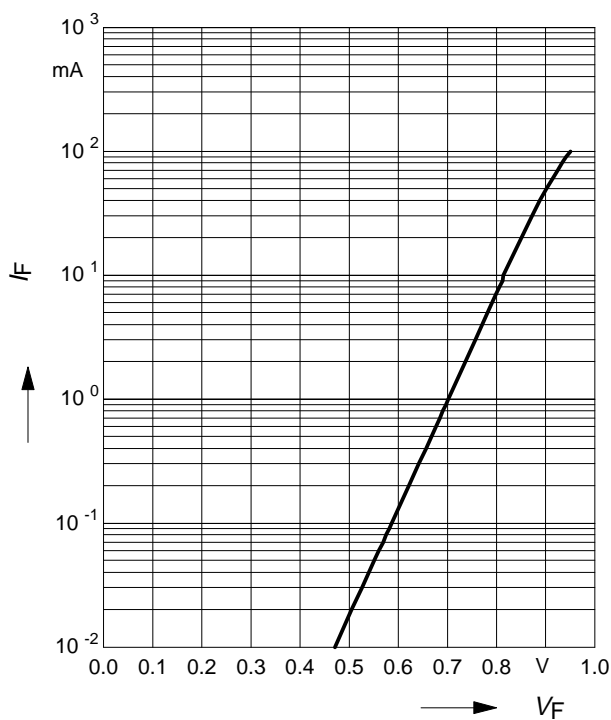

Intermodulation intercept point $IP_3 = f(I_F)$

$f = \text{parameter}$

