

5.0V LOW POWER PRECISION REFERENCE SOURCE

ZRT050

ISSUE 1 - OCTOBER 1995

DEVICE DESCRIPTION

The ZRT050 is a monolithic integrated circuit providing a precise stable reference voltage of 4.9V at 500 μ A.

The circuit features a knee current of 150 μ A and operation over a wide range of temperatures and currents.

The ZRT050 is available in a 3-pin metal can package for through hole applications as well as SOT223 and SO8 packages for surface mount applications. Each package option offers a trim facility whereby the output voltage can be adjusted as shown in Fig.1. This facility is used when compensating for system errors or setting the reference output to a particular value. When the trim facility is not used, the pin should be left open circuit.

FEATURES

- Trimmable output
- Excellent temperature stability
- Low output noise figure
- Available in two temperature ranges
- 1 and 2% initial voltage tolerance versions available
- No external stabilising capacitor required in most cases
- Low slope resistance
- TO18 package
- SOT223 and SO8 small outline packages

SCHEMATIC DIAGRAM

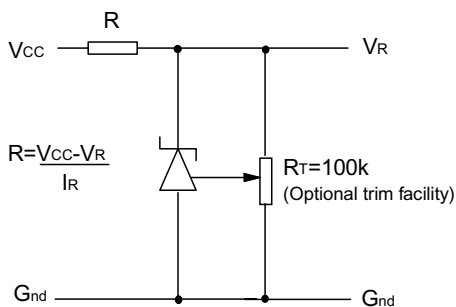

Figure 1:

This circuit will allow the reference to be trimmed over a wide range. The device is specified over a $\pm 5\%$ trim range.

ZRT050

ABSOLUTE MAXIMUM RATING

Reverse Current	60mA \emptyset
Operating Temperature	
A grade	-55°C to 125°C
C grade	0°C to 70°C
Storage Temperature	
TO18	-55 °C to 175 °C
SO8, SOT223	-55 °C to 125 °C

Power Dissipation ($T_{amb}=25^{\circ}\text{C}$)

TO18	300mW
SO8	625mW
SOT223	2W
\emptyset Above 25°C this figure should be linearly derated to 12mA at 125°C	

TEMPERATURE DEPENDENT ELECTRICAL CHARACTERISTICS

SYMBOL	PARAMETER	INITIAL VOLTAGE TOLERANCE %	GRADE A -55°C TO 125°C		GRADE C 0°C TO 70°C		UNITS
			TYP	MAX	TYP	MAX	
ΔV_R	Output voltage change over relevant temperature range (See note (a))	1 & 2	13.5	45.0	5.4	17.2	mV
$T_C V_R$	Output voltage temperature coefficient (See note (b))	1 & 2	15.0	50.0	15.0	50.0	ppm/°C

ELECTRICAL CHARACTERISTICS

(at $T_{amb}=25^{\circ}\text{C}$ and trim pin unless otherwise stated)

SYMBOL	PARAMETER	MIN.	TYP.	MAX.	UNITS	COMMENTS
V_R	Output voltage 1% tolerance (A1,C1) 2% tolerance (C2)	4.85 4.80	4.90 4.90	4.95 5.00	V	$I_R=500\mu\text{A}$
ΔV_{TRIM}	Output voltage adjustment range		± 5		%	$R_T=100\text{k}\Omega$
$T_C \Delta V_{TRIM}$	Change in $T_C V_R$ with output adjustment		2.5		ppm/°C/%	
I_R	Operating current range	0.15		60	mA	See note (c)
t_{on} t_{off}	Turn-on time Turn-off time		100 0.3		μs	$R_L=1\text{k}\Omega$
e_{np-p}	Output voltage noise (over the range 0.1 to 10Hz)		50		μV	Peak to peak measurement
R_S	Slope resistance		1.25	2.0	Ω	$I_R = 0.5\text{mA}$ to 5mA See note (d)

TYPICAL CHARACTERISTICS

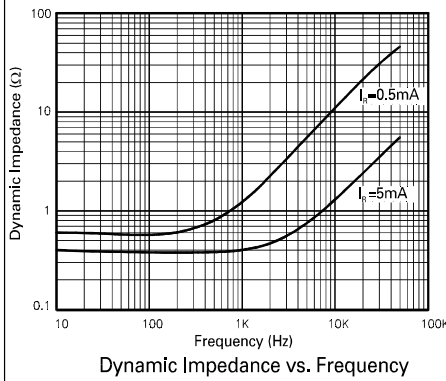
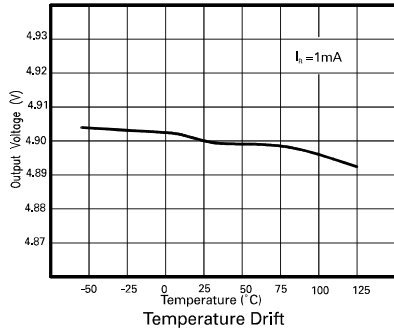
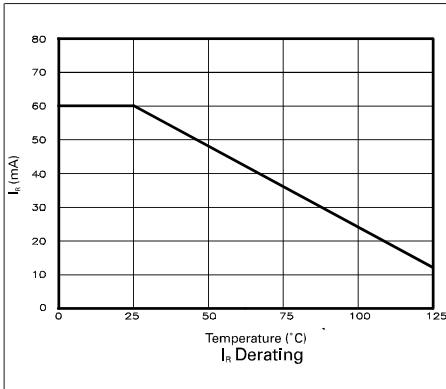

NOTES

(a) Output change with temperature (V_R)

The absolute maximum difference between the maximum output voltage and the minimum output voltage over the specified temperature range

$$\Delta V_R = V_{max} - V_{min}$$

(b) Output temperature coefficient (T_cV_R)

The ratio of the output change with temperature to the specified temperature range expressed in ppm/°C

$$T_c V_R = \frac{\Delta V_R \times 10^6}{V_R \times \Delta T} \text{ ppm}/^\circ\text{C}$$

ΔT = Full temperature range

(c) Operating current (I_R)

Maximum operating current must be derated as indicated in maximum ratings.

(d) Slope resistance (R_S)

The slope resistance is defined as :

$$R_S = \frac{\text{change in } V_R}{\text{specified current range}}$$

$$\Delta I = 5 - 0.5 = 4.5 \text{ mA (typically)}$$

(e) Line regulation

The ratio of change in output voltage to the change in input voltage producing it.

$$\frac{R_S \times 100}{V_R \times R_{S_{source}}} \% / V$$

ZRT050

CONNECTION DIAGRAMS

SOT223 Package Suffix - G

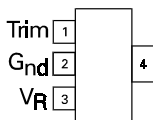

Top View
Pin 4 floating or connected to pin 2

TO18 Package Suffix - None

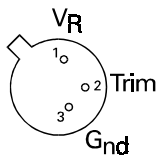

Bottom View -
Case is internally connected to pin 3

SO8 Package Suffix - N8

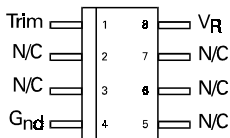

Top View

ORDERING INFORMATION

Part No	Tol%	Operating Temp.(°C)	Package	Partmark
ZRT050C2	2	0 to 70	TO18	ZRT050C2
ZRT050C1	1	0 to 70	TO18	ZRT050C1
ZRT050A1	1	-55 to 125	TO18	ZRT050A1
ZRT050GC2	2	0 to 70	SOT223	ZRT050C2
ZRT050GC1	1	0 to 70	SOT223	ZRT050C1
ZRT050GA1	1	-55 to 125	SOT223	ZRT050A1
ZRT050N8C2	2	0 to 70	SO8	ZRT050C2
ZRT050N8C1	1	0 to 70	SO8	ZRT050C1
ZRT050N8A1	1	-55 to 125	SO8	ZRT050A1