

**Bright Red MST4110C, MST4140C
High Efficiency Red MST4910C, MST4940C
Green MST4410C, MST4440C**

TR/QTS/030100-001

PACKAGE DIMENSIONS

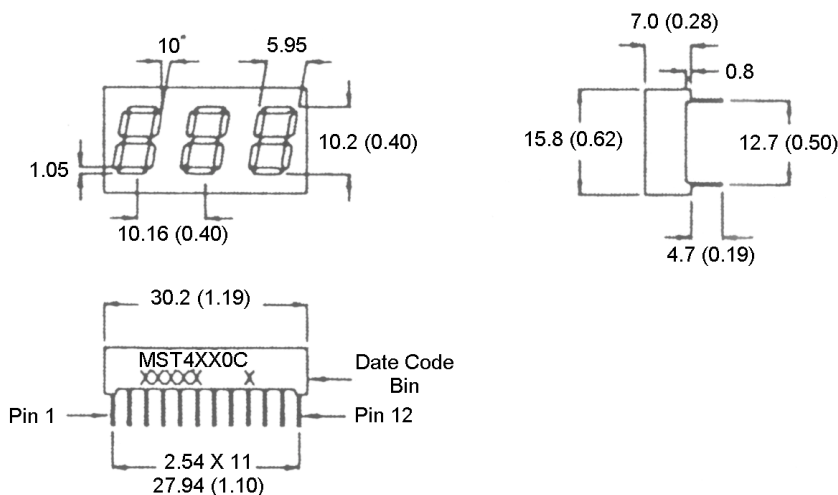

FEATURES

- Bright Bold Segments
- Common Anode/Cathode
- Low Power Consumption
- Low Current Capability
- Neutral Segments
- Grey Face
- Epoxy Encapsulated PCB
- High Performance
- High Reliability

APPLICATIONS

- Appliances
- Automotive
- Instrumentation
- Process Control

NOTES:

- Dimensions are in mm (inches)
- Tolerances are +/- 0.25 (0.010) unless otherwise stated.

MODELS AVAILABLE

Part Number	Colour	Description
MST4110C	Bright Red	Three Digit, RHDP, Common Anode
MST4140C	Bright Red	Three Digit, RHDP, Common Cathode
MST4410C	Green	Three Digit, RHDP, Common Anode
MST4440C	Green	Three Digit, RHDP, Common Cathode
MST4910C	High Efficiency Red	Three Digit, RHDP, Common Anode
MST4Y40C	High Efficiency Red	Three Digit, RHDP, Common Cathode

(For other colour options, contact your local area Sales Manager)

ABSOLUTE MAXIMUM RATINGS⁽¹⁾ ($T_A = 25^\circ\text{C}$, unless otherwise specified)

Part Number	MST4110C	MST4410C	MST4910C	
Parameter	MST4140C	MST4440C	MST4940C	Units
Continuous Forward Current (each segment)	15	25	25	mA
Peak Forward Current ($F = 10\text{KHz}$, $D/F = 1/10$)	60	90	90	mA
Power Dissipation (P_D)	40	70	70	mW
*Derate Linearly from 25°C	0.17	0.33	0.33	mW
Reverse Voltage per Die				5 Volts
Operating and Storage Temperature Range				-40°C to $+85^\circ\text{C}$
Lead soldering time (1/16 inch from standoffs)				5 seconds @ 230°C

ELECTRO-OPTICAL CHARACTERISTICS⁽¹⁾ ($T_A = 25^\circ\text{C}$, unless otherwise specified)

Part Number	MST4110C	MST4410C	MST4910C		
Parameter	MST4140C	MST4440C	MST4940C	Units	Test Condition
Luminous intensity⁽²⁾ (I_V)					
Minimum (Standard Current)	320	850	800	ucd	$I_F = 20\text{mA}$
Typical (Standard Current)	800	2200	2200	ucd	$I_F = 20\text{mA}$
Minimum (Low Current)	Not Available				
Typical (Low Current)	Not Available				
Forward Voltage (V_F)					
Typical (Standard Current)	2.10	2.10	2.00	Volts	$I_F = 20\text{mA}$
Maximum (Standard Current)	2.60	2.80	2.80	Volts	$I_F = 20\text{mA}$
Typical (Low Current)	Not Available				
Maximum (Low Current)	Not Available				
Peak Wavelength	697	570	635	nm	$I_F = 20\text{mA}$
Dominant Wavelength	Not Available				
Spectral Line 1/2 Width	90	30	45	nm	$I_F = 10\text{mA}$
Reverse B⁽³⁾.Voltage (V_R)	5	5	5	Volts	$I_R = 100\mu\text{A}$

NOTES:

(1) Data per individual LED element

(2) Luminous intensity (ucd) = average light output per segment

(3) B = breakdown

PIN ORIENTATION, SEGMENT IDENTIFICATION, AND PRODUCT MARKING

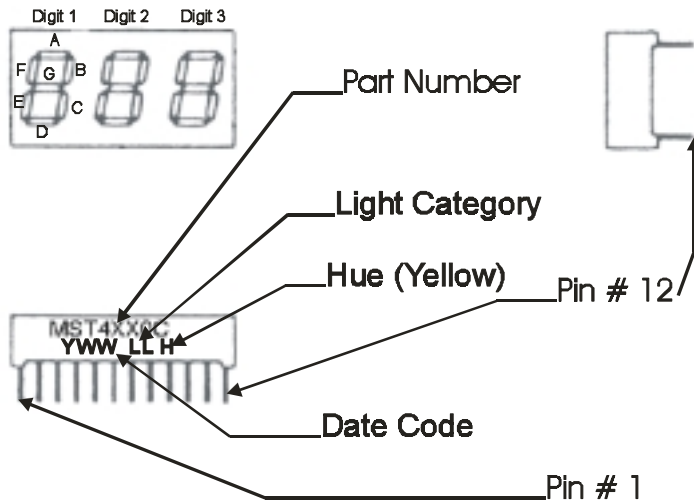

SCHEMATICS

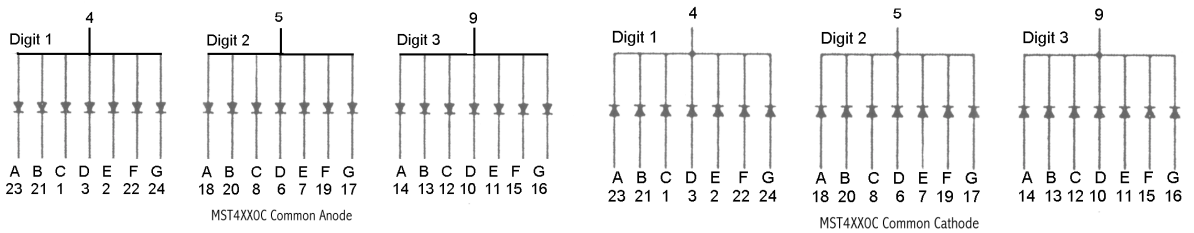

GRAPHICAL DATA Bright Red ($T_A = 25^\circ\text{C}$, unless otherwise specified)

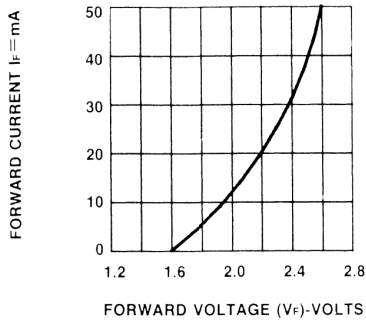

Fig.1 FORWARD CURRENT VS. FORWARD VOLTAGE.

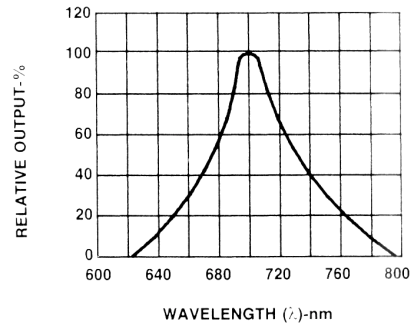

Fig.2 SPECTRAL RESPONSE

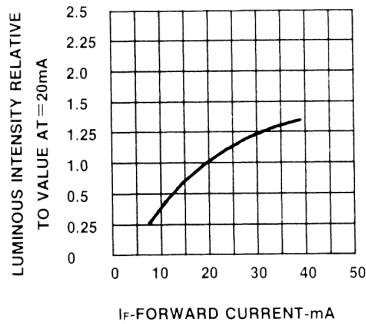

Fig.3 RELATIVE LUMINOUS INTENSITY VS. FORWARD CURRENT

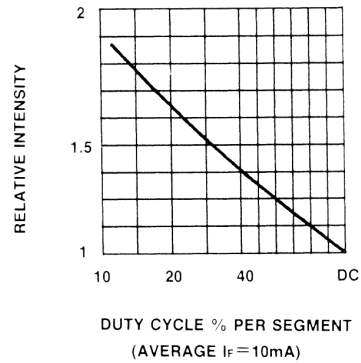

Fig.5 LUMINOUS INTENSITY VS. DUTY CYCLE

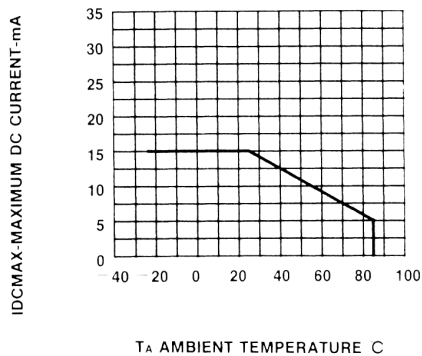

Fig.4 MAXIMUM ALLOWABLE DC CURRENT PER SEGMENT VS. A FUNCTION OF AMBIENT TEMPERATURE.

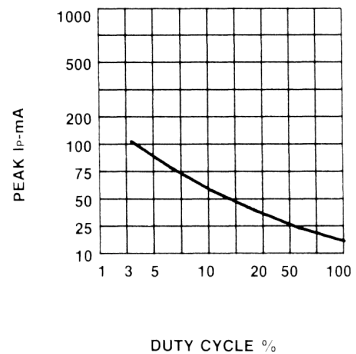

Fig.6 MAX PEAK CURRENT VS. DUTY CYCLE % (REFRESH RATE $f = 1\text{KHz}$)

GRAPHICAL DATA Green ($T_A = 25^\circ\text{C}$, unless otherwise specified)

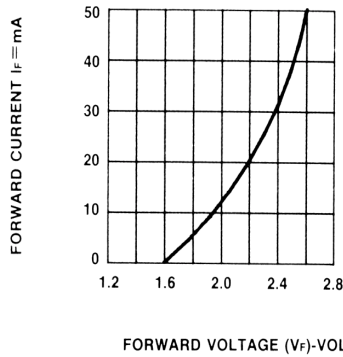

Fig.1 FORWARD CURRENT VS. FORWARD VOLTAGE.

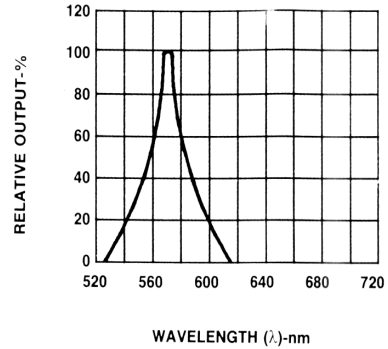

Fig.2 SPECTRAL RESPONSE

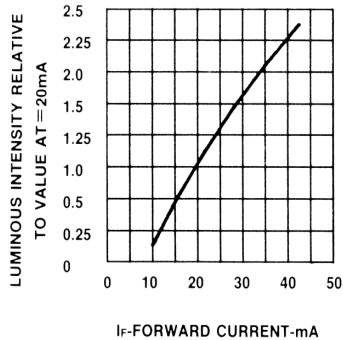

Fig.3 RELATIVE LUMINOUS INTENSITY VS. FORWARD CURRENT

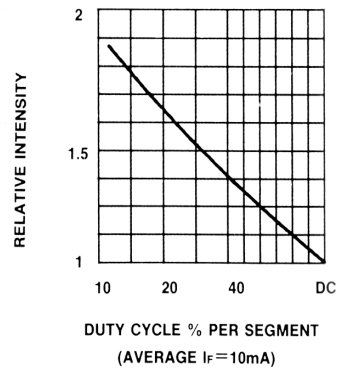

Fig.5 LUMINOUS INTENSITY VS. DUTY CYCLE

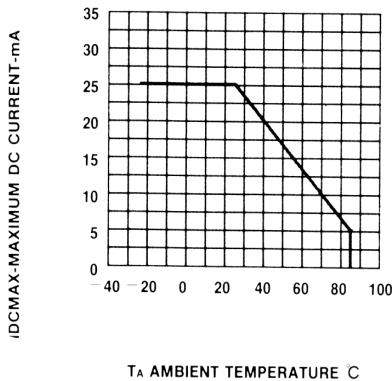

Fig.4 MAXIMUM ALLOWABLE DC CURRENT PER SEGMENT CS. A FUNCTION OF AMBIENT TEMPERATURE.

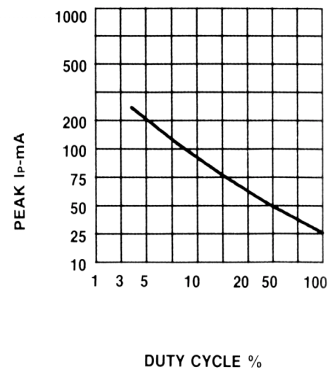

Fig. 6 MAX PEAK CURRENT VS. DUTY CYCLE % (REFRESH RATE $f = 1\text{ KHz}$)

GRAPHICAL DATA High Efficiency Red ($T_A = 25^\circ\text{C}$, unless otherwise specified)

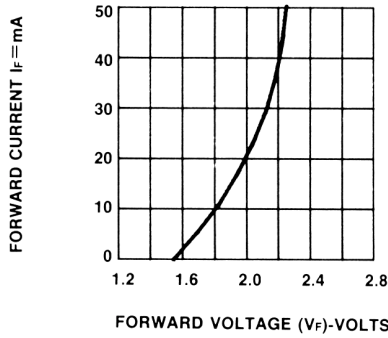

Fig.1 FORWARD CURRENT VS. FORWARD VOLTAGE.

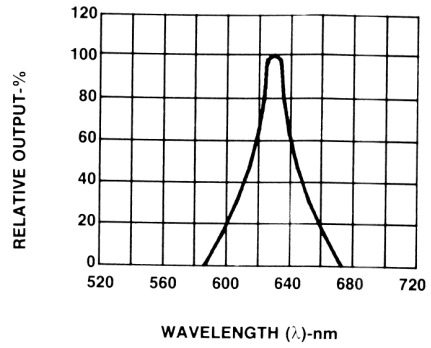

Fig.2 SPECTRAL RESPONSE

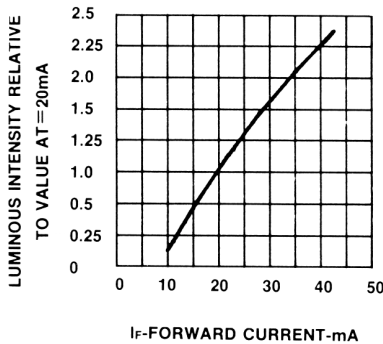

Fig.3 RELATIVE LUMINOUS INTENSITY VS. FORWARD CURRENT

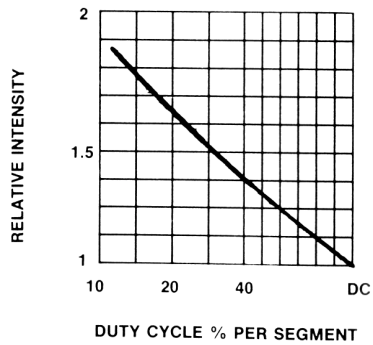

Fig.5 LUMINOUS INTENSITY VS. DUTY CYCLE

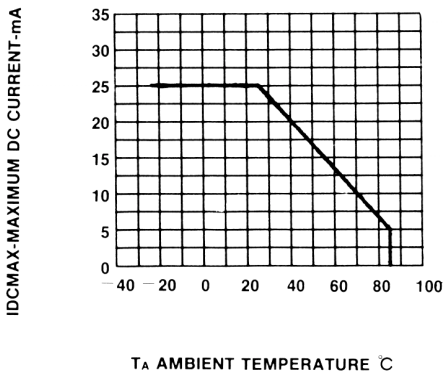

Fig.4 MAXIMUM ALLOWABLE DC CURRENT PER SEGMENT VS. A FUNCTION OF AMBIENT TEMPERATURE.

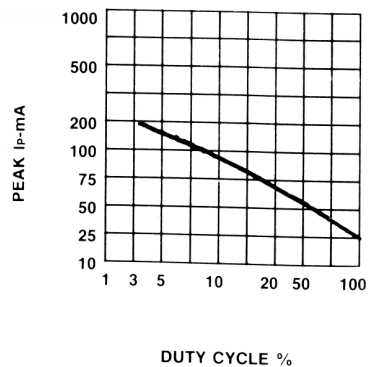

Fig. 6 MAX PEAK CURRENT VS. DUTY CYCLE % (REFRESH RATE $f=1\text{ KHz}$)



10mm (0.400 inch) Three Digit NUMERIC STICK DISPLAY

DISCLAIMER

FAIRCHILD SEMICONDUCTOR RESERVES THE RIGHT TO MAKE CHANGES WITHOUT FURTHER NOTICE TO ANY PRODUCTS HEREIN TO IMPROVE RELIABILITY, FUNCTION OR DESIGN. FAIRCHILD DOES NOT ASSUME ANY LIABILITY ARISING OUT OF THE APPLICATION OR USE OF ANY PRODUCT OR CIRCUIT DESCRIBED HEREIN; NEITHER DOES IT CONVEY ANY LICENSE UNDER ITS PATENT RIGHTS, NOR THE RIGHTS OF OTHERS.

LIFE SUPPORT POLICY

FAIRCHILD'S PRODUCTS ARE NOT AUTHORIZED FOR USE AS CRITICAL COMPONENTS IN LIFE SUPPORT DEVICES OR SYSTEMS WITHOUT THE EXPRESS WRITTEN APPROVAL OF THE PRESIDENT OF FAIRCHILD SEMICONDUCTOR CORPORATION. As used herein:

1. Life support devices or systems are devices or systems which, (a) are intended for surgical implant into the body, or (b) support or sustain life, and (c) whose failure to perform when properly used in accordance with instructions for use provided in the labeling, can be reasonably expected to result in a significant injury of the user.
2. A critical component in any component of a life support device or system whose failure to perform can be reasonably expected to cause the failure of the life support device or system, or to affect its safety or effectiveness.