



**N-Channel Enhancement-Mode  
Vertical DMOS FETs**

**Ordering Information**

BV <sub>DSS</sub> / BV <sub>DGS</sub>	R <sub>DS(ON)</sub> (max)	I <sub>D(ON)</sub> (min)	V <sub>GS(th)</sub> (max)	Order Number / Package	
				TO-92	Die†
60V	3.0Ω	2A	2.0V	TN0106N3	—
100V	3.0Ω	2A	2.0V	TN0110N3	TN0110ND

† MIL visual screening available

**Features**

- Low threshold — 2.0V max.
- High input impedance
- Low input capacitance — 50pF typical
- Fast switching speeds
- Low on resistance
- Free from secondary breakdown
- Low input and output leakage
- Complementary N- and P-channel devices

**Applications**

- Logic level interfaces – ideal for TTL and CMOS
- Solid state relays
- Battery operated systems
- Photo voltaic drives
- Analog switches
- General purpose line drivers
- Telecom switches

**Absolute Maximum Ratings**

Drain-to-Source Voltage	BV <sub>DSS</sub>
Drain-to-Gate Voltage	BV <sub>DGS</sub>
Gate-to-Source Voltage	± 20V
Operating and Storage Temperature	-55°C to +150°C
Soldering Temperature*	300°C

\* Distance of 1.6 mm from case for 10 seconds.

**Low Threshold DMOS Technology**

These low threshold enhancement-mode (normally-off) transistors utilize a vertical DMOS structure and Supertex's well-proven silicon-gate manufacturing process. This combination produces devices with the power handling capabilities of bipolar transistors and with the high input impedance and positive temperature coefficient inherent in MOS devices. Characteristic of all MOS structures, these devices are free from thermal runaway and thermally-induced secondary breakdown.

Supertex's vertical DMOS FETs are ideally suited to a wide range of switching and amplifying applications where very low threshold voltage, high breakdown voltage, high input impedance, low input capacitance, and fast switching speeds are desired.

**Package Options**

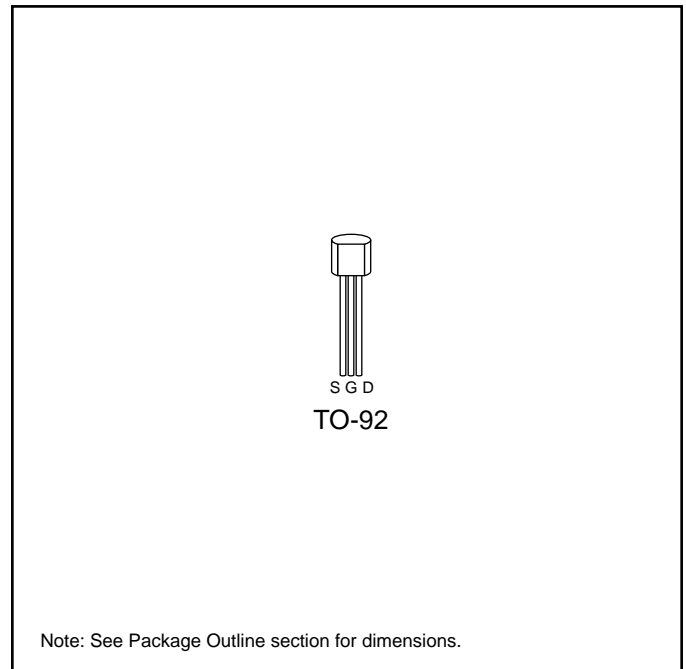

## Thermal Characteristics

Package	$I_D$ (continuous)*	$I_D$ (pulsed)	Power Dissipation @ $T_C = 25^\circ\text{C}$	$\theta_{jc}$ $^\circ\text{C/W}$	$\theta_{ja}$ $^\circ\text{C/W}$	$I_{DR}^*$	$I_{DRM}$
TO-92	0.5A	2.0A	1.0W	125	170	0.5A	2.0A

\*  $I_D$  (continuous) is limited by max rated  $T_J$ .

## Electrical Characteristics (@ $25^\circ\text{C}$ unless otherwise specified)

Symbol	Parameter	Min	Typ	Max	Unit	Conditions
$BV_{DSS}$	Drain-to-Source Breakdown Voltage	TN0110	100			$V$ $I_D = 1\text{mA}, V_{GS} = 0\text{V}$
		TN0106	60			
$V_{GS(th)}$	Gate Threshold Voltage	0.6		2.0	$V$	$V_{GS} = V_{DS}, I_D = 0.5\text{mA}$
$\Delta V_{GS(th)}$	Change in $V_{GS(th)}$ with Temperature		-3.2	-5.0	$\text{mV}/^\circ\text{C}$	$V_{GS} = V_{DS}, I_D = 1.0\text{mA}$
$I_{GSS}$	Gate Body Leakage			100	$\text{nA}$	$V_{GS} = \pm 20\text{V}, V_{DS} = 0\text{V}$
$I_{DSS}$	Zero Gate Voltage Drain Current			10	$\mu\text{A}$	$V_{GS} = 0\text{V}, V_{DS} = \text{Max Rating}$
				500		$V_{GS} = 0\text{V}, V_{DS} = 0.8 \text{ Max Rating}$ $T_A = 125^\circ\text{C}$
$I_{D(ON)}$	ON-State Drain Current	0.75	1.4		$\text{A}$	$V_{GS} = 5\text{V}, V_{DS} = 25\text{V}$
		2.0	3.4			$V_{GS} = 10\text{V}, V_{DS} = 25\text{V}$
$R_{DS(ON)}$	Static Drain-to-Source ON-State Resistance		2.0	4.5	$\Omega$	$V_{GS} = 4.5\text{V}, I_D = 250\text{mA}$
			1.6	3.0		$V_{GS} = 10\text{V}, I_D = 500\text{mA}$
$\Delta R_{DS(ON)}$	Change in $R_{DS(ON)}$ with Temperature		0.6	1.1	$\%/^\circ\text{C}$	$I_D = 0.5\text{A}, V_{GS} = 10\text{V}$
$G_{FS}$	Forward Transconductance	225	400		$\text{m}\Omega$	$V_{DS} = 25\text{V}, I_D = 500\text{mA}$
$C_{ISS}$	Input Capacitance		50	60	$\text{pF}$	$V_{GS} = 0\text{V}, V_{DS} = 25\text{V}$ $f = 1\text{MHz}$
$C_{OSS}$	Common Source Output Capacitance		25	35		
$C_{RSS}$	Reverse Transfer Capacitance		4.0	8.0		
$t_{d(ON)}$	Turn-ON Delay Time		2.0	5.0	$\text{ns}$	$V_{DD} = 25\text{V}$ $I_D = 1.0\text{A}$ $R_{GEN} = 25\Omega$
$t_r$	Rise Time		3.0	5.0		
$t_{d(OFF)}$	Turn-OFF Delay Time		6.0	7.0		
$t_f$	Fall Time		3.0	6.0		
$V_{SD}$	Diode Forward Voltage Drop		1.0	1.5	$\text{V}$	$I_{SD} = 0.5\text{A}, V_{GS} = 0\text{V}$
$t_{rr}$	Reverse Recovery Time		400		$\text{ns}$	$I_{SD} = 0.5\text{A}, V_{GS} = 0\text{V}$

### Notes:

- All D.C. parameters 100% tested at  $25^\circ\text{C}$  unless otherwise stated. (Pulse test:  $300\mu\text{s}$  pulse, 2% duty cycle.)
- All A.C. parameters sample tested.

## Switching Waveforms and Test Circuit

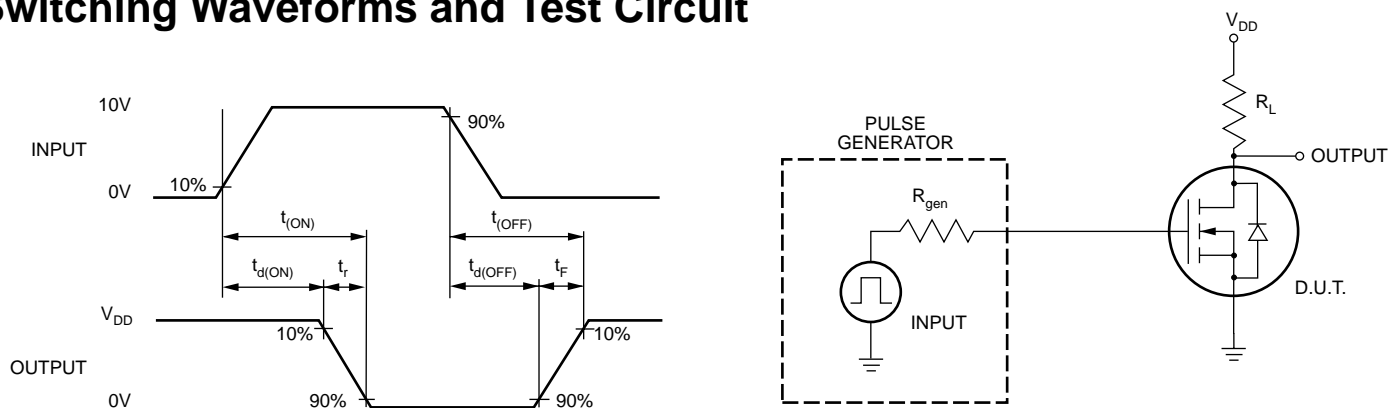

# Typical Performance Curves

Output Characteristics

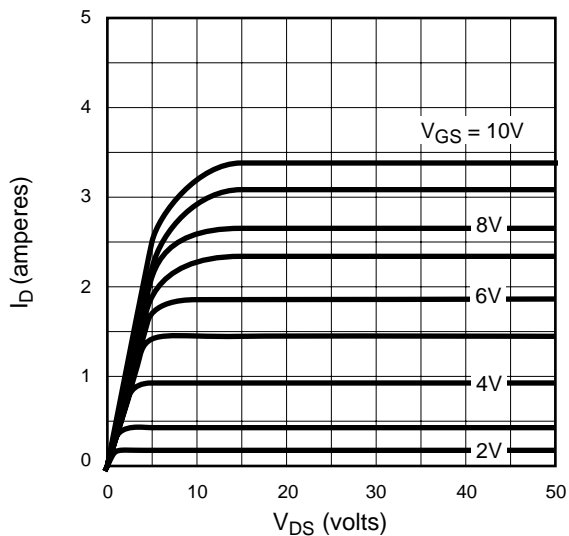

Saturation Characteristics

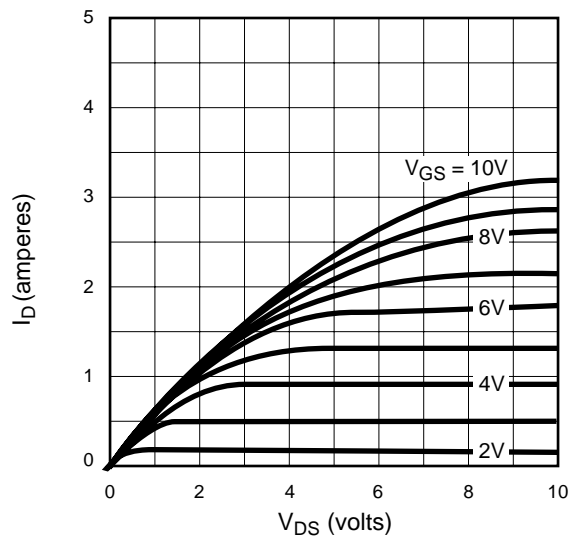

Transconductance vs. Drain Current

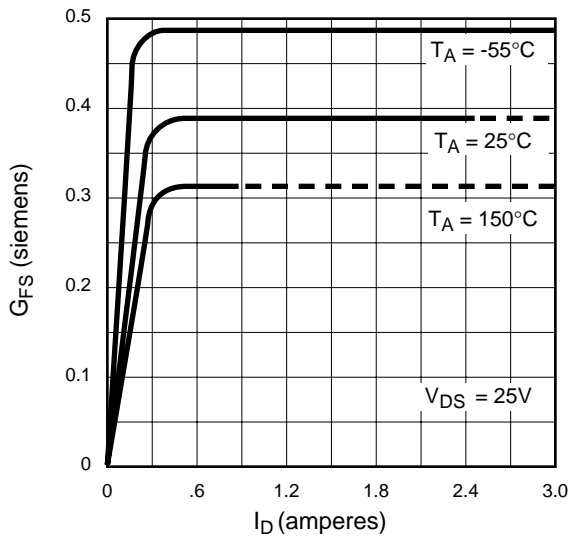

Power Dissipation vs. Case Temperature

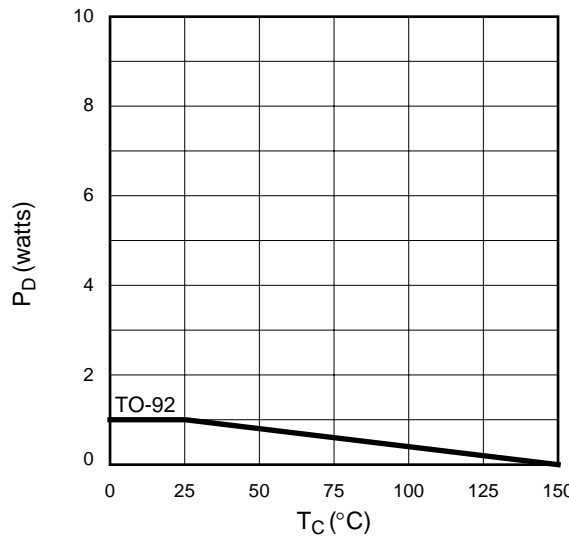

Maximum Rated Safe Operating Area

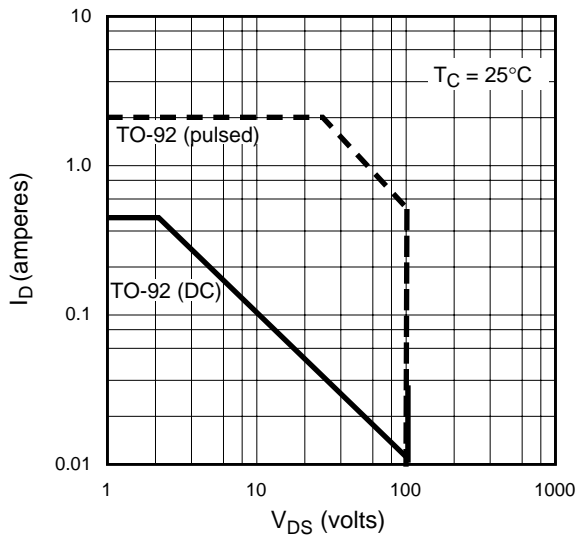

Thermal Response Characteristics

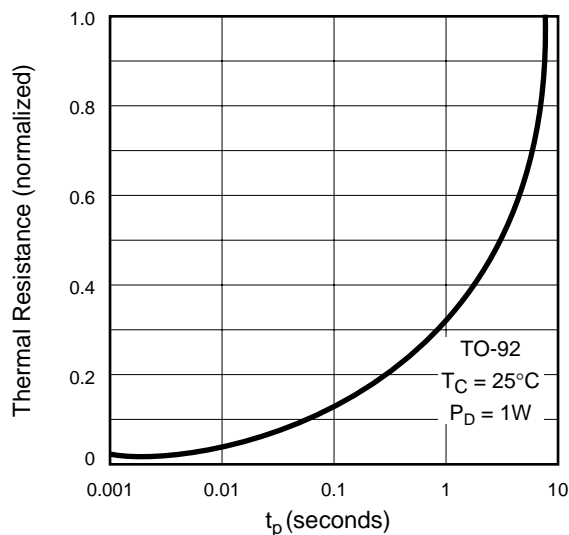

# Typical Performance Curves

BV<sub>DSS</sub> Variation with Temperature

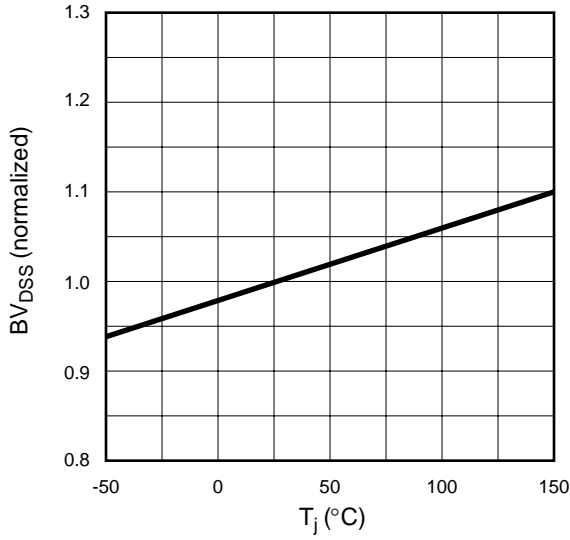

On-Resistance vs. Drain Current

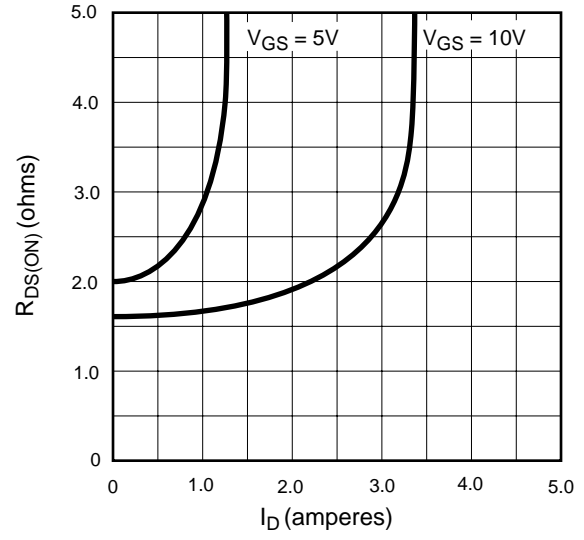

Transfer Characteristics

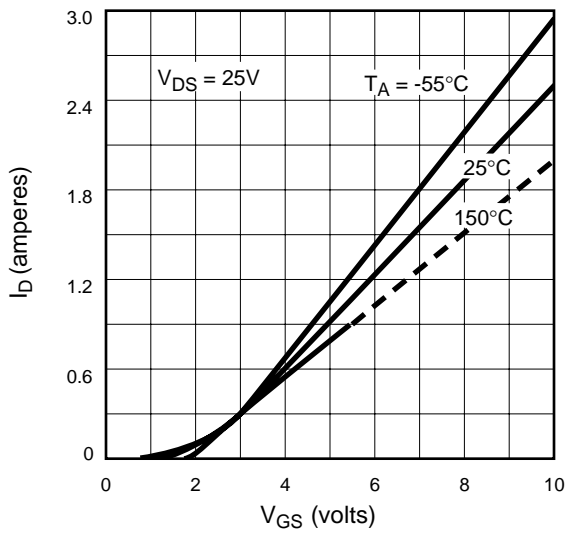

V<sub>(th)</sub> and R<sub>DS</sub> Variation with Temperature

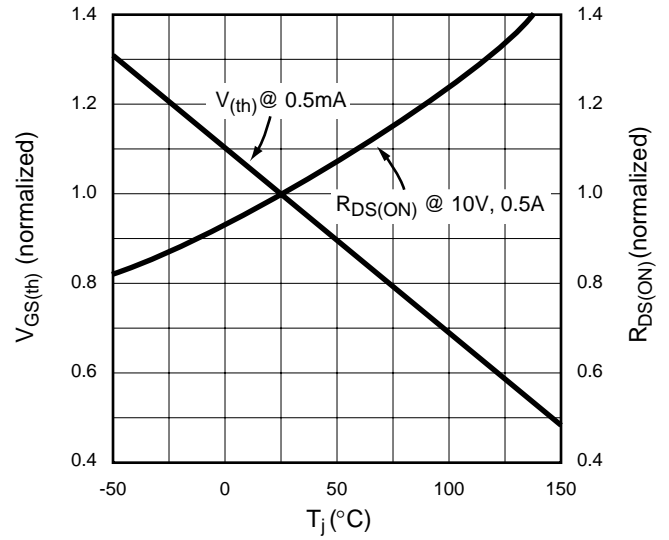

Capacitance vs. Drain-to-Source Voltage

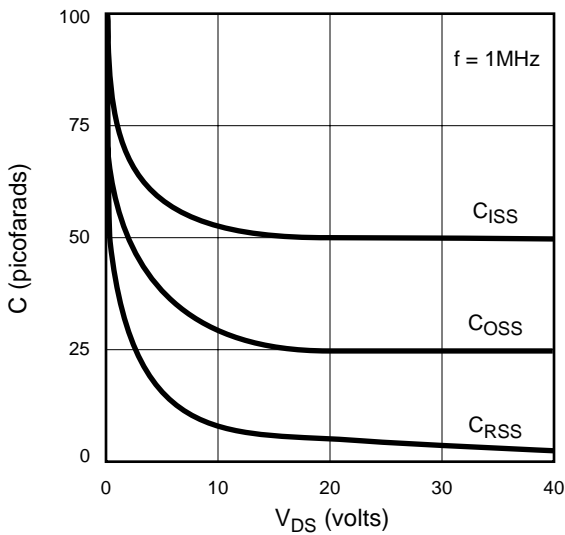

Gate Drive Dynamic Characteristics

