

TOSHIBA MOS MEMORY PRODUCTS

8,192 WORD × 8 BIT STATIC RAM TMM2064P-10, TMM2064P-12
N-CHANNEL SILICON GATE MOS TMM2064P-15

DESCRIPTION

The TMM2064P is a 65,536 bits high speed and low power static random access memory organized as 8,192 words by 8 bits and operates from a single 5V supply. Toshiba's high performance device technology provides both high speed and low power features with a maximum access time of 100ns/120ns/150ns and maximum operating current of 80mA. When \overline{CS}_1 is a logical high or \overline{CS}_2 is a logical

low, the device is placed in a low power standby mode in which maximum standby current is 10mA. Thus the TMM2064P is most suitable for use in microcomputer peripheral memory where the low power applications are required. The TMM2064P is fabricated with ion implanted N channel silicon gate MOS technology for high performance and high reliability.

FEATURES

● Access Time and Current

Part Number	Parameter	Access Time (Max.)	Operating Current (Max.)	Standby Current (Max.)
TMM2064P-10		100ns	80mA	10mA
TMM2064P-12		120ns	80mA	10mA
TMM2064P-15		150ns	80mA	10mA

- Single 5V Power Supply
- Fully Static Operation
- Power Down Feature : \overline{CS}_1 \overline{CS}_2
- Output Buffer Control : \overline{OE}
- Three State Outputs
- All Inputs and Outputs : Directly TTL Compatible
- Inputs Protected : All inputs have protection against static charge.

PIN CONNECTION

N. C.	1	28	V _{CC}
A ₁₂	2	27	\overline{WE}
A ₇	3	26	\overline{CS}_2
A ₆	4	25	A ₈
A ₅	5	24	A ₉
A ₄	6	23	A ₁₁
A ₃	7	22	\overline{OE}
A ₂	8	21	A ₁₀
A ₁	9	20	\overline{CS}_1
A ₀	10	19	I/O ₈
I/O ₁	11	18	I/O ₇
I/O ₂	12	17	I/O ₆
I/O ₃	13	16	I/O ₅
GND	14	15	I/O ₄

PIN NAMES

SYMBOL	NAME
A ₀ ~A ₄	Column Address Inputs
A ₅ ~A ₁₂	Row Address Inputs
\overline{CS}_1 , \overline{CS}_2	Chip Select Inputs
\overline{WE}	Write Enable Input
I/O ₁ ~I/O ₈	Data Input/Output
\overline{OE}	Output Enable Input
V _{CC}	Power (5V)
GND	Ground
N. C.	No Connection

BLOCK DIAGRAM

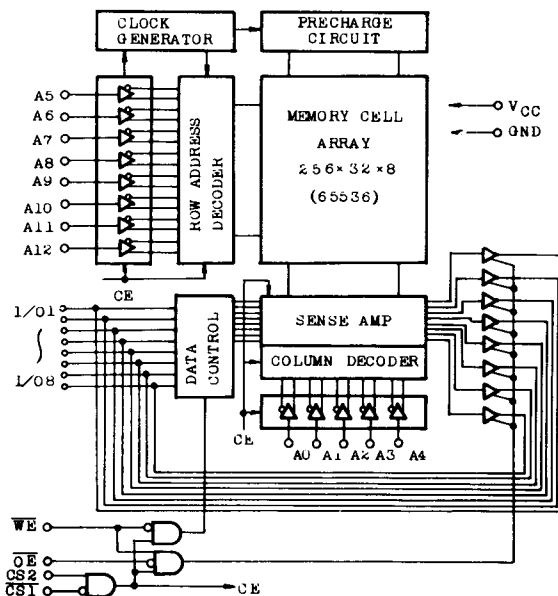

TMM2064P-10, TMM2064P-12 TMM2064P-15

MAXIMUM RATINGS

SYMBOL	ITEM	RATING	UNIT
V _{CC}	Power Supply Voltage	-0.5~7.0	V
V _{IN} , V _{OUT}	Input/Output Voltage	-0.5*~7.0	V
T _{OPR}	Operating Temperature	0~70	°C
T _{STG}	Storage Temperature	-55~150	°C
T _{SOLDER}	Soldering Temperature · Time	260 · 10	°C·sec
P _D	Power Dissipation (Ta = 70°C)	1.0	W

* -3.0V at Pulse width 50ns

D. C. RECOMMENDED OPERATING CONDITIONS (Ta=0~70°C)

SYMBOL	PARAMETER	MIN.	TYP.	MAX.	UNIT
V _{IH}	Input High Voltage	2.0	—	V _{CC} +1.0	V
V _{IL}	Input Low Voltage	-0.5**	—	0.8	V
V _{CC}	Supply Voltage	4.5	5.0	5.5	V

** -3.0V at Pulse width 50ns

D. C. CHARACTERISTICS (Ta=0~70°C, V_{CC}=5.0V±10%)

SYMBOL	PARAMETER	CONDITIONS	MIN.	TYP.	MAX.	UNIT
I _{IL}	Input Leakage Current	V _{IN} =0V~5.5V	-10	—	10	μA
V _{OH}	Output High Voltage	I _{OUT} =-1.0mA	2.4	—	—	V
V _{OL}	Output Low Voltage	I _{OUT} =2.1mA	—	—	0.4	V
I _{LO}	Output Leakage Current	CS ₁ =V _{IH} or CS ₂ =V _{IL} or WE=V _{IL} or OE=V _{IH} , V _{OUT} =0V~5.5V	-10	—	10	μA
I _{SBP}	Peak Power-on Current	CS ₁ =V _{CC} , CS ₂ =0V I _{OUT} =0mA	—	—	20	mA
I _{SB}	Standby Current	CS ₁ =V _{IH} or CS ₂ =V _{IL} , I _{OUT} =0mA	—	—	10	mA
I _{CC}	Operating Current	CS ₁ =V _{IL} , CS ₂ =V _{IH} , I _{OUT} =0mA	—	—	80	mA

CAPACITANCE*** (Ta=25°C, f=1.0 MHz)

SYMBOL	PARAMETER	CONDITIONS	MAX.	UNIT
C _{IN}	Input Capacitance	V _{IN} =0V	5	pF
C _{OUT}	Output Capacitance	V _{IN} =0V	10	pF

*** Note : This parameter is periodically sampled and is not 100% tested.

TMM2064P-10, TMM2064P-12 TMM2064P-15

A. C. CHARACTERISTICS (Ta=0~70°C, Vcc=5V±10%)

Read Cycle

SYMBOL	PARAMETER	TMM2064P-10		TMM2064P-12		TMM2064P-15		UNIT
		MIN.	MAX.	MIN.	MAX.	MIN.	MAX.	
t _{RC}	Read Cycle Time	100	—	120	—	150	—	ns
t _{ACC}	Address Access Time	—	100	—	120	—	150	
t _{CO1}	\overline{CS}_1 Access Time	—	100	—	120	—	150	
t _{CO2}	\overline{CS}_2 Access Time	—	100	—	120	—	150	
t _{OE}	\overline{OE} Access Time	—	40	—	50	—	60	
t _{OH}	Output Data Hold Time from Address Change	10	—	10	—	10	—	
t _{CLZ}	\overline{CS}_1 or \overline{CS}_2 to Output in Low-Z	10	—	10	—	10	—	
t _{CHZ}	\overline{CS}_1 or \overline{CS}_2 to Output in High-Z	—	40	—	40	—	55	
t _{OLZ}	\overline{OE} to Output in Low-Z	5	—	5	—	5	—	
t _{OHZ}	\overline{OE} to Output in High-Z	—	35	—	35	—	50	
t _{PU}	Chip Selection to Power Up Time	0	—	0	—	0	—	
t _{PD}	Chip Deselection to Power Down Time	—	50	—	60	—	60	

Write Cycle

SYMBOL	PARAMETER	TMM2064P-10		TMM2064P-12		TMM2064P-15		UNIT
		MIN.	MAX.	MIN.	MAX.	MIN.	MAX.	
t _{WC}	Write Cycle Time	100	—	120	—	150	—	ns
t _{CW}	Chip Selection to End of Write	80	—	100	—	120	—	
t _{AS}	Address Set Up Time	10	—	10	—	10	—	
t _{WP}	Write Pulse Width	70	—	85	—	100	—	
t _{WR}	Write Recovery Time	0	—	0	—	0	—	
t _{DS}	Data Set Up Time	40	—	50	—	60	—	
t _{DH}	Data Hold Time	0	—	0	—	0	—	
t _{WLZ}	\overline{WE} to Output in Low-Z	5	—	5	—	5	—	
t _{WHZ}	\overline{WE} to Output in High-Z	—	30	—	35	—	40	

A. C. TEST CONDITIONS

Input Pulse Levels	V _{IH} =2.2V, V _{IL} =0.6V
Input Rise and Fall Time	10ns
Input and Output Reference Levels	1.5V
Output Load	1 TTL Gate & C _L =100pF

TMM2064P-10, TMM2064P-12 TMM2064P-15

TIMING WAVEFORMS

● READ CYCLE (1)

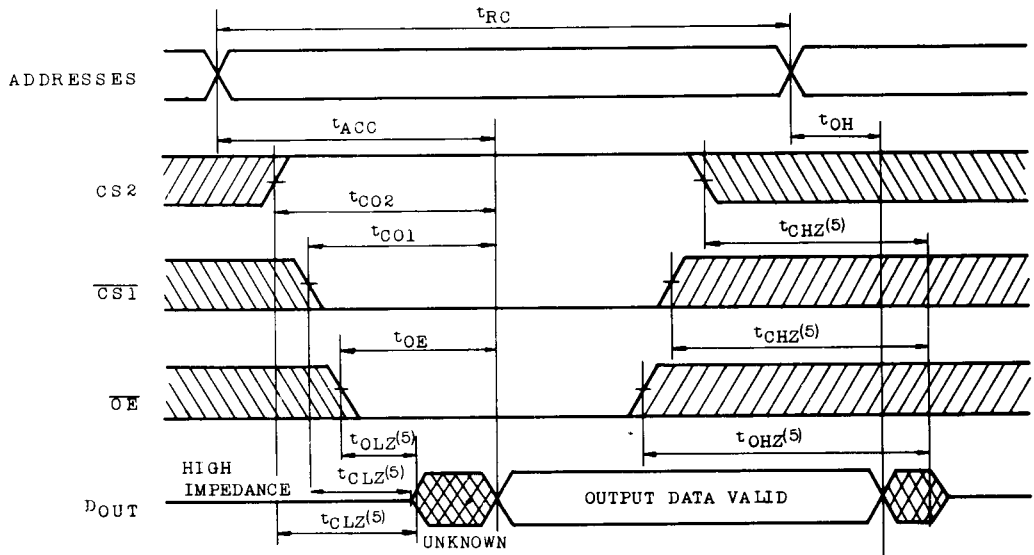

● WRITE CYCLE 1 (4) (\overline{WE} Controlled Write)

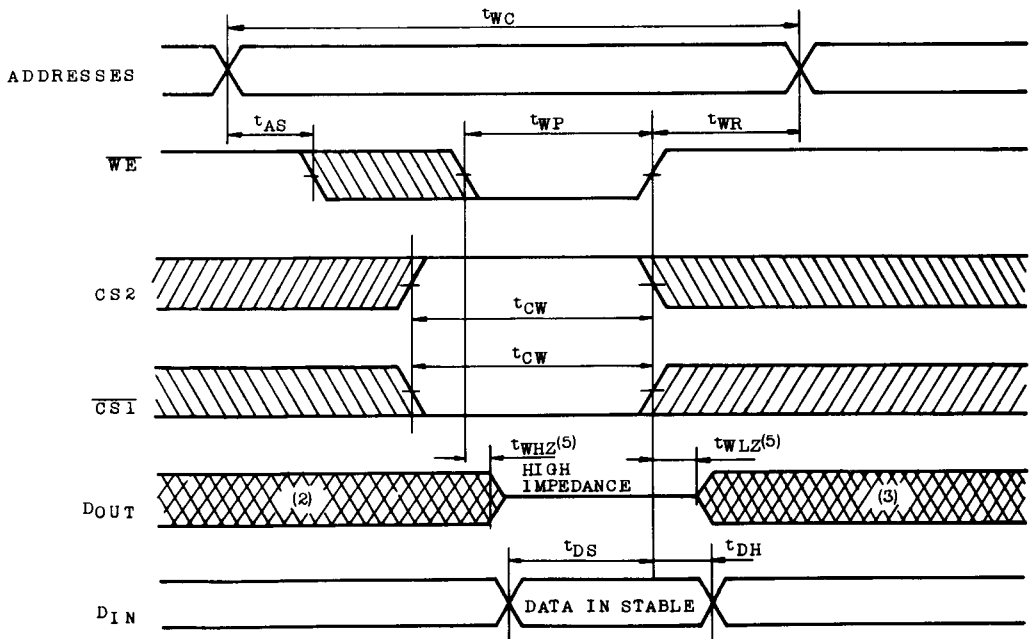

TMM2064P-10, TMM2064P-12 TMM2064P-15

● WRITE CYCLE 2 (4) ($\overline{CS1}$ Controlled Write)

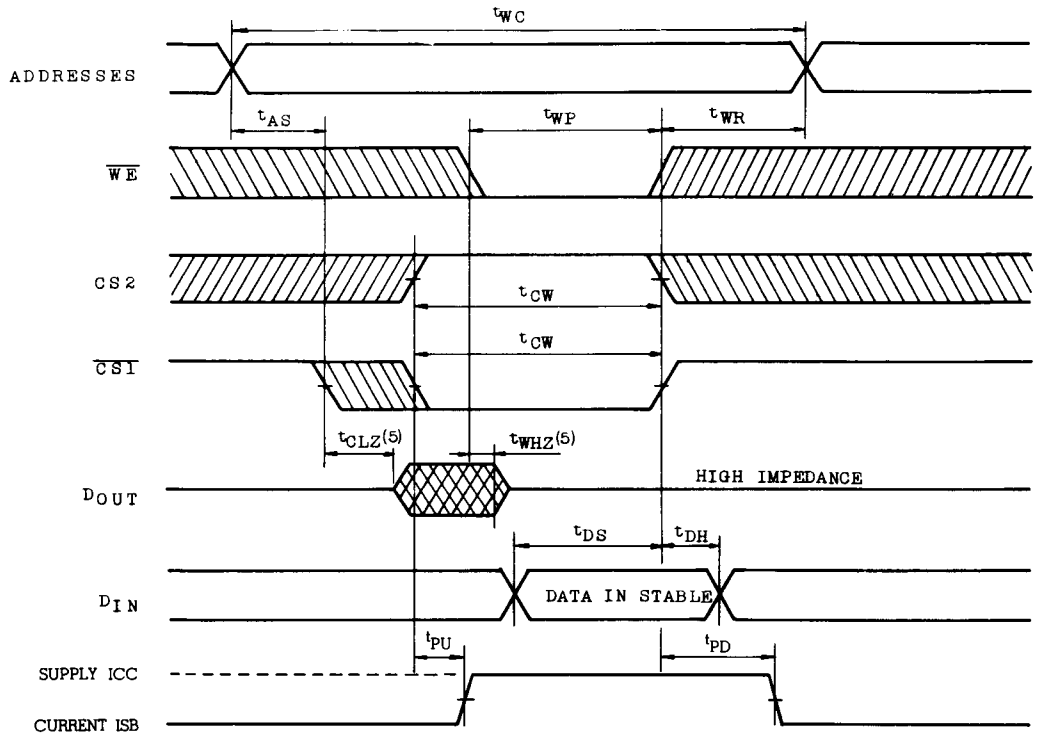

● WRITE CYCLE 3 (4) ($\overline{CS2}$ Controlled Write)

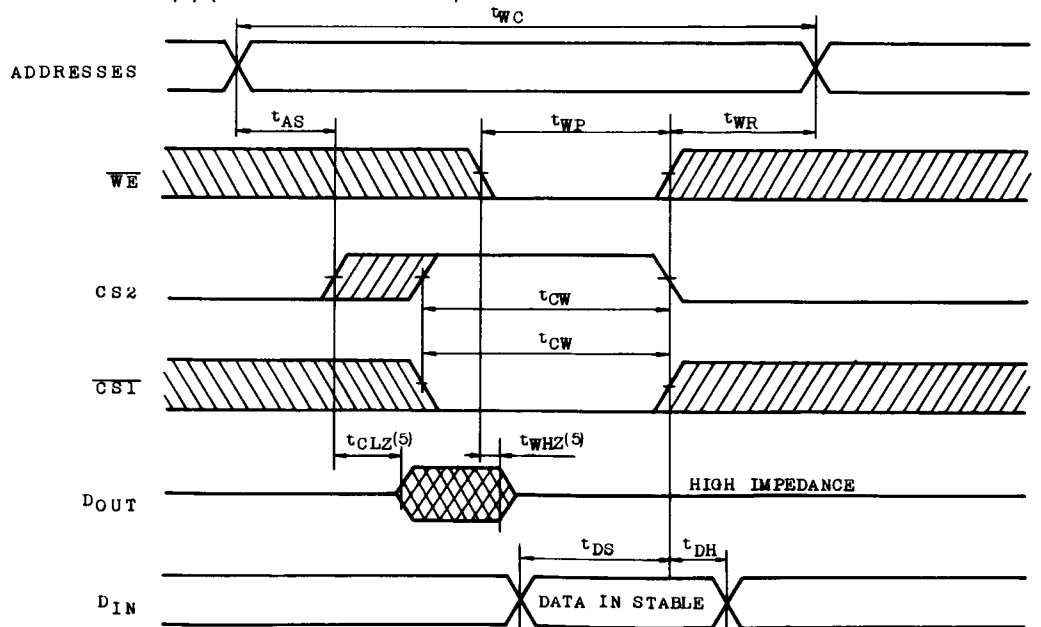

TMM2064P-10, TMM2064P-12 TMM2064P-15

Note :

1. \overline{WE} is High for Read Cycle.
2. Assuming that $\overline{CS1}$ Low transition or $\overline{CS2}$ High transition occurs coincident with or after \overline{WE} Low transition, Outputs remain in a high impedance state.
3. Assuming that $\overline{CS1}$ High transition or $\overline{CS2}$ Low transition occurs coincident with or prior to \overline{WE} High transition, Outputs remain in a high impedance state.
4. Assuming that \overline{OE} is High for Write Cycle, Outputs are in high impedance state during this period.
5. These parameters are specified as follows and measured by using the load shown in Fig. 1.
 - (A) t_{CLZ} , t_{OLZ} , t_{WLZ}Output Enable Time
 - (B) t_{CHZ} , t_{OHZ} , t_{WHZ}Output Disable Time

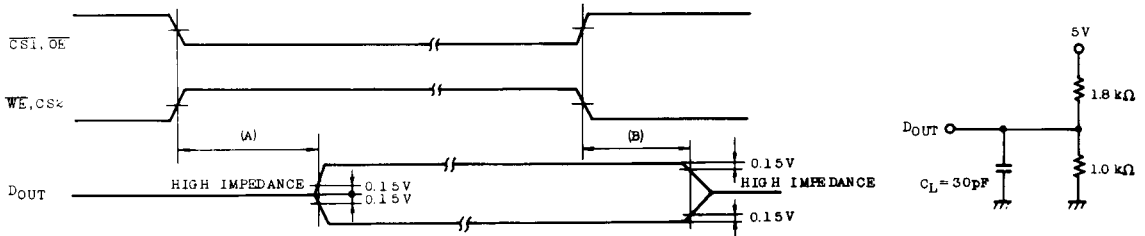
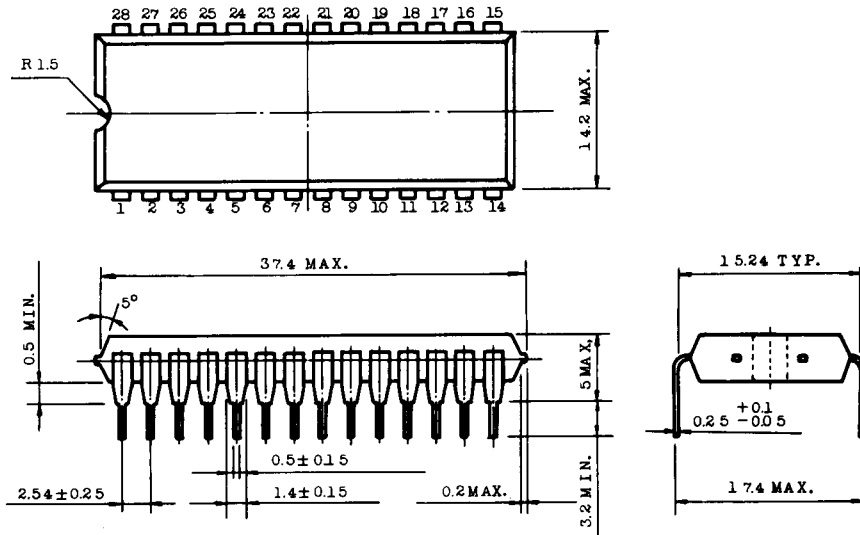

Fig. 1 Output load condition for enable disable time measurement.

OUTLINE DRAWINGS

Unit: mm



NOTES : Each lead pitch is 2.54mm. All leads are located within 0.25mm of their true longitudinal position with respect to No. 1 and No. 28 leads.

Note : Toshiba does not assume any responsibility for use of any circuitry described ; no circuit patent licenses are implied, and Toshiba reserves the right, at any time without notice, to change said circuitry.

©Aug., 1985 Toshiba Corporation