

# MAXIM

## 1µA SOT23 Precision Shunt Voltage Reference

MAX6006-MAX6009

### General Description

The MAX6006–MAX6009 ultra-low-power shunt references are ideal for space-critical and low-power applications. They are offered in 3-pin SOT23 packages, and the minimum operating current is guaranteed to be <1µA. The devices feature low temperature coefficients of <30ppm/°C and initial accuracy of better than 0.2%.

Available in +1.25V, +2.048V, +2.5V, and 3V output voltages, the MAX6006–MAX6009 have references of +1.25V, +2.048V, +2.5V, and +3.0V, respectively. The devices can be used as lower-power, higher-precision upgrades to the ICL8069, LM385, LT1004, and LM4040 references. The MAX6006–MAX6009 are available in two grades: A and B. The A grade features a temperature coefficient of 30ppm/°C over the extended temperature range of -40°C to +85°C, with an initial accuracy of 0.2%. Grade B features a temperature coefficient of 75ppm/°C with an initial accuracy of 0.5%. MAX6006 in +1.25V and MAX6008 in +2.5V are offered in 8-pin SOIC packages, as plug in upgrades for LT1004 and LM285.

### Applications

- Battery-Powered Equipment
- Portable Meters
- Precision Regulators
- A/D and D/A Converters

### Features

- ◆ Ultra-Low Operating Current: Guaranteed <1µA
- ◆ Small 3-Pin SOT23 Package
- ◆ Initial Voltage Accuracy: 0.2%
- ◆ Temperature Coefficient: 30ppm/°C max
- ◆ Temperature Range: -40°C to +85°C
- ◆ Factory-Trimmed Output Voltages: +1.25V, +2.048V, +2.5V, +3.0V
- ◆ Wide Operating Range: 1µA to 2mA

### Selector Guide

PART	OUTPUT VOLTAGE (V)	INITIAL ACCURACY (%)	TEMPERATURE COEFFICIENT (ppm/°C)
MAX6006A	1.25	0.2	30
MAX6006B	1.25	0.5	75
MAX6007A	2.048	0.2	30
MAX6007B	2.048	0.5	75
MAX6008A	2.5	0.2	30
MAX6008B	2.5	0.5	75
MAX6009A	3.0	0.2	30
MAX6009B	3.0	0.5	75

Ordering Information appears at end of data sheet

### Typical Operating Circuit

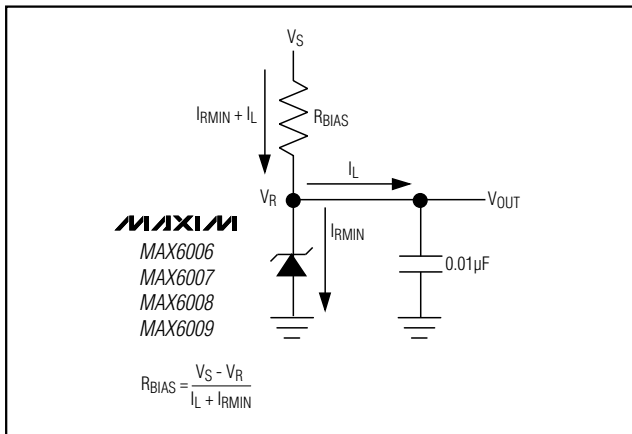

### Pin Configuration

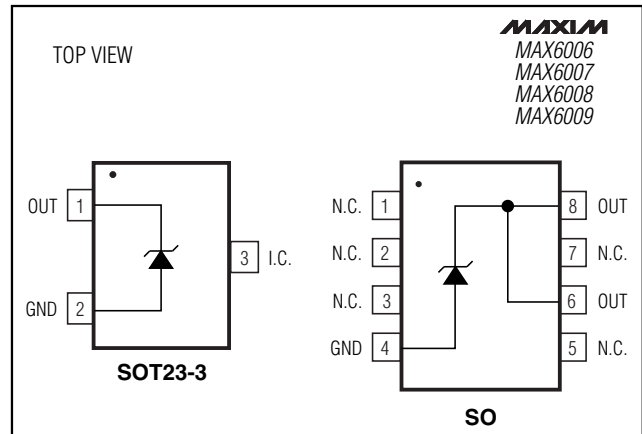

# 1 $\mu$ A SOT23 Precision Shunt Voltage Reference

## ABSOLUTE MAXIMUM RATINGS

Operating Current (OUT to GND) .....	20mA	Operating Temperature Range .....	-40°C to +85°C
Forward Current (GND to OUT) .....	20mA	Storage Temperature Range .....	-65°C to +150°C
Continuous Power Dissipation (T <sub>A</sub> = +70°C)		Lead Temperature (soldering, 10s) .....	+300°C
3-Pin SOT23 (derate 4mW/°C above +70°C) .....	320mW		
8-Pin SO (derate 5.48mW/°C above +70°C) .....	471mW		

Stresses beyond those listed under "Absolute Maximum Ratings" may cause permanent damage to the device. These are stress ratings only, and functional operation of the device at these or any other conditions beyond those indicated in the operational sections of the specifications is not implied. Exposure to absolute maximum rating conditions for extended periods may affect device reliability.

## ELECTRICAL CHARACTERISTICS—MAX6006

(T<sub>A</sub> = -40°C to +85°C, unless otherwise noted. Typical values are at T<sub>A</sub> = +25°C.) (Note 1)

PARAMETER	SYMBOL	CONDITIONS	MIN	TYP	MAX	UNITS	
Reverse Breakdown Voltage	V <sub>R</sub>	T <sub>A</sub> = +25°C, I <sub>R</sub> = 1.2 $\mu$ A	MAX6006A (0.2%)	1.2475	1.2500	1.2525	V
			MAX6006B (0.5%)	1.2438	1.2500	1.2563	
Minimum Operating Current	I <sub>RMIN</sub>	V <sub>R</sub> change <0.2% from V <sub>R</sub> at I <sub>R</sub> = 1.2 $\mu$ A		0.5	1.0	$\mu$ A	
Reverse Breakdown Change with Current		I <sub>R</sub> = 1.2 $\mu$ A to 200 $\mu$ A			1.0	mV	
		I <sub>R</sub> = 200 $\mu$ A to 2mA			2.0		
Reverse Dynamic Impedance		I <sub>R</sub> = 1.2 $\mu$ A to 2mA (Note 2)			1.5	$\Omega$	
Low-Frequency Noise		I <sub>R</sub> = 1.2 $\mu$ A, f = 0.1Hz to 10Hz		30		$\mu$ V <sub>p-p</sub>	
Temperature Coefficient (Note 3)	TC	I <sub>R</sub> = 1.2 $\mu$ A	MAX6006A		30	ppm/°C	
			MAX6006B		75		
Long-Term Drift		1000h at T <sub>A</sub> = +25°C		150		ppm	
Thermal Hysteresis (Note 4)				200		ppm	

# 1 $\mu$ A SOT23 Precision Shunt Voltage Reference

MAX6006-MAX6009

## ELECTRICAL CHARACTERISTICS—MAX6007

( $T_A = -40^{\circ}\text{C}$  to  $+85^{\circ}\text{C}$ , unless otherwise noted. Typical values are at  $T_A = +25^{\circ}\text{C}$ .) (Note 1)

PARAMETER	SYMBOL	CONDITIONS	MIN	TYP	MAX	UNITS	
Reverse Breakdown Voltage	$V_R$	$T_A = +25^{\circ}\text{C}$ , $I_R = 1.2\mu\text{A}$	MAX6007A (0.2%)	2.0439	2.048	2.0521	V
			MAX6007B (0.5%)	2.0378	2.048	2.0582	
Minimum Operating Current	$I_{RMIN}$	$V_R$ change $<0.2\%$ from $V_R$ at $I_R = 1.2\mu\text{A}$		0.5	1.0	$\mu\text{A}$	
Reverse Breakdown Change with Current		$I_R = 1.2\mu\text{A}$ to $200\mu\text{A}$			1.3	mV	
		$I_R = 200\mu\text{A}$ to $2\text{mA}$			2.3		
Reverse Dynamic Impedance		$I_R = 1.2\mu\text{A}$ to $2\text{mA}$ (Note 2)			1.8	$\Omega$	
Low-Frequency Noise		$I_R = 1.2\mu\text{A}$ , $f = 0.1\text{Hz}$ to $10\text{Hz}$		50		$\mu\text{V}_{p-p}$	
Temperature Coefficient (Note 3)	TC	$I_R = 1.2\mu\text{A}$	MAX6007A		30	ppm/ $^{\circ}\text{C}$	
			MAX6007B		75		
Long-Term Drift		1000h at $T_A = +25^{\circ}\text{C}$		150		ppm	
Thermal Hysteresis (Note 4)				200		ppm	

## ELECTRICAL CHARACTERISTICS—MAX6008

( $T_A = -40^{\circ}\text{C}$  to  $+85^{\circ}\text{C}$ , unless otherwise noted. Typical values are at  $T_A = +25^{\circ}\text{C}$ .) (Note 1)

PARAMETER	SYMBOL	CONDITIONS	MIN	TYP	MAX	UNITS	
Reverse Breakdown Voltage	$V_R$	$T_A = +25^{\circ}\text{C}$ , $I_R = 1.2\mu\text{A}$	MAX6008A (0.2%)	2.4950	2.5000	2.5050	V
			MAX6008B (0.5%)	2.4875	2.5000	2.5125	
Minimum Operating Current	$I_{RMIN}$	$V_R$ change $<0.2\%$ from $V_R$ at $I_R = 1.2\mu\text{A}$		0.5	1.0	$\mu\text{A}$	
Reverse Breakdown Change with Current		$I_R = 1.2\mu\text{A}$ to $200\mu\text{A}$			1.5	mV	
		$I_R = 200\mu\text{A}$ to $2\text{mA}$			2.5		
Reverse Dynamic Impedance		$I_R = 1.2\mu\text{A}$ to $2\text{mA}$ (Note 2)			2	$\Omega$	
Low-Frequency Noise		$I_R = 1.2\mu\text{A}$ , $f = 0.1\text{Hz}$ to $10\text{Hz}$		60		$\mu\text{V}_{p-p}$	
Temperature Coefficient (Note 3)	TC	$I_R = 1.2\mu\text{A}$	MAX6008A		30	ppm/ $^{\circ}\text{C}$	
			MAX6008B		75		
Long-Term Drift		1000h at $T_A = +25^{\circ}\text{C}$		150		ppm	
Thermal Hysteresis (Note 4)				200		ppm	

# 1μA SOT23 Precision Shunt Voltage Reference

## ELECTRICAL CHARACTERISTICS—MAX6009

( $T_A = -40^\circ\text{C}$  to  $+85^\circ\text{C}$ , unless otherwise noted. Typical values are at  $T_A = +25^\circ\text{C}$ .) (Note 1)

PARAMETER	SYMBOL	CONDITIONS	MIN	TYP	MAX	UNITS	
Reverse Breakdown Voltage	$V_R$	$T_A = +25^\circ\text{C}$ , $I_R = 1.2\mu\text{A}$	MAX6009A (0.2%)	2.9940	3.000	3.0060	V
			MAX6009B (0.5%)	2.9850	3.000	3.0150	
Minimum Operating Current	$I_{RMIN}$	$V_R$ change $<0.2\%$ from $V_R$ at $I_R = 1.2\mu\text{A}$		0.5	1.0	$\mu\text{A}$	
Reverse Breakdown Change with Current		$I_R = 1.2\mu\text{A}$ to $200\mu\text{A}$			1.7	mV	
		$I_R = 200\mu\text{A}$ to $2\text{mA}$			2.7		
Reverse Dynamic Impedance		$I_R = 1.2\mu\text{A}$ to $2\text{mA}$ (Note 2)			2.2	$\Omega$	
Low-Frequency Noise		$I_R = 1.2\mu\text{A}$ , $f = 0.1\text{Hz}$ to $10\text{Hz}$		75		$\mu\text{V}_{p-p}$	
Temperature Coefficient (Note 3)	TC	$I_R = 1.2\mu\text{A}$	MAX6009A		30	ppm/ $^\circ\text{C}$	
			MAX6009B		75		
Long-Term Drift		1000h at $T_A = +25^\circ\text{C}$		150		ppm	
Thermal Hysteresis (Note 4)				200		ppm	

**Note 1:** All devices are 100% production tested at  $T_A = +25^\circ\text{C}$  and are guaranteed by design for  $T_A = T_{MIN}$  to  $T_{MAX}$ , as specified.

**Note 2:** This parameter is guaranteed by the "reverse breakdown change with current" test.

**Note 3:** TC is measured by the "box" method; i.e.,  $(V_{MAX} - V_{MIN}) / (T_{MAX} - T_{MIN})$ .

**Note 4:** Thermal hysteresis is defined as the change in the  $+25^\circ\text{C}$  output voltage after cycling the device from  $T_{MIN}$  to  $T_{MAX}$ .

## Typical Operating Characteristics

( $C_L = 0.01\mu\text{F}$ ,  $T_A = +25^\circ\text{C}$ , unless otherwise noted.)

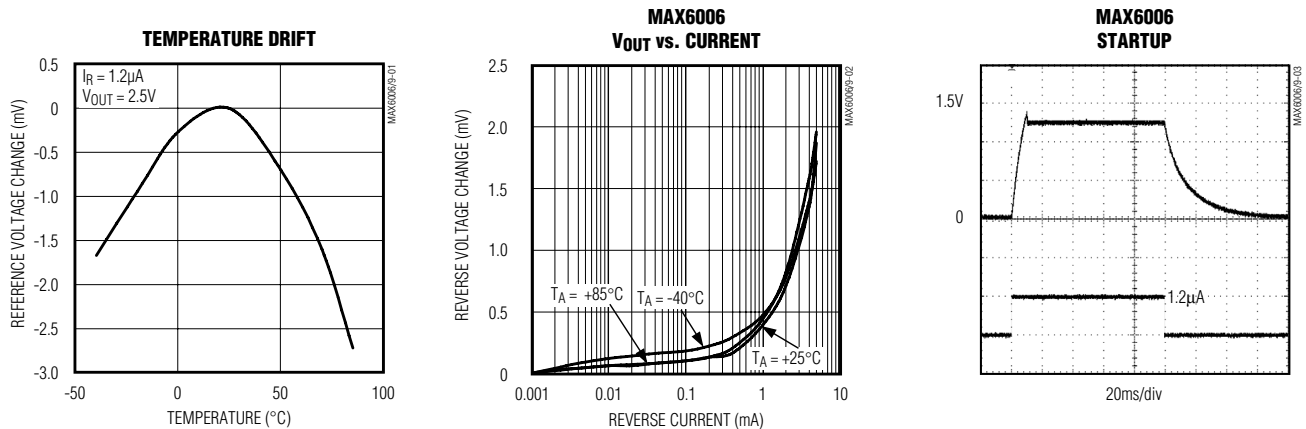

# 1 $\mu$ A SOT23 Precision Shunt Voltage Reference

## Typical Operating Characteristics (continued)

( $C_L = 0.01\mu\text{F}$ ,  $T_A = +25^\circ\text{C}$ , unless otherwise noted.)

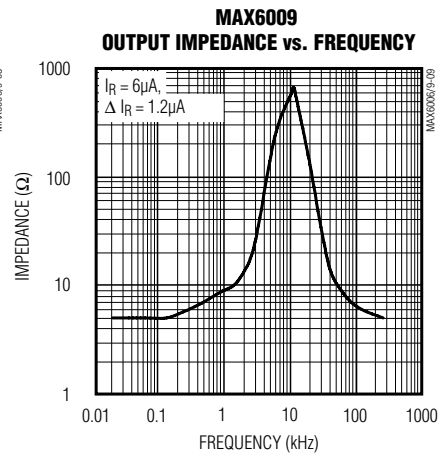
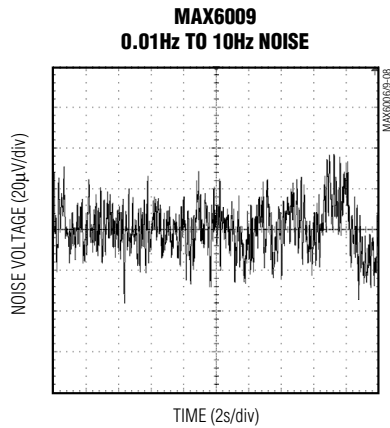
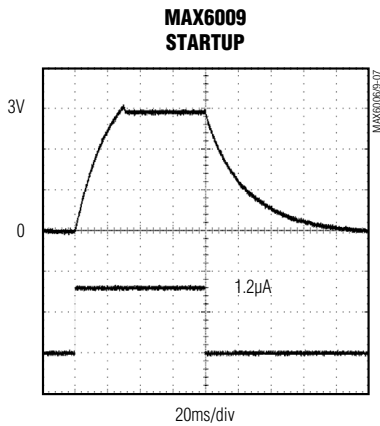
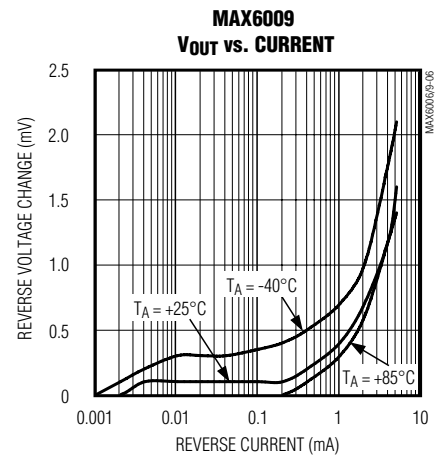
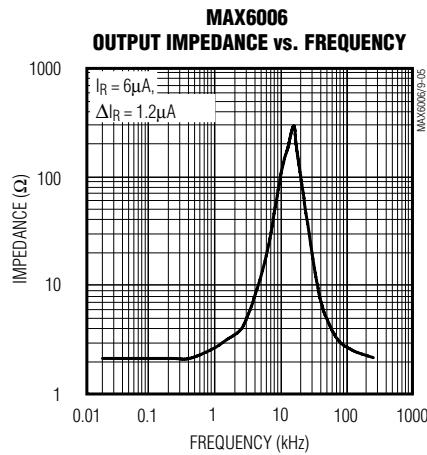
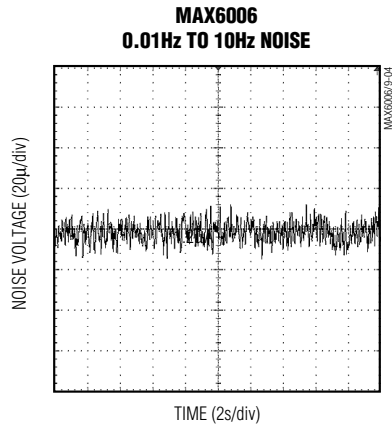

**MAX6006-MAX6009**

# 1 $\mu$ A SOT23 Precision Shunt Voltage Reference

## Pin Description

PIN		NAME	FUNCTION
SOT23	SO		Output Voltage. Bias OUT with a pullup resistor to a potential greater than OUT. Bypass OUT to GND with a 0.01 $\mu$ F or larger capacitor.
1	6, 8	OUT	
2	4	GND	Ground
3	—	IC	Internally connected test point. Leave this pin unconnected, or connect to GND.
—	1, 2, 3, 5, 7	N.C.	No connection. Not internally connected.

## Detailed Description

The MAX6006–MAX6009 are precision, two-terminal, series bandgap voltage references. On-chip thin-film resistors are laser trimmed to provide 0.2% output voltage accuracies. Voltages of +1.25V, +2.048V, +2.5V, and +3.0V are available in the space-saving SOT23 package (2.1mm  $\times$  2.7mm).

## Applications Information

### Output/Load Capacitance

For devices in this family, OUT needs to be bypassed to GND with a 0.01 $\mu$ F or larger capacitor. In applications where the load or the supply can experience step changes, additional capacitance will reduce the amount of overshoot (or undershoot) and assist the circuit's transient response.

### Output Voltage Hysteresis

Output voltage hysteresis is the change in the output voltage at  $T_A = +25^\circ\text{C}$  before and after the device is cycled over its entire operating temperature range. Hysteresis is caused by differential package stress appearing across the bandgap core transistors. The temperature hysteresis value is typically less than 200ppm.

### Turn-On Time

The output capacitance and bias current of the MAX6006–MAX6009 greatly affects turn-on settling time. In the *Typical Operating Characteristics*, turn-on time is shown with a 10nF output capacitor and a 1.2 $\mu$ A bias current. Under these conditions, the MAX6006–MAX6009 settle in 40ms. Settling time will linearly decrease in proportion to the circuit's bias current.

## Typical Applications

In the typical shunt regulator application shown in Figure 1,  $R_{BIAS}$  is used to set the current through the load ( $I_L$ ) and the current through the shunt regulator ( $I_{RMIN}$ ). There are two worst-case situations that  $R_{BIAS}$  needs to be sized for:

- 1)  $R_{BIAS}$  must be small enough that when  $V_S$  (supply voltage) is at its minimum and  $I_L$  is at its maximum,  $I_{RMIN}$  is equal to at least the minimum operating current of the shunt regulator.
- 2)  $R_{BIAS}$  must be large enough that when  $V_S$  is at its maximum and  $I_L$  is at its minimum,  $I_{RMIN}$  is  $< 2\text{mA}$ .

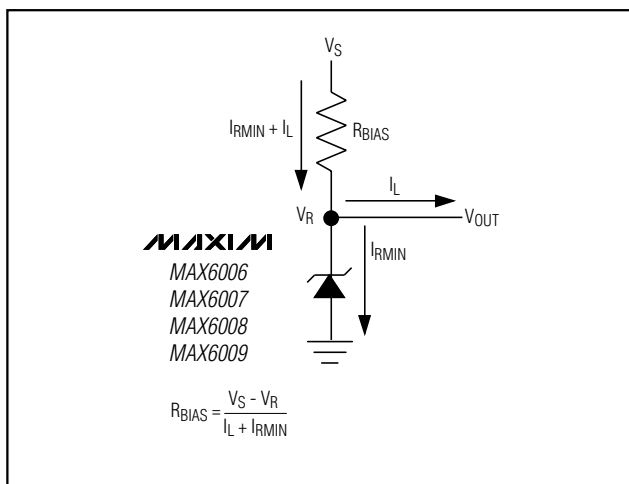

Figure 1. Typical Application Circuit

# 1µA SOT23 Precision Shunt Voltage Reference

MAX6006-MAX6009

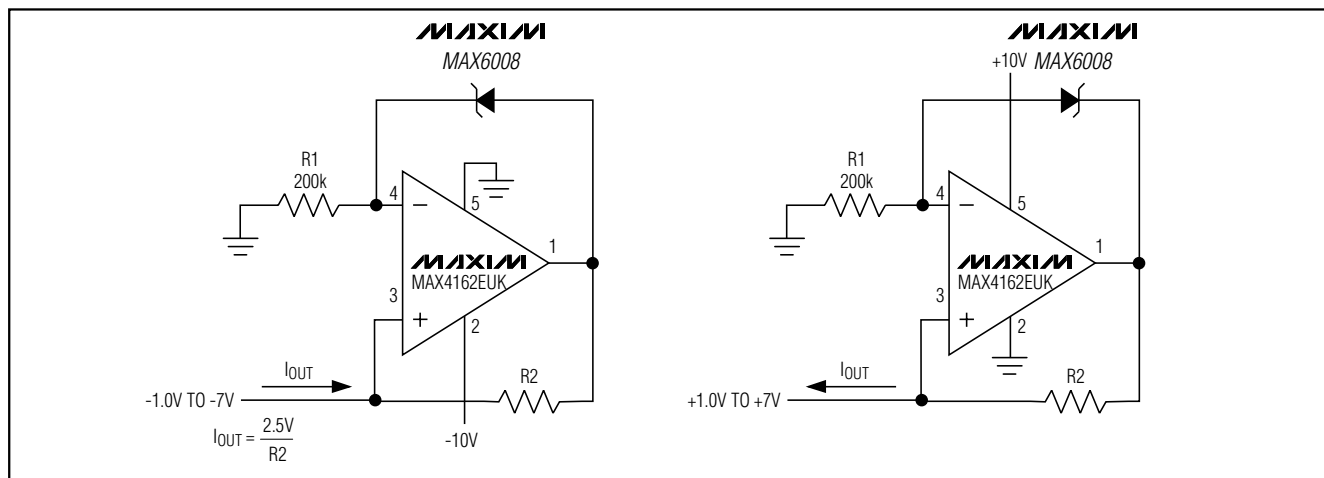

Figure 2. Precision 1µA to 1mA Current Sources

## Ordering Information

## Chip Information

PART	TEMP. RANGE	PIN-PACKAGE	TOP MARK
MAX6006AEUR-T	-40°C to +85°C	3 SOT23	FZGH
MAX6006AESA	-40°C to +85°C	8 SO	—
MAX6006BEUR-T	-40°C to +85°C	3 SOT23	FZGI
MAX6006BESA	-40°C to +85°C	8 SO	—
MAX6007AEUR-T	-40°C to +85°C	3 SOT23	FZGK
MAX6007BEUR-T	-40°C to +85°C	3 SOT23	FZGL
MAX6008AEUR-T	-40°C to +85°C	3 SOT23	FZGN
MAX6008AESA	-40°C to +85°C	8 SO	—
MAX6008BEUR-T	-40°C to +85°C	3 SOT23	FZGO
MAX6008BESA	-40°C to +85°C	8 SO	—
MAX6009AEUR-T	-40°C to +85°C	3 SOT23	FZGQ
MAX6009BEUR-T	-40°C to +85°C	3 SOT23	FZGR

TRANSISTOR COUNT: 60  
PROCESS: BiCMOS

# 1μA SOT23 Precision Shunt Voltage Reference

## Package Information

NOTES:

1. D&E DO NOT INCLUDE MOLD FLASH.
2. MOLD FLASH OR PROTRUSIONS NOT TO EXCEED .15mm (.006")
3. CONTROLLING DIMENSION: MILLIMETER

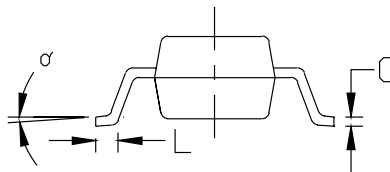
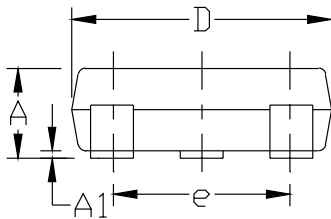
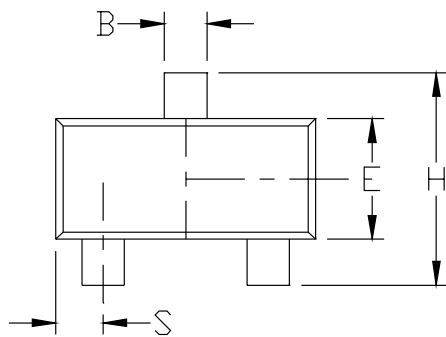

DIM	INCHES		MILLIMETERS	
	MIN	MAX	MIN	MAX
A	0.031	0.047	0.787	1.194
A1	0.001	0.005	0.025	0.127
B	0.014	0.022	0.356	0.559
C	0.0034	0.006	0.086	0.152
D	0.105	0.120	2.667	3.048
E	0.047	0.055	1.194	1.397
e	0.070	0.080	1.778	2.032
H	0.082	0.098	2.083	2.489
L	0.004	0.012	0.102	0.305
S	0.017	0.022	0.432	0.559
α	0°	8°	0°	8°

**MAXIM**  
 PROPRIETARY INFORMATION  
 TITLE:  
 PACKAGE OUTLINE, SOT-23, 3L  
 APPROVAL: \_\_\_\_\_ DOCUMENT CONTROL NO. 21-0051 REV C 1/1

SOT23LEFS

Maxim cannot assume responsibility for use of any circuitry other than circuitry entirely embodied in a Maxim product. No circuit patent licenses are implied. Maxim reserves the right to change the circuitry and specifications without notice at any time.

8 Maxim Integrated Products, 120 San Gabriel Drive, Sunnyvale, CA 94086 408-737-7600