

## Optocoupler, Phototriac Output

### Features

- $I_{TRMS} = 300 \text{ mA}$
- High Static  $dV_{crq}/dt < 10,000 \text{ V}/\mu\text{s}$
- Electrically Insulated between Input and output circuit
- Microcomputer compatible - Very Low Trigger Current
- Non-zero voltage detectors High input Sensitivity

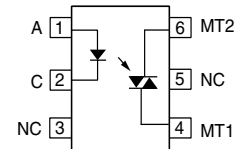
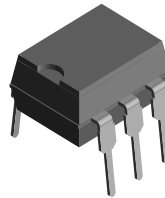

1179041

### Agency Approvals

- UL - File No. E52744 System Code J
- DIN EN 60747-5-2(VDE0884)  
DIN EN 60747-5-5 pending  
Available with Option 1

### Applications

Industrial controls  
Office equipment  
Consumer appliances

### Description

The BRT11/12/13 are AC optocouplers non-zero voltage detectors consisting of two electrically insulated lateral power ICs which integrate a thyristor system, a photo detector and noise suppression at the output and an IR GaAs diode input.

### Order Information

Part	Remarks
BRT11-H	400 V $V_{DRM}$ , 2 mA $I_{FT}$ , DIP-6
BRT12-H	600 V $V_{DRM}$ , 2 mA $I_{FT}$ , DIP-6
BRT13-H	800 V $V_{DRM}$ , 2 mA $I_{FT}$ , DIP-6
BRT11-M	400 V $V_{DRM}$ , 3 mA $I_{FT}$ , DIP-6
BRT12-M	600 V $V_{DRM}$ , 3 mA $I_{FT}$ , DIP-6
BRT13-M	800 V $V_{DRM}$ , 3 mA $I_{FT}$ , DIP-6
BRT12-H-X006	600 V $V_{DRM}$ , 2 mA $I_{FT}$ , DIP-6 400 mil (option 6)
BRT12-H-X007	600 V $V_{DRM}$ , 2 mA $I_{FT}$ , SMD-6 (option 7)
BRT12-H-X009	600 V $V_{DRM}$ , 2 mA $I_{FT}$ , SMD-6 (option 9)
BRT13-H-X006	800 V $V_{DRM}$ , 2 mA $I_{FT}$ , DIP-6 400 mil (option 6)
BRT13-H-X007	800 V $V_{DRM}$ , 2 mA $I_{FT}$ , SMD-6 (option 7)
BRT13-H-X009	800 V $V_{DRM}$ , 2 mA $I_{FT}$ , SMD-6 (option 9)
BRT12-M-X006	600 V $V_{DRM}$ , 3 mA $I_{FT}$ , DIP-6 400 mil (option 6)

For additional information on the available options refer to Option Information.

### Absolute Maximum Ratings

$T_{amb} = 25\text{ °C}$ , unless otherwise specified

Stresses in excess of the absolute Maximum Ratings can cause permanent damage to the device. Functional operation of the device is not implied at these or any other conditions in excess of those given in the operational sections of this document. Exposure to absolute Maximum Rating for extended periods of the time can adversely affect reliability.

### Input

Parameter	Test condition	Symbol	Value	Unit
Reverse voltage		$V_R$	6	V
Forward continuous current		$I_F$	20	mA
Surge forward current		$I_{FSM}$	1.5	A
Power dissipation	$t \leq 10\ \mu\text{s}$	$P_{diss}$	30	mW

### Output

Parameter	Test condition	Part	Symbol	Value	Unit
Repetitive peak off-state voltage		BRT11	$V_{DRM}$	400	V
		BRT12	$V_{DRM}$	600	V
		BRT13	$V_{DRM}$	800	V
RMS on-state current			$I_{TRMS}$	300	mA
Single cycle surge current	50 Hz		$I_{TSM}$	3	A
Power dissipation			$P_{diss}$	600	mW

### Coupler

Parameter	Test condition	Symbol	Value	Unit
Max. power dissipation		$P_{tot}$	630	mW
Ambient temperature		$T_{amb}$	- 40 to + 100	°C
Storage temperature		$T_{stg}$	- 40 to + 150	°C
Insulation test voltage <sup>1)</sup> between input/output circuit (climate in acc. with DIN 40046, part 2, Nov. 74)		$V_{ISO}$	5300	$V_{RMS}$
Reference voltage in acc. with VDE 0110 b		$V_{ref}$	500	$V_{RMS}$
Reference voltage in acc. with VDE 0110 b (insulation group C)		$V_{ref}$	600	$V_{DC}$
Creepage resistance (in acc. with DIN IEC 112/VDE 0303, part 1)	(group IIIa acc. to DIN VDE 0109)	CTI	175	
Insulation resistance	$V_{IO} = 500\text{ V}, T_{amb} = 25\text{ °C}$	$R_{IO}$	$\geq 10^{12}$	$\Omega$
	$V_{IO} = 500\text{ V}, T_{amb} = 100\text{ °C}$	$R_{IO}$	$\geq 10^{11}$	$\Omega$
DIN humidity category, DIN 40 040			F	
Creepage distance (input/output circuit)			$\geq 7.2$	mm
Clearance (input/output circuit)			$\geq 7.2$	mm

<sup>1)</sup> Test AC voltage in acc. with DIN 57883, June 1980

### Electrical Characteristics

$T_{amb} = 25\text{ }^{\circ}\text{C}$ , unless otherwise specified

Minimum and maximum values are testing requirements. Typical values are characteristics of the device and are the result of engineering evaluation. Typical values are for information only and are not part of the testing requirements.

### Input

Parameter	Test condition	Symbol	Min	Typ.	Max	Unit
Forward voltage	$I_F = 10\text{ mA}$	$V_F$		1.1	1.35	V
Reverse current	$V_R = 6\text{ V}$	$I_R$			10	$\mu\text{A}$
Thermal resistance <sup>2)</sup> junction - ambient		$R_{thja}$			750	$^{\circ}\text{C/W}$

<sup>2)</sup> Static air, SITAC soldered in pcb or base plate.

### Output

Parameter	Test condition	Symbol	Min	Typ.	Max	Unit
Critical rate of rise of off-state voltage	$V_D = 0.67 V_{DRM}, T_J = 25\text{ }^{\circ}\text{C}$	$dV/dt_{cr}$	10			$\text{kV}/\mu\text{s}$
	$V_D = 0.67 V_{DRM}, T_J = 80\text{ }^{\circ}\text{C}$	$dV/dt_{cr}$	5			$\text{kV}/\mu\text{s}$
Critical rate of rise of voltage at current commutation	$V_D = 0.67 V_{DRM}, T_J = 25\text{ }^{\circ}\text{C},$ $di/dt_{crq} \leq 15\text{ A/ms}$	$dV/dt_{crq}$	10			$\text{kV}/\mu\text{s}$
	$V_D = 0.67 V_{DRM}, T_J = 80\text{ }^{\circ}\text{C},$ $di/dt_{crq} \leq 15\text{ A/ms}$	$dV/dt_{crq}$	5			$\text{kV}/\mu\text{s}$
Critical rate of rise of on-state current		$di/dt_{cr}$	8			$\text{A}/\mu\text{s}$
Pulse current	$t_p \leq 5\text{ }\mu\text{s}, f 0\text{ }100\text{ Hz},$ $di_{tp}/dt \leq 8\text{ A}/\mu\text{s}$	$I_{tp}$			2	A
On-state voltage	$I_T = 300\text{ mA}$	$V_T$			2.3	V
Off-state current	$T_C = 80\text{ }^{\circ}\text{C}, V_{DRM}$	$I_D$		0.5	100	$\mu\text{A}$
Holding current	$V_D = 10\text{ V}$	$I_H$		80	500	$\mu\text{A}$
Thermal resistance <sup>2)</sup> junction - ambient	$R_{thJA}$	$R_{thja}$			125	$^{\circ}\text{C/W}$

<sup>2)</sup> Static air, SITAC soldered in pcb or base plate.

### Coupler

Parameter	Test condition	Symbol	Min	Typ.	Max	Unit
Trigger current	$V_D = 10\text{ V}, \text{H - Versions}$	$I_{FT}$	0.4		2	$\text{mA}$
	$V_D = 10\text{ V}, \text{M - Versions}$	$I_{FT}$	0.8		3	$\text{mA}$
Trigger current temperature gradient		$\Delta I_{FT}/\Delta T_j$		7	14	$\mu\text{A}/^{\circ}\text{C}$
Capacitance (input-output)	$V_R = 0\text{ V}, f = 1\text{ kHz}$	$C_{IO}$			2	$\text{pF}$

## Typical Characteristics ( $T_{amb} = 25\text{ }^{\circ}\text{C}$ unless otherwise specified)

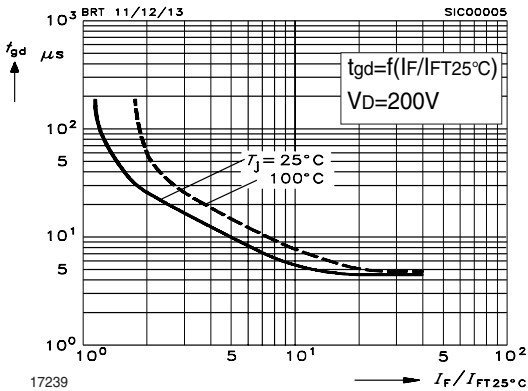

Fig. 1 Typical Trigger Delay Time

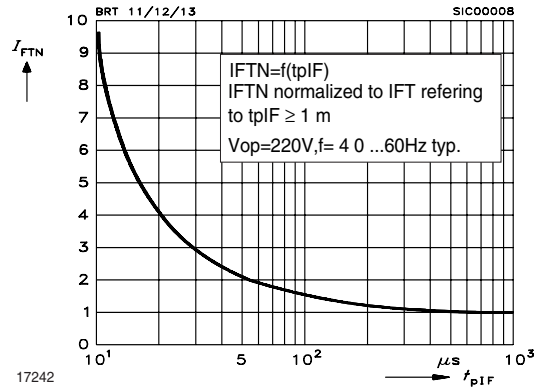

Fig. 4 Pulse Trigger Current

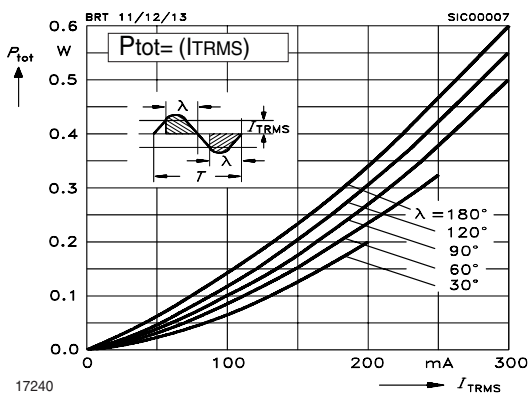

Fig. 2 Power Dissipation 40 to 60 Hz Line Operation

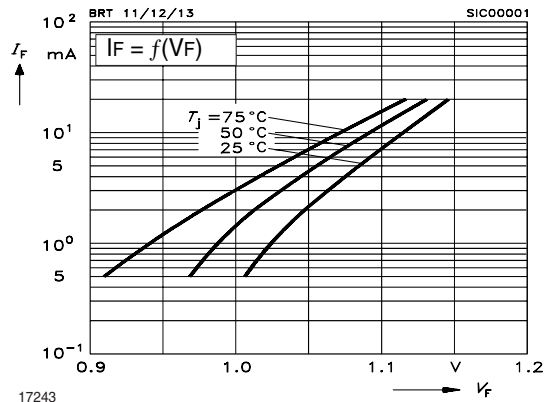

Fig. 5 Typical Input Characteristics

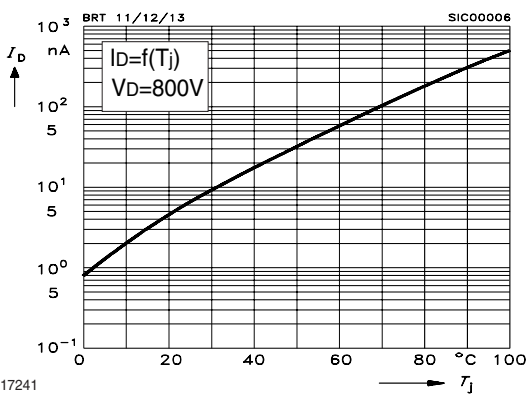

Fig. 3 Typical Off-State Current

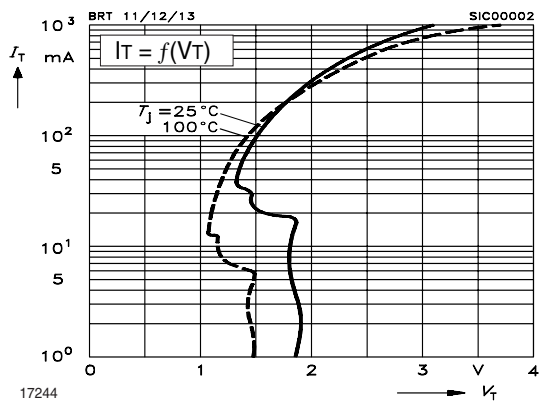

Fig. 6 Typical Output Characteristics

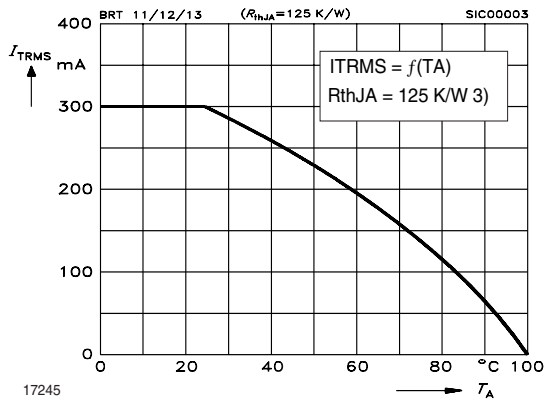

Fig. 7 Current Reduction

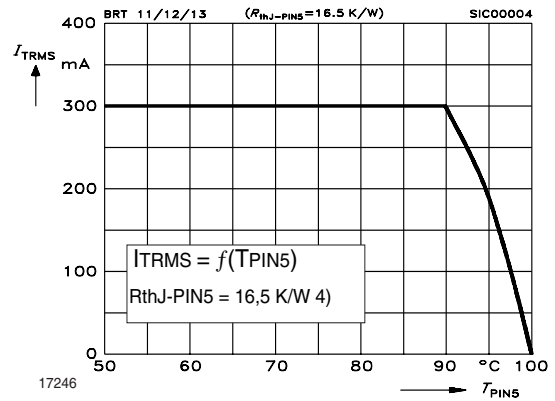
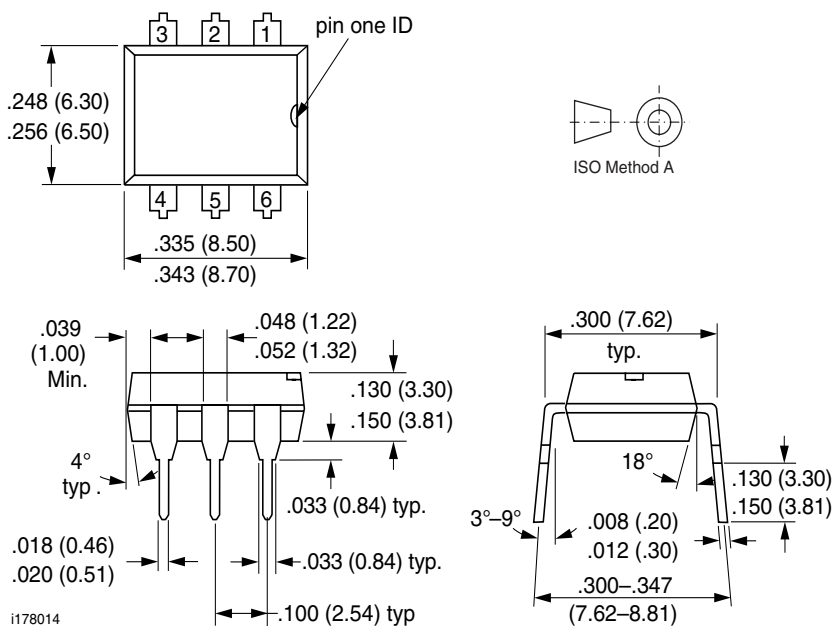
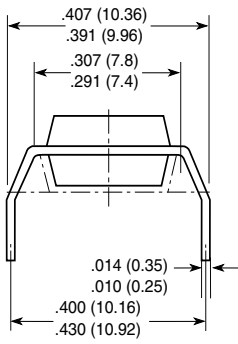

Fig. 8 Current Reduction

## Package Dimensions in Inches (mm)



Option 6



Option 7

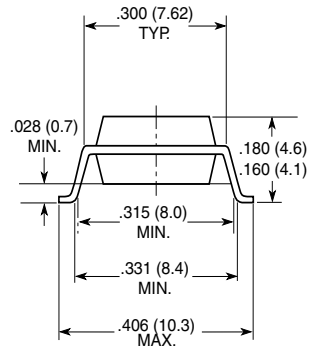

Option 9

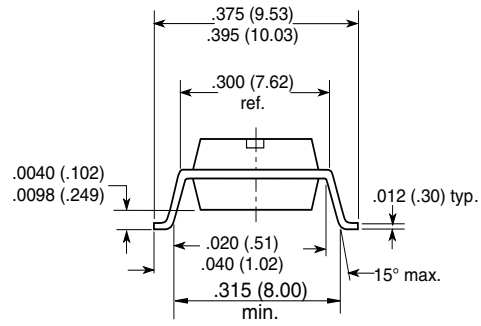

18450



## **Ozone Depleting Substances Policy Statement**

It is the policy of **Vishay Semiconductor GmbH** to

1. Meet all present and future national and international statutory requirements.
2. Regularly and continuously improve the performance of our products, processes, distribution and operating systems with respect to their impact on the health and safety of our employees and the public, as well as their impact on the environment.

It is particular concern to control or eliminate releases of those substances into the atmosphere which are known as ozone depleting substances (ODSs).

The Montreal Protocol (1987) and its London Amendments (1990) intend to severely restrict the use of ODSs and forbid their use within the next ten years. Various national and international initiatives are pressing for an earlier ban on these substances.

**Vishay Semiconductor GmbH** has been able to use its policy of continuous improvements to eliminate the use of ODSs listed in the following documents.

1. Annex A, B and list of transitional substances of the Montreal Protocol and the London Amendments respectively
2. Class I and II ozone depleting substances in the Clean Air Act Amendments of 1990 by the Environmental Protection Agency (EPA) in the USA
3. Council Decision 88/540/EEC and 91/690/EEC Annex A, B and C (transitional substances) respectively.

**Vishay Semiconductor GmbH** can certify that our semiconductors are not manufactured with ozone depleting substances and do not contain such substances.

**We reserve the right to make changes to improve technical design  
and may do so without further notice.**

Parameters can vary in different applications. All operating parameters must be validated for each customer application by the customer. Should the buyer use Vishay Semiconductors products for any unintended or unauthorized application, the buyer shall indemnify Vishay Semiconductors against all claims, costs, damages, and expenses, arising out of, directly or indirectly, any claim of personal damage, injury or death associated with such unintended or unauthorized use.

Vishay Semiconductor GmbH, P.O.B. 3535, D-74025 Heilbronn, Germany  
Telephone: 49 (0)7131 67 2831, Fax number: 49 (0)7131 67 2423