

6-Pin DIP Optoisolators Darlington Output (On-Chip Resistors)

The H11G1, H11G2 and H11G3 devices consist of gallium arsenide IREDs optically coupled to silicon photodarlington detectors which have integral base-emitter resistors. The on-chip resistors improve higher temperature leakage characteristics. Designed with high isolation, high CTR, high voltage and low leakage, they provide excellent performance.

- High CTR, H11G1 & H11G2 — 1000% (@ $I_F = 10 \text{ mA}$), 500% (@ $I_F = 1 \text{ mA}$)
- High $V_{(BR)CEO}$, H11G1 — 100 Volts, H11G2 — 80 Volts
- **To order devices that are tested and marked per VDE 0884 requirements, the suffix "V" must be included at end of part number. VDE 0884 is a test option.**

Applications

- Interfacing and coupling systems of different potentials and impedances
- Phase and Feedback Controls
- General Purpose Switching Circuits
- Solid State Relays

MAXIMUM RATINGS ($T_A = 25^\circ\text{C}$ unless otherwise noted)

Rating	Symbol	Value	Unit
--------	--------	-------	------

INPUT LED

Reverse Voltage	V_R	6	Volts
Forward Current — Continuous	I_F	60	mA
Forward Current — Peak Pulse Width = 300 μs , 2% Duty Cycle	I_F	3	Amps
LED Power Dissipation @ $T_A = 25^\circ\text{C}$ Derate above 25°C	P_D	120 1.41	mW mW/ $^\circ\text{C}$

OUTPUT DETECTOR

Collector–Emitter Voltage	H11G1 H11G2 H11G3	V_{CEO}	100 80 55	Volts
Emitter–Base Voltage		V_{EBO}	7	Volts
Collector Current — Continuous		I_C	150	mA
Detector Power Dissipation @ $T_A = 25^\circ\text{C}$ Derate above 25°C		P_D	150 1.76	mW mW/ $^\circ\text{C}$

TOTAL DEVICE

Total Device Power Dissipation @ $T_A = 25^\circ\text{C}$ Derate above 25°C	P_D	250 2.94	mW mW/ $^\circ\text{C}$
Operating Junction Temperature Range ⁽²⁾	T_A	–55 to +100	$^\circ\text{C}$
Storage Temperature Range ⁽²⁾	T_{stg}	–55 to +150	$^\circ\text{C}$
Soldering Temperature (10 s)	T_L	260	$^\circ\text{C}$
Isolation Surge Voltage ⁽¹⁾ (Peak ac Voltage, 60 Hz, 1 sec Duration)	V_{ISO}	7500	Vac(pk)

1. Isolation surge voltage is an internal device dielectric breakdown rating. For this test, Pins 1 and 2 are common, and Pins 4, 5 and 6 are common.
2. Refer to Quality and Reliability Section in Opto Data Book for information on test conditions.

Preferred devices are Motorola recommended choices for future use and best overall value. GlobalOptoisolator is a trademark of Motorola, Inc.

H11G1*

[CTR = 1000% Min]

H11G2*

[CTR = 1000% Min]

H11G3

[CTR = 200% Min]

*Motorola Preferred Devices

STYLE 1 PLASTIC

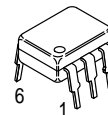

STANDARD THRU HOLE
CASE 730A-04

SCHEMATIC

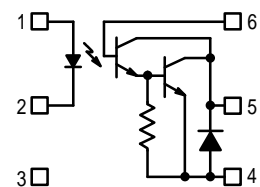

- PIN 1. ANODE
- 2. CATHODE
- 3. N.C.
- 4. EMITTER
- 5. COLLECTOR
- 6. BASE

H11G1 H11G2 H11G3

ELECTRICAL CHARACTERISTICS (T_A = 25°C unless otherwise noted)⁽¹⁾

Characteristic	Symbol	Min	Typ ⁽¹⁾	Max	Unit
INPUT LED					
Reverse Leakage Current (V _R = 3 V)	I _R	—	0.05	10	μA
Forward Voltage I _F = 10 mA)	V _F	—	1.1	1.5	Volts
Capacitance (V = 0 V, f = 1 MHz)	C _J	—	18	—	pF

DARLINGTON OUTPUT (T_A = 25°C and I_F = 0 unless otherwise noted)

Collector–Emitter Breakdown Current (I _C = 1 mA, I _F = 0)	H11G1 H11G2 H11G3	V _{(BR)CEO}	100 80 55	— — —	— — —	Volts
Collector–Base Breakdown Voltage (I _C = 100 μA, I _F = 0)	H11G1 H11G2 H11G3	V _{(BR)CBO}	100 80 55	— — —	— — —	Volts
Emitter–Base Breakdown Voltage (I _E = 100 μA, I _F = 0)		V _{(BR)EBO}	7	—	—	Volts
Collector–Emitter Dark Current (V _{CE} = 80 V)	H11G1	I _{CEO}	—	—	100	nA
(V _{CE} = 80 V, T _A = 80°C)	H11G1		—	—	100	μA
(V _{CE} = 60 V)	H11G2		—	—	100	nA
(V _{CE} = 60 V, T _A = 80°C)	H11G2		—	—	100	μA
(V _{CE} = 30 V)	H11G3		—	—	100	nA
Capacitance (V _{CB} = 10 V, f = 1 MHz)		C _{CB}	—	6	—	pF

COUPLED (T_A = 25°C unless otherwise noted)

Collector Output Current (V _{CE} = 1 V, I _F = 10 mA)	H11G1, 2	I _C (CTR) ⁽²⁾	100 (1000)	—	—	mA (%)
(V _{CE} = 5 V, I _F = 1 mA)	H11G1, 2		5 (500)	—	—	
(V _{CE} = 5 V, I _F = 1 mA)	H11G3		2 (200)	—	—	
Collector–Emitter Saturation Voltage (I _F = 1 mA, I _C = 1 mA)	H11G1, 2	V _{CE(sat)}	—	0.75	1	Volts
(I _F = 16 mA, I _C = 50 mA)	H11G1, 2		—	0.85	1	
(I _F = 20 mA, I _C = 50 mA)	H11G3		—	0.85	1.2	
Isolation Surge Voltage ^(3,4) (60 Hz ac Peak, 1 Second)		V _{ISO}	7500	—	—	Vac(pk)
Isolation Resistance ⁽³⁾ (V = 500 Vdc)			—	10 ¹¹	—	Ohms
Isolation Capacitance ⁽³⁾ (V = 0 V, f = 1 MHz)		C _{IO}	—	2	—	pF

SWITCHING (T_A = 25°C)

Turn–On Time	(I _F = 10 mA, V _{CC} = 5 V, R _L = 100 Ω, Pulse Width ≤ 300 μs, f = 30 Hz)	t _{on}	—	5	—	μs
Turn–Off Time		t _{off}	—	100	—	

1. Always design to the specified minimum/maximum electrical limits (where applicable).
2. Current Transfer Ratio (CTR) = I_C/I_F x 100%.
3. For this test, Pins 1 and 2 are common, and Photodarlington Pins 4 and 5 are common.
4. Isolation Surge Voltage, V_{ISO}, is an internal device dielectric breakdown rating.

TYPICAL CHARACTERISTICS

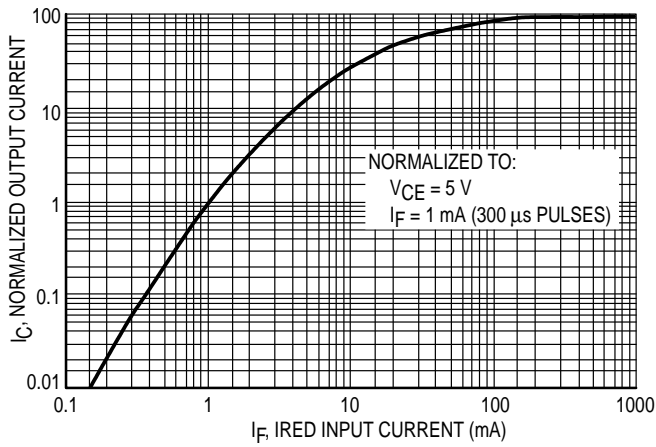

Figure 1. Output Current versus Input Current

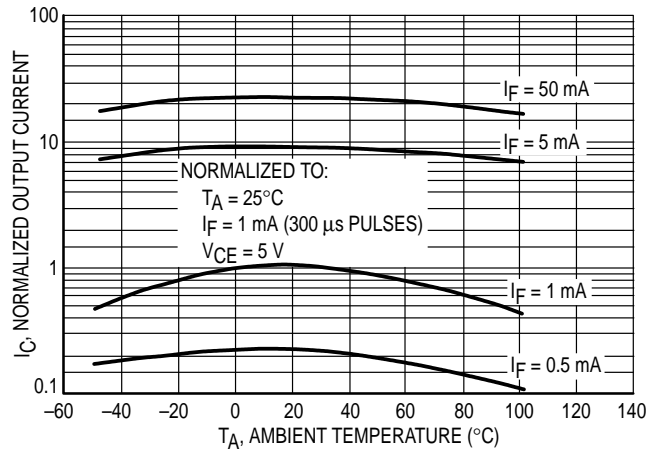

Figure 2. Output Current versus Temperature

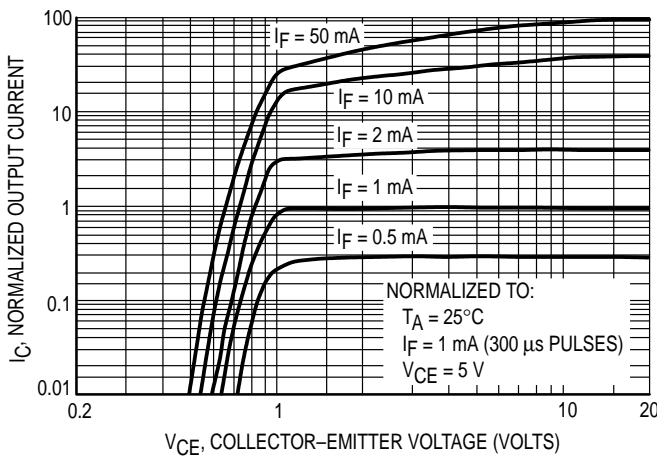

Figure 3. Output Current versus Collector-Emitter Voltage

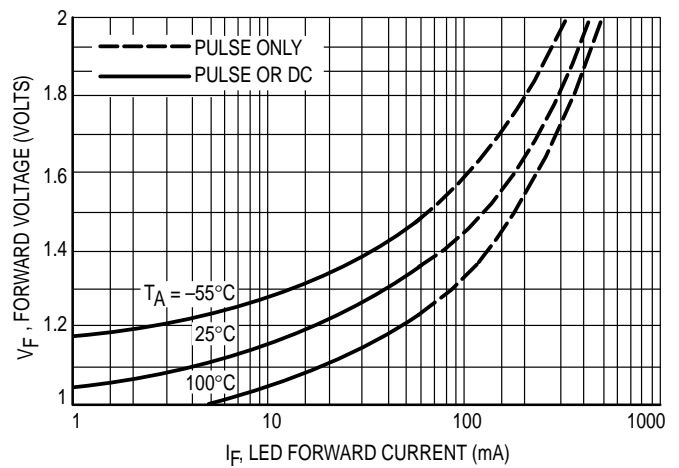

Figure 4. LED Forward Characteristics

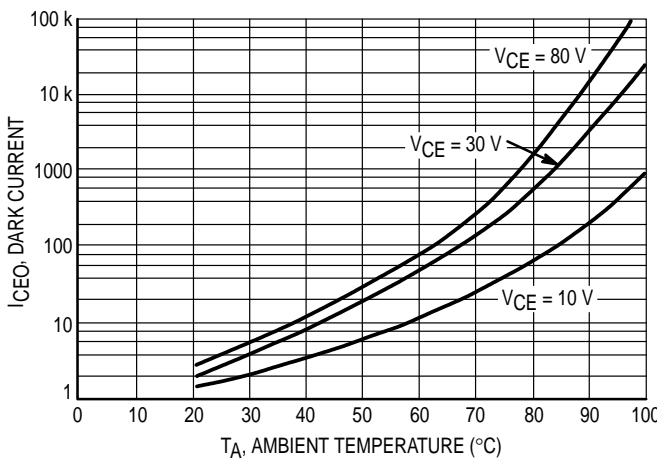

Figure 5. Collector-Emitter Dark Current versus Temperature

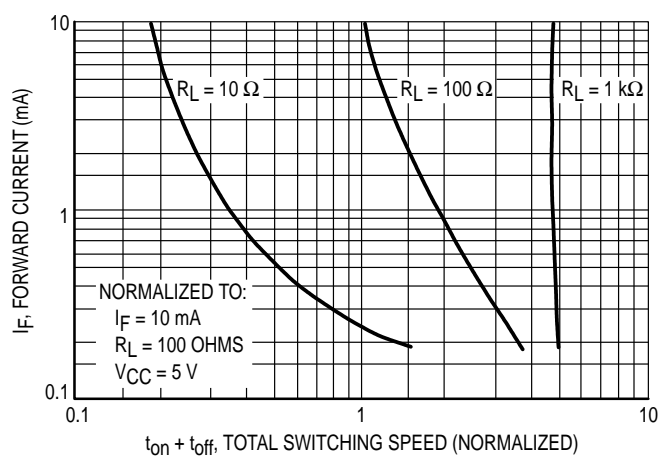
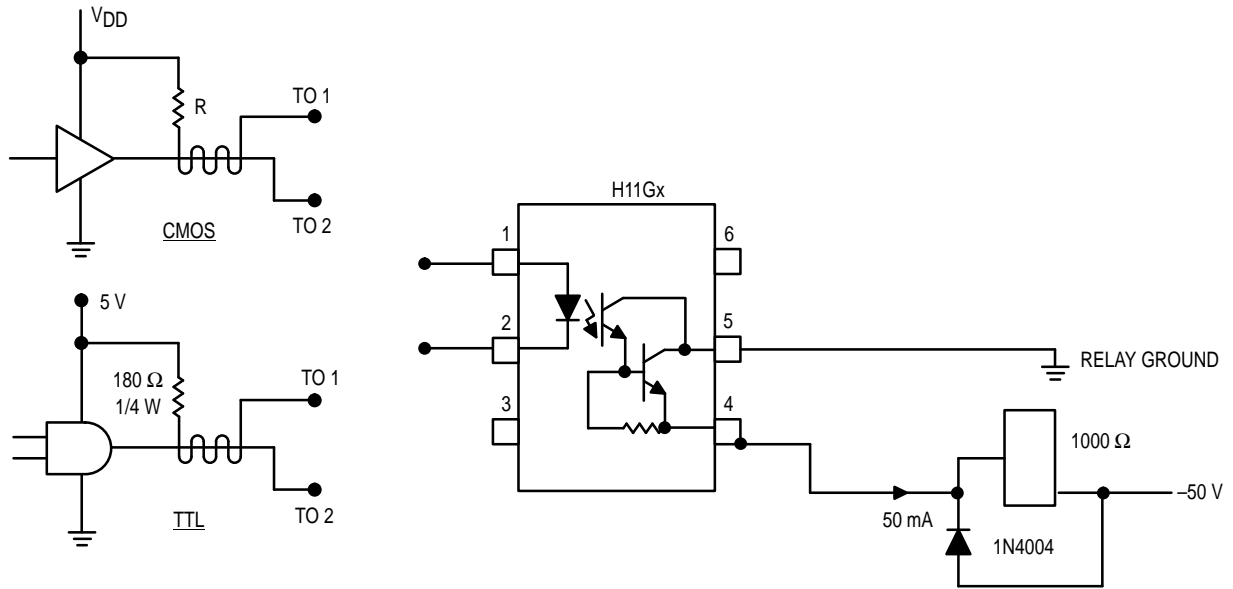

Figure 6. Input Current versus Total Switching Speed (Typical Values)

H11G1 H11G2 H11G3

INTERFACING TTL OR CMOS LOGIC TO 50-VOLT, 1000-OHMS RELAY FOR TELEPHONY APPLICATIONS

In order to interface positive logic to negative-powered electromechanical relays, a change in voltage level and polarity plus electrical isolation are required. The H11Gx can provide this interface and eliminate the external amplifiers and voltage divider networks previously required. The circuit below shows a typical approach for the interface.



PACKAGE DIMENSIONS

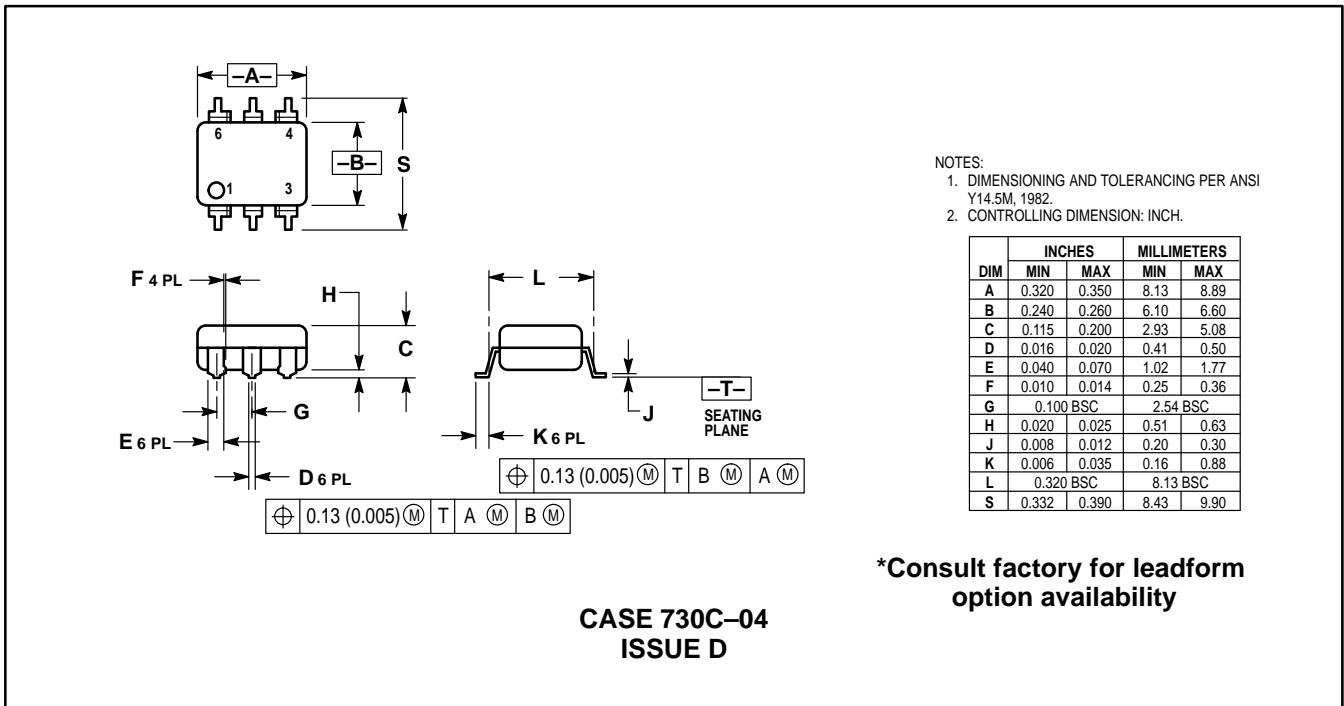
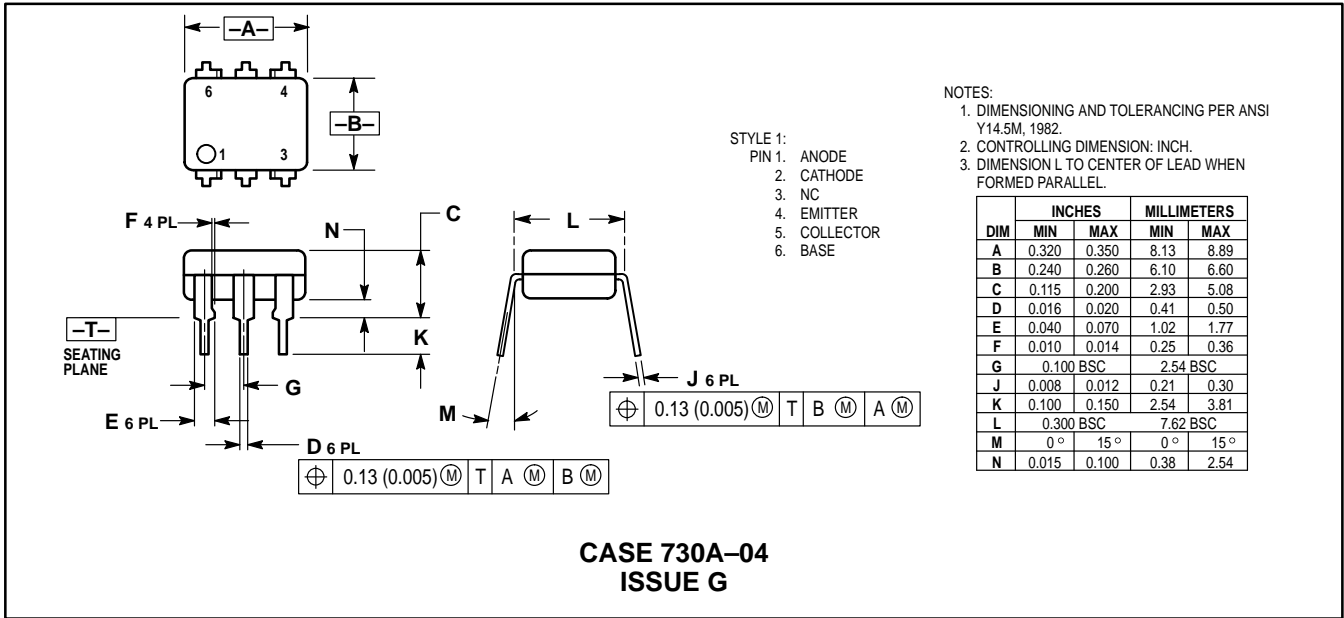

H11G1 H11G2 H11G3



- NOTES:
1. DIMENSIONING AND TOLERANCING PER ANSI Y14.5M, 1982.
 2. CONTROLLING DIMENSION: INCH.
 3. DIMENSION L TO CENTER OF LEAD WHEN FORMED PARALLEL.

DIM	INCHES		MILLIMETERS	
	MIN	MAX	MIN	MAX
A	0.320	0.350	8.13	8.89
B	0.240	0.260	6.10	6.60
C	0.115	0.200	2.93	5.08
D	0.016	0.020	0.41	0.50
E	0.040	0.070	1.02	1.77
F	0.010	0.014	0.25	0.36
G	0.100 BSC		2.54 BSC	
J	0.008	0.012	0.21	0.30
K	0.100	0.150	2.54	3.81
L	0.400	0.425	10.16	10.80
N	0.015	0.040	0.38	1.02

***Consult factory for leadform option availability**

**CASE 730D-05
ISSUE D**

Motorola reserves the right to make changes without further notice to any products herein. Motorola makes no warranty, representation or guarantee regarding the suitability of its products for any particular purpose, nor does Motorola assume any liability arising out of the application or use of any product or circuit, and specifically disclaims any and all liability, including without limitation consequential or incidental damages. "Typical" parameters can and do vary in different applications. All operating parameters, including "Typicals" must be validated for each customer application by customer's technical experts. Motorola does not convey any license under its patent rights nor the rights of others. Motorola products are not designed, intended, or authorized for use as components in systems intended for surgical implant into the body, or other applications intended to support or sustain life, or for any other application in which the failure of the Motorola product could create a situation where personal injury or death may occur. Should Buyer purchase or use Motorola products for any such unintended or unauthorized application, Buyer shall indemnify and hold Motorola and its officers, employees, subsidiaries, affiliates, and distributors harmless against all claims, costs, damages, and expenses, and reasonable attorney fees arising out of, directly or indirectly, any claim of personal injury or death associated with such unintended or unauthorized use, even if such claim alleges that Motorola was negligent regarding the design or manufacture of the part. Motorola and are registered trademarks of Motorola, Inc. Motorola, Inc. is an Equal Opportunity/Affirmative Action Employer.

How to reach us:

USA / EUROPE: Motorola Literature Distribution;
P.O. Box 20912; Phoenix, Arizona 85036. 1-800-441-2447

JAPAN: Nippon Motorola Ltd.; Tatsumi-SPD-JLDC, Toshikatsu Otsuki,
6F Seibu-Butsuryu-Center, 3-14-2 Tatsumi Koto-Ku, Tokyo 135, Japan. 03-3521-8315

MFAX: RMFAX0@email.sps.mot.com – TOUCHTONE (602) 244-6609
INTERNET: http://Design-NET.com

HONG KONG: Motorola Semiconductors H.K. Ltd.; 8B Tai Ping Industrial Park,
51 Ting Kok Road, Tai Po, N.T., Hong Kong. 852-26629298

