

Switching diode

FMN1 / FMP1 / IMN10 / IMN11 / IMP11

UMN1N / UMP1N / UMN11N / UMP11N

●Applications

Ultra high speed switching

●Features

- 1) A wide variety of configurations are available.
(UMD5, UMD6, SMD5, SMD6)
- 2) Multiple diodes in one small surface mount package.
- 3) Diode characteristics are matched in the package.

●Construction

Silicon epitaxial planar

●External dimensions (Units : mm)

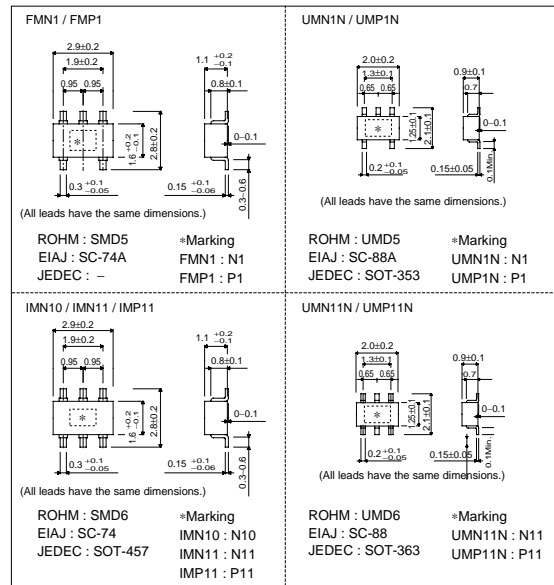

●Circuit

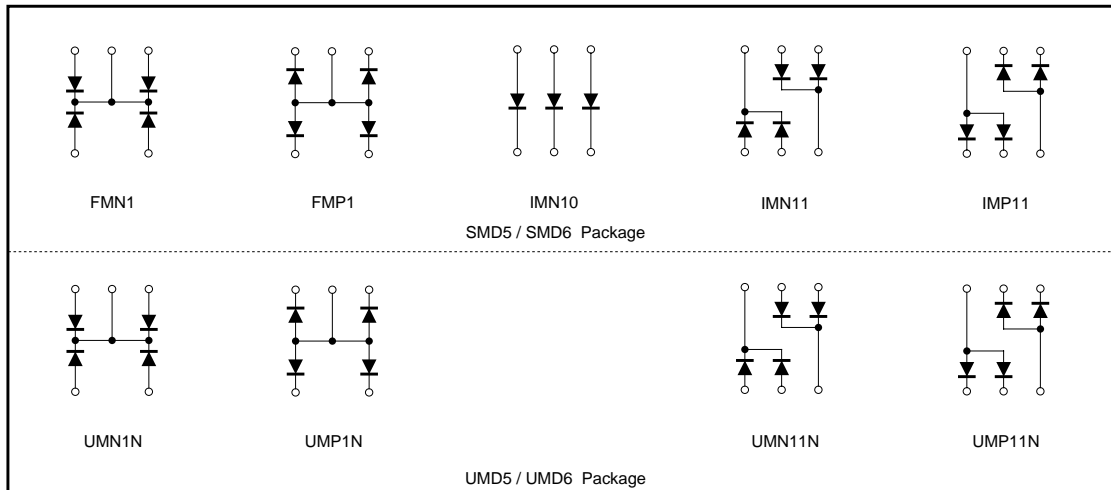

Diodes

FMN1 / FMP1 / IMN10 / IMN11 / IMP11 / UMN1N / UMP1N / UMN11N / UMP11N

●Absolute maximum ratings (Ta=25°C)

Type	Peak reverse voltage V _{RM} (V)	DC reverse voltage V _R (V)	Peak forward current I _{FM} (mA)	Mean rectifying current I _o (mA)	Surge current (1μs) I _{surge} (A)	Power dissipation (TOTAL) Pd (mW)	Junction temperature T _j (°C)	Storage temperature T _{stg} (°C)
FMN1 UMN1N	80	80	80	25	0.25	150/80	150	-55~+150
FMP1 UMP1N	80	80	80	25	0.25	150/80	150	-55~+150
IMN10	80	80	300	100	4	300 *1	150	-55~+150
IMN11 UMN11N	80	80	300	100	4	150 *2	150	-55~+150
IMP11 UMP11N	80	80	300	100	4	150 *2	150	-55~+150

*1 Not to exceed 200mW per element.

*2 Not to exceed 120mW per element.

●Electrical characteristics (Ta=25°C)

Type	Forward voltage		Reverse current		Capacitance between terminals			Reverse recovery time		
	V _F (V) Max.	Cond.	I _R (μA) Max.	Cond.	C _T (pF) Max.	Cond.		t _{rr} (ns) Max.	Cond.	
		I _F (mA)		V _R (V)		V _R (V)	f (MHz)		V _R (V)	I _F (mA)
FMN1 UMN1N	0.9	5	0.1	70	3.5	6	1	4	6	5
FMP1 UMP1N	0.9	5	0.1	70	3.5	6	1	4	6	5
IMN10	1.2	100	0.1	70	3.5	6	1	4	6	5
IMN11 UMN11N	1.2	100	0.1	70	3.5	6	1	4	6	5
IMP11 UMP11N	1.2	100	0.1	70	3.5	6	1	4	6	5

●Electrical characteristic curves (Ta=25°C)

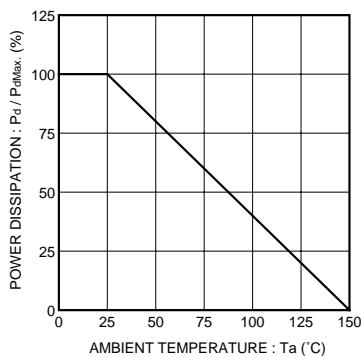

Fig.1 Power reduction curve

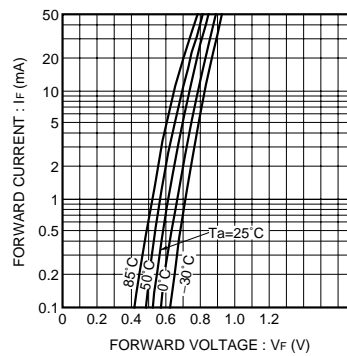

Fig.2 Forward current vs. forward voltage (P Type)

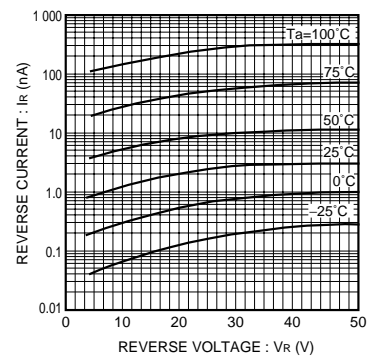

Fig.3 Reverse current vs. reverse voltage (P Type)

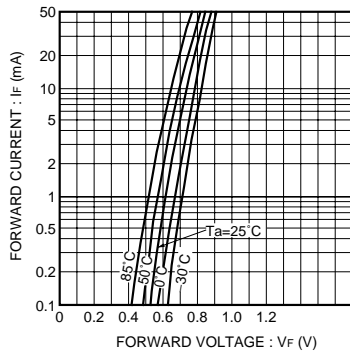

Fig.4 Forward current vs. forward voltage (N Type)

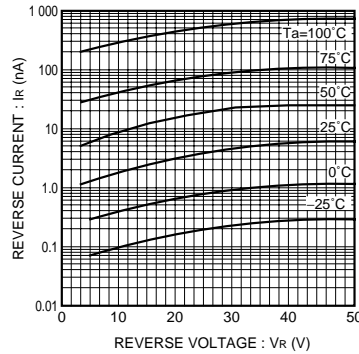

Fig.5 Reverse current vs. reverse voltage (N Type)

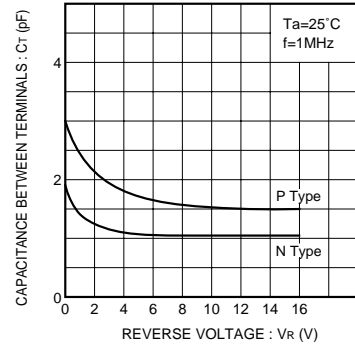

Fig.6 Capacitance between terminals vs. reverse voltage

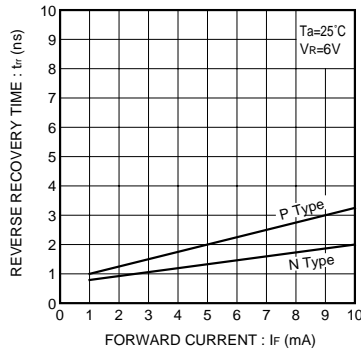

Fig.7 Reverse recovery time vs. forward current

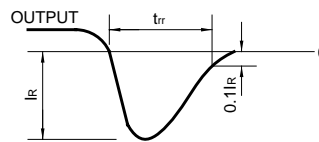
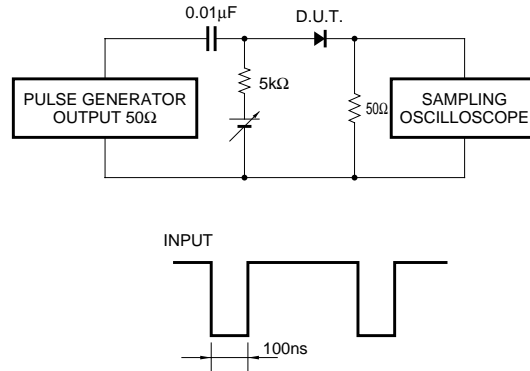

Fig.8 Reverse recovery time (t_{rr}) measurement circuit