

Features

- High Voltage Type (20V Rating)
- Encodes 10 Line to 4 Line BCD
- Active Low Inputs and Outputs
- 100% Tested for Quiescent Current at 20V
- 5V, 10V and 15V Parametric Ratings
- Maximum Input Current of 1 μ A at 18V Over Full Package Temperature Range; 100nA at 18V and +25 $^{\circ}$ C
- Noise Margin (Over Full Package/Temperature Range)
 - 1V at VDD = 5V
 - 2V at VDD = 10V
 - 2.5V at VDD = 15V
- Standardized Symmetrical Output Characteristics
- Meets All Requirements of JEDEC Tentative Standard No. 13B, "Standard Specifications for Description of 'B' Series CMOS Devices"

Applications

- Keyboard Encoding
- 10 Line to BCD Encoding
- Range Selection

Description

CD40147BMS CMOS encoder features priority encoding of the inputs to ensure that only the highest order data line is encoded. Ten data input lines (0-9) are encoded to four line (8, 4, 2, 1) BCD. The highest priority line is line 9. All four output lines are logic 1 (VSS) when all input lines are logic 0. All inputs and outputs are buffered, and each output can drive one TTL low power Schottky load. The CD40147BMS is functionally similar to the TTL 54/74147 if pin 15 is tied low.

The CD40147BMS is supplied in these 16-lead outline packages:

Braze Seal DIP	H4T
Frit Seal DIP	H1E
Ceramic Flatpack	H6W

Pinout

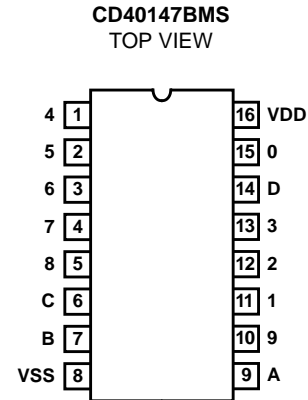

Functional Diagram

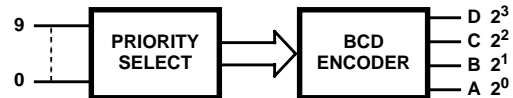

Specifications CD40147BMS

Absolute Maximum Ratings

DC Supply Voltage Range, (VDD)	-0.5V to +20V (Voltage Referenced to VSS Terminals)
Input Voltage Range, All Inputs	-0.5V to VDD +0.5V
DC Input Current, Any One Input	±10mA
Operating Temperature Range	-55°C to +125°C Package Types D, F, K, H
Storage Temperature Range (TSTG)	-65°C to +150°C
Lead Temperature (During Soldering)	+265°C At Distance 1/16 ± 1/32 Inch (1.59mm ± 0.79mm) from case for 10s Maximum

Reliability Information

Thermal Resistance	θ_{ja}	θ_{jc}
Ceramic DIP and FRIT Package	80°C/W	20°C/W
Flatpack Package	70°C/W	20°C/W
Maximum Package Power Dissipation (PD) at +125°C		
For T _A = -55°C to +100°C (Package Type D, F, K)	500mW	
For T _A = +100°C to +125°C (Package Type D, F, K)	Derate Linearity at 12mW/°C to 200mW	
Device Dissipation per Output Transistor	100mW	
For T _A = Full Package Temperature Range (All Package Types)		
Junction Temperature	+175°C	

TABLE 1. DC ELECTRICAL PERFORMANCE CHARACTERISTICS

PARAMETER	SYMBOL	CONDITIONS (NOTE 1)		GROUP A SUBGROUPS	TEMPERATURE	LIMITS		UNITS
						MIN	MAX	
Supply Current	IDD	VDD = 20V, VIN = VDD or GND		1	+25°C	-	2	µA
				2	+125°C	-	200	µA
		VDD = 18V, VIN = VDD or GND		3	-55°C	-	2	µA
Input Leakage Current	IIL	VIN = VDD or GND	VDD = 20	1	+25°C	-100	-	nA
				2	+125°C	-1000	-	nA
			VDD = 18V	3	-55°C	-100	-	nA
Input Leakage Current	IIH	VIN = VDD or GND	VDD = 20	1	+25°C	-	100	nA
				2	+125°C	-	1000	nA
			VDD = 18V	3	-55°C	-	100	nA
Output Voltage	VOL15	VDD = 15V, No Load		1, 2, 3	+25°C, +125°C, -55°C	-	50	mV
Output Voltage	VOH15	VDD = 15V, No Load (Note 3)		1, 2, 3	+25°C, +125°C, -55°C	14.95	-	V
Output Current (Sink)	IOL5	VDD = 5V, VOUT = 0.4V		1	+25°C	0.53	-	mA
Output Current (Sink)	IOL10	VDD = 10V, VOUT = 0.5V		1	+25°C	1.4	-	mA
Output Current (Sink)	IOL15	VDD = 15V, VOUT = 1.5V		1	+25°C	3.5	-	mA
Output Current (Source)	IOH5A	VDD = 5V, VOUT = 4.6V		1	+25°C	-	-0.53	mA
Output Current (Source)	IOH5B	VDD = 5V, VOUT = 2.5V		1	+25°C	-	-1.8	mA
Output Current (Source)	IOH10	VDD = 10V, VOUT = 9.5V		1	+25°C	-	-1.4	mA
Output Current (Source)	IOH15	VDD = 15V, VOUT = 13.5V		1	+25°C	-	-3.5	mA
N Threshold Voltage	VNTH	VDD = 10V, ISS = -10µA		1	+25°C	-2.8	-0.7	V
P Threshold Voltage	VPTH	VSS = 0V, IDD = 10µA		1	+25°C	0.7	2.8	V
Functional	F	VDD = 2.8V, VIN = VDD or GND		7	+25°C	VOH > VDD/2	VOL < VDD/2	V
		VDD = 20V, VIN = VDD or GND		7	+25°C			
		VDD = 18V, VIN = VDD or GND		8A	+125°C			
		VDD = 3V, VIN = VDD or GND		8B	-55°C			
Input Voltage Low (Note 2)	VIL	VDD = 5V, VOH > 4.5V, VOL < 0.5V		1, 2, 3	+25°C, +125°C, -55°C	-	1.5	V
Input Voltage High (Note 2)	VIH	VDD = 5V, VOH > 4.5V, VOL < 0.5V		1, 2, 3	+25°C, +125°C, -55°C	3.5	-	V
Input Voltage Low (Note 2)	VIL	VDD = 15V, VOH > 13.5V, VOL < 1.5V		1, 2, 3	+25°C, +125°C, -55°C	-	4	V
Input Voltage High (Note 2)	VIH	VDD = 15V, VOH > 13.5V, VOL < 1.5V		1, 2, 3	+25°C, +125°C, -55°C	11	-	V

NOTES: 1. All voltages referenced to device GND, 100% testing being implemented. 3. For accuracy, voltage is measured differentially to VDD. Limit is 0.050V max.
2. Go/No Go test with limits applied to inputs.

Specifications CD40147BMS

TABLE 2. AC ELECTRICAL PERFORMANCE CHARACTERISTICS

PARAMETER	SYMBOL	CONDITIONS (NOTE 1, 2)	GROUP A SUBGROUPS	TEMPERATURE	LIMITS		UNITS
					MIN	MAX	
Propagation Delay In Phase Output	TPHL1 TPLH1	VDD = 5V, VIN = VDD or GND	9	+25°C	-	900	ns
			10, 11	+125°C, -55°C	-	1215	ns
Transition Time	TTHL TTLH	VDD = 5V, VIN = VDD or GND	9	+25°C	-	200	ns
			10, 11	+125°C, -55°C	-	270	ns

NOTES:

1. CL = 50pF, RL = 200K, Input TR, TF < 20ns.
2. -55°C and +125°C limits guaranteed, 100% testing being implemented.

TABLE 3. ELECTRICAL PERFORMANCE CHARACTERISTICS

PARAMETER	SYMBOL	CONDITIONS	NOTES	TEMPERATURE	LIMITS		UNITS
					MIN	MAX	
Supply Current	IDD	VDD = 5V, VIN = VDD or GND	1, 2	-55°C, +25°C	-	1	μA
				+125°C	-	30	μA
		VDD = 10V, VIN = VDD or GND	1, 2	-55°C, +25°C	-	2	μA
				+125°C	-	60	μA
		VDD = 15V, VIN = VDD or GND	1, 2	-55°C, +25°C	-	2	μA
				+125°C	-	120	μA
Output Voltage	VOL	VDD = 5V, No Load	1, 2	+25°C, +125°C, -55°C	-	50	mV
Output Voltage	VOL	VDD = 10V, No Load	1, 2	+25°C, +125°C, -55°C	-	50	mV
Output Voltage	VOH	VDD = 5V, No Load	1, 2	+25°C, +125°C, -55°C	4.95	-	V
Output Voltage	VOH	VDD = 10V, No Load	1, 2	+25°C, +125°C, -55°C	9.95	-	V
Output Current (Sink)	IOL5	VDD = 5V, VOUT = 0.4V	1, 2	+125°C	0.36	-	mA
				-55°C	0.64	-	mA
Output Current (Sink)	IOL10	VDD = 10V, VOUT = 0.5V	1, 2	+125°C	0.9	-	mA
				-55°C	1.6	-	mA
Output Current (Sink)	IOL15	VDD = 15V, VOUT = 1.5V	1, 2	+125°C	2.4	-	mA
				-55°C	4.2	-	mA
Output Current (Source)	IOH5A	VDD = 5V, VOUT = 4.6V	1, 2	+125°C	-	-0.36	mA
				-55°C	-	-0.64	mA
Output Current (Source)	IOH5B	VDD = 5V, VOUT = 2.5V	1, 2	+125°C	-	-1.15	mA
				-55°C	-	-2.0	mA
Output Current (Source)	IOH10	VDD = 10V, VOUT = 9.5V	1, 2	+125°C	-	-0.9	mA
				-55°C	-	-1.6	mA
Output Current (Source)	IOH15	VDD = 15V, VOUT = 13.5V	1, 2	+125°C	-	-2.4	mA
				-55°C	-	-4.2	mA
Input Voltage Low	VIL	VDD = 10V, VOH > 9V, VOL < 1V	1, 2	+25°C, +125°C, -55°C	-	3	V
Input Voltage High	VIH	VDD = 10V, VOH > 9V, VOL < 1V	1, 2	+25°C, +125°C, -55°C	+7	-	V

Specifications CD40147BMS

TABLE 3. ELECTRICAL PERFORMANCE CHARACTERISTICS (Continued)

PARAMETER	SYMBOL	CONDITIONS	NOTES	TEMPERATURE	LIMITS		UNITS
					MIN	MAX	
Propagation Delay In Phase Output	TPHL TPLH	VDD = 10V	1, 2, 3	+25°C	-	400	ns
		VDD = 15V	1, 2, 3	+25°C	-	300	ns
Propagation Delay Out of Phase Output	TPHL TPLH	VDD = 5V	1, 2, 3	+25°C	-	850	ns
		VDD = 10V	1, 2, 3	+25°C	-	350	ns
		VDD = 15V	1, 2, 3	+25°C	-	250	ns
Transition Time	TTLH	VDD = 10V	1, 2, 3	+25°C	-	100	ns
		VDD = 15V	1, 2, 3	+25°C	-	80	ns
Input Capacitance	CIN	Any Input	1, 2	+25°C	-	7.5	pF

NOTES:

1. All voltages referenced to device GND.
2. The parameters listed on Table 3 are controlled via design or process and are not directly tested. These parameters are characterized on initial design release and upon design changes which would affect these characteristics.
3. CL = 50pF, RL = 200K, Input TR, TF < 20ns.

TABLE 4. POST IRRADIATION ELECTRICAL PERFORMANCE CHARACTERISTICS

PARAMETER	SYMBOL	CONDITIONS	NOTES	TEMPERATURE	LIMITS		UNITS
					MIN	MAX	
Supply Current	IDD	VDD = 20V, VIN = VDD or GND	1, 4	+25°C	-	7.5	μA
N Threshold Voltage	VNTH	VDD = 10V, ISS = -10μA	1, 4	+25°C	-2.8	-0.2	V
N Threshold Voltage Delta	ΔVTN	VDD = 10V, ISS = -10μA	1, 4	+25°C	-	±1	V
P Threshold Voltage	VTP	VSS = 0V, IDD = 10μA	1, 4	+25°C	0.2	2.8	V
P Threshold Voltage Delta	ΔVTP	VSS = 0V, IDD = 10μA	1, 4	+25°C	-	±1	V
Functional	F	VDD = 18V, VIN = VDD or GND	1	+25°C	VOH > VDD/2	VOL < VDD/2	V
		VDD = 3V, VIN = VDD or GND					
Propagation Delay Time	TPHL TPLH	VDD = 5V	1, 2, 3, 4	+25°C	-	1.35 x +25°C Limit	ns

- NOTES: 1. All voltages referenced to device GND. 2. CL = 50pF, RL = 200K, Input TR, TF < 20ns. 3. See Table 2 for +25°C limit. 4. Read and Record

TABLE 5. BURN-IN AND LIFE TEST DELTA PARAMETERS +25°C

PARAMETER	SYMBOL	DELTA LIMIT
Supply Current - MSI-1	IDD	± 0.2μA
Output Current (Sink)	IOL5	± 20% x Pre-Test Reading
Output Current (Source)	IOH5A	± 20% x Pre-Test Reading

TABLE 6. APPLICABLE SUBGROUPS

CONFORMANCE GROUP	MIL-STD-883 METHOD	GROUP A SUBGROUPS	READ AND RECORD
Initial Test (Pre Burn-In)	100% 5004	1, 7, 9	IDD, IOL5, IOH5A
Interim Test 1 (Post Burn-In)	100% 5004	1, 7, 9	IDD, IOL5, IOH5A
Interim Test 2 (Post Burn-In)	100% 5004	1, 7, 9	IDD, IOL5, IOH5A

Specifications CD40147BMS

TABLE 6. APPLICABLE SUBGROUPS (Continued)

CONFORMANCE GROUP		MIL-STD-883 METHOD	GROUP A SUBGROUPS	READ AND RECORD
PDA (Note 1)		100% 5004	1, 7, 9, Deltas	
Interim Test 3 (Post Burn-In)		100% 5004	1, 7, 9	IDD, IOL5, IOH5A
PDA (Note 1)		100% 5004	1, 7, 9, Deltas	
Final Test		100% 5004	2, 3, 8A, 8B, 10, 11	
Group A		Sample 5005	1, 2, 3, 7, 8A, 8B, 9, 10, 11	
Group B	Subgroup B-5	Sample 5005	1, 2, 3, 7, 8A, 8B, 9, 10, 11, Deltas	Subgroups 1, 2, 3, 9, 10, 11
	Subgroup B-6	Sample 5005	1, 7, 9	
Group D		Sample 5005	1, 2, 3, 8A, 8B, 9	Subgroups 1, 2 3

NOTE: 1. 5% Parametric, 3% Functional; Cumulative for Static 1 and 2.

TABLE 7. TOTAL DOSE IRRADIATION

CONFORMANCE GROUPS	MIL-STD-883 METHOD	TEST		READ AND RECORD	
		PRE-IRRAD	POST-IRRAD	PRE-IRRAD	POST-IRRAD
Group E Subgroup 2	5005	1, 7, 9	Table 4	1, 9	Table 4

TABLE 8. BURN-IN AND IRRADIATION TEST CONNECTIONS

FUNCTION	OPEN	GROUND	VDD	9V ± -0.5V	OSCILLATOR	
					50kHz	25kHz
Static Burn-In 1 Note 1	6, 7, 9, 14	1-5, 8, 10-13, 15	16			
Static Burn-In 2 Note 1	6, 7, 9, 14	8	1-5, 10-13, 15, 16			
Dynamic Burn-In Note 1	-	8	16	6, 7, 9, 14	1, 3, 11, 13	2, 4, 5, 10, 12, 15
Irradiation Note 2	6, 7, 9, 14	8	1-5, 10-13, 15, 16			

NOTE:

- Each pin except VDD and GND will have a series resistor of $10K \pm 5\%$, $VDD = 18V \pm 0.5V$
- Each pin except VDD and GND will have a series resistor of $47K \pm 5\%$; Group E, Subgroup 2, sample size is 4 dice/wafer, 0 failures, $VDD = 10V \pm 0.5V$

All Intersil semiconductor products are manufactured, assembled and tested under **ISO9000** quality systems certification.

Intersil products are sold by description only. Intersil Corporation reserves the right to make changes in circuit design and/or specifications at any time without notice. Accordingly, the reader is cautioned to verify that data sheets are current before placing orders. Information furnished by Intersil is believed to be accurate and reliable. However, no responsibility is assumed by Intersil or its subsidiaries for its use; nor for any infringements of patents or other rights of third parties which may result from its use. No license is granted by implication or otherwise under any patent or patent rights of Intersil or its subsidiaries.

For information regarding Intersil Corporation and its products, see web site <http://www.intersil.com>

Sales Office Headquarters

NORTH AMERICA

Intersil Corporation
P. O. Box 883, Mail Stop 53-204
Melbourne, FL 32902
TEL: (321) 724-7000
FAX: (321) 724-7240

EUROPE

Intersil SA
Mercure Center
100, Rue de la Fusee
1130 Brussels, Belgium
TEL: (32) 2.724.2111
FAX: (32) 2.724.22.05

ASIA

Intersil (Taiwan) Ltd.
Taiwan Limited
7F-6, No. 101 Fu Hsing North Road
Taipei, Taiwan
Republic of China
TEL: (886) 2 2716 9310
FAX: (886) 2 2715 3029

CD40147BMS

Logic Diagram

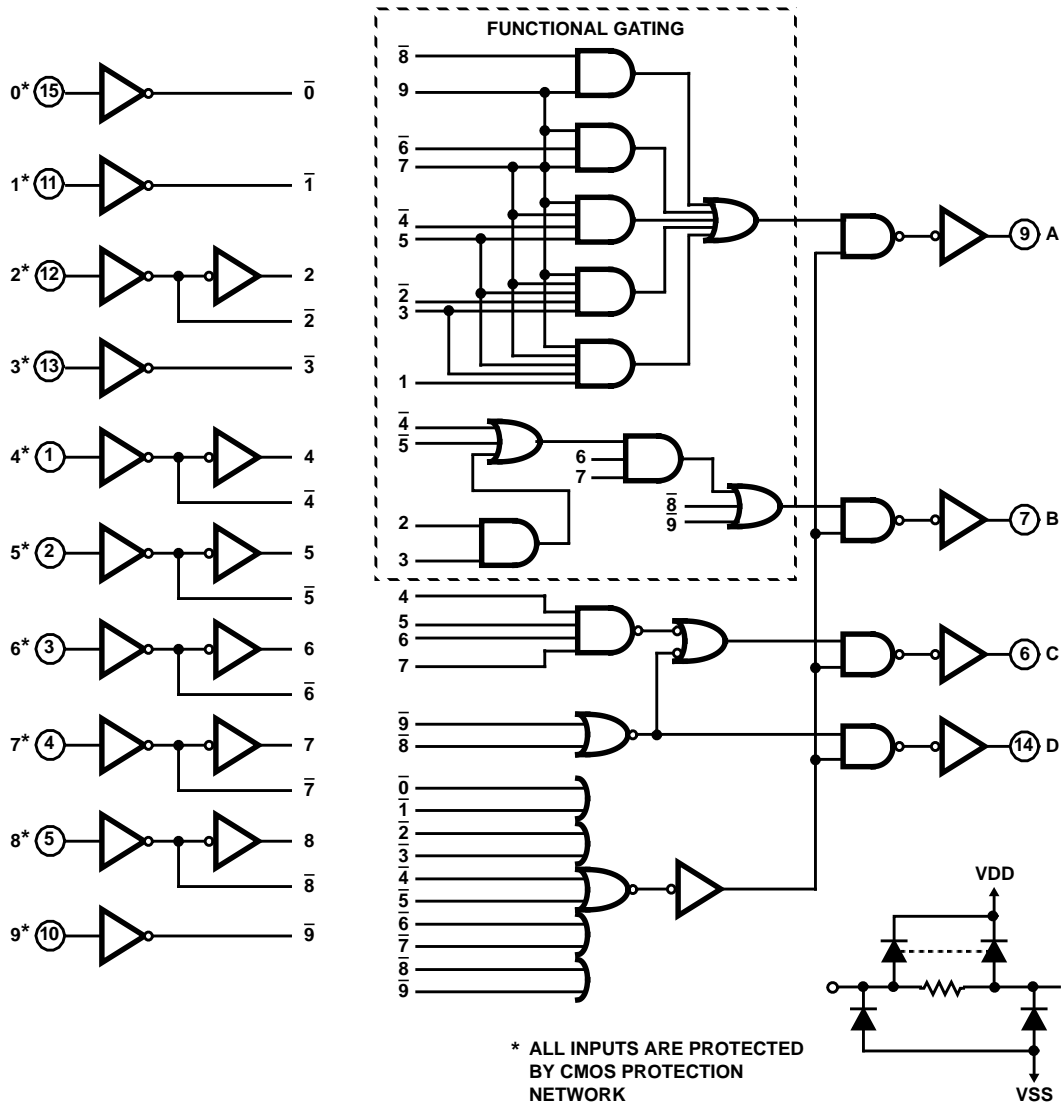

FIGURE 1.

TRUTH TABLE (Negative Logic)

INPUTS										OUTPUTS			
0	1	2	3	4	5	6	7	8	9	D	C	B	A
0	0	0	0	0	0	0	0	0	0	1	1	1	1
1	0	0	0	0	0	0	0	0	0	0	0	0	0
X	1	0	0	0	0	0	0	0	0	0	0	1	0
X	X	1	0	0	0	0	0	0	0	0	0	1	1
X	X	X	1	0	0	0	0	0	0	0	1	0	0
X	X	X	X	1	0	0	0	0	0	0	1	0	1
X	X	X	X	X	1	0	0	0	0	0	1	1	0
X	X	X	X	X	X	1	0	0	0	0	1	1	1
X	X	X	X	X	X	X	1	0	0	1	0	0	0
X	X	X	X	X	X	X	X	1	0	1	0	0	0
X	X	X	X	X	X	X	X	X	1	1	0	0	1

0 = High level 1 = Low level X = Don't care

Typical Performance Characteristics

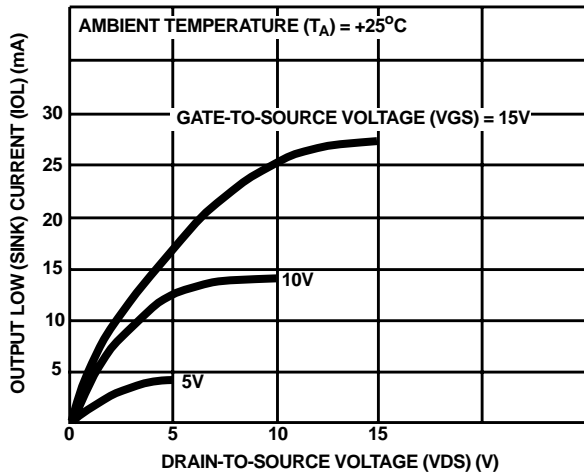

FIGURE 2. TYPICAL OUTPUT LOW (SINK) CURRENT CHARACTERISTICS

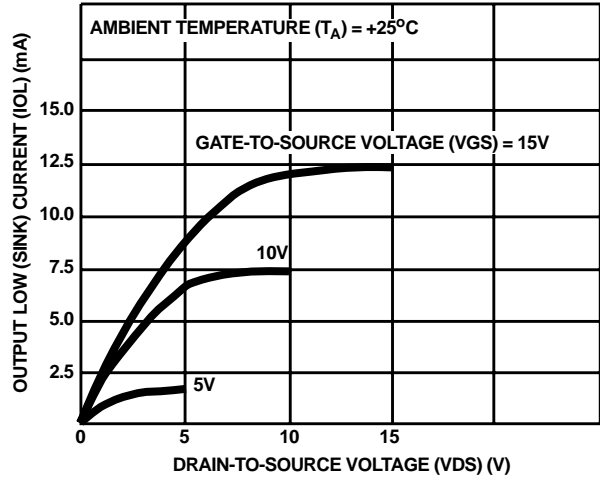

FIGURE 3. MINIMUM OUTPUT LOW (SINK) CURRENT CHARACTERISTICS

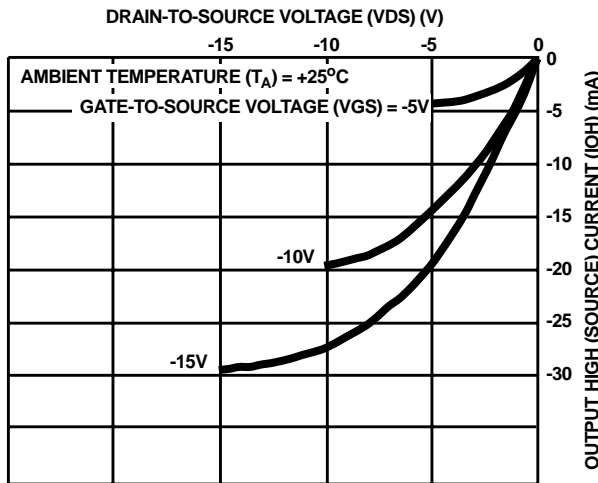

FIGURE 4. TYPICAL OUTPUT HIGH (SOURCE) CURRENT CHARACTERISTICS

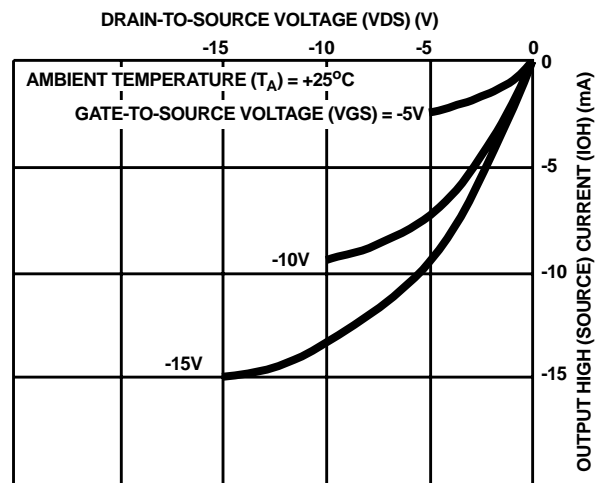

FIGURE 5. MINIMUM OUTPUT HIGH (SOURCE) CURRENT CHARACTERISTICS

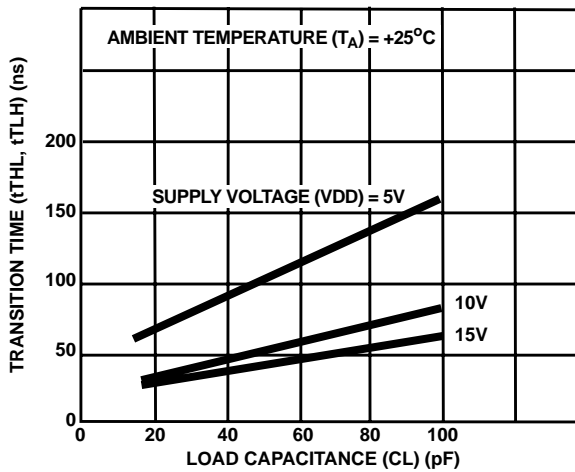

FIGURE 6. TYPICAL TRANSITION TIME AS A FUNCTION OF LOAD CAPACITANCE

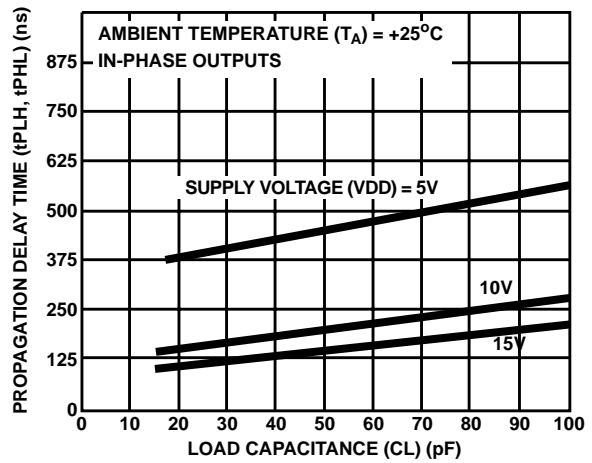

FIGURE 7. PROPAGATION DELAY TIME AS A FUNCTION OF LOAD CAPACITANCE

CD40147BMS

Typical Performance Characteristics (Continued)

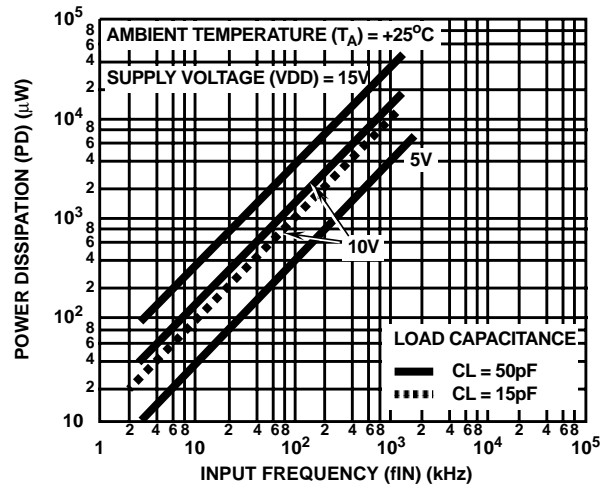
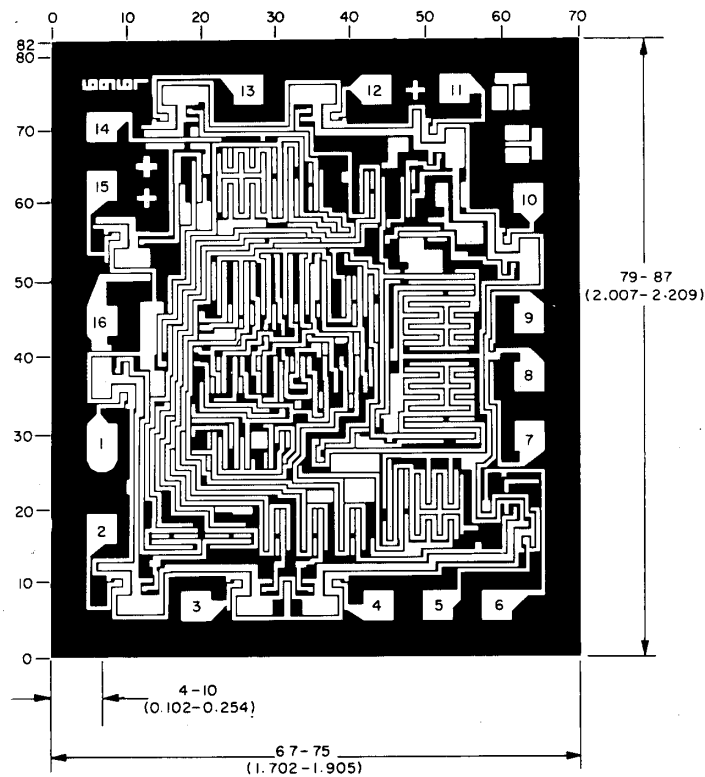

FIGURE 8. TYPICAL DYNAMIC POWER DISSIPATION AS A FUNCTION OF INPUT FREQUENCY

Chip Dimensions and Pad Layout



Dimensions in parenthesis are in millimeters and are derived from the basic inch dimensions as indicated. Grid graduations are in mils (10^{-3} inch).

METALLIZATION: Thickness: $11\text{k}\text{\AA} - 14\text{k}\text{\AA}$, AL.

PASSIVATION: $10.4\text{k}\text{\AA} - 15.6\text{k}\text{\AA}$, Silane

BOND PADS: 0.004 inches X 0.004 inches MIN

DIE THICKNESS: 0.0198 inches - 0.0218 inches