

# MOS FIELD EFFECT TRANSISTOR

## 2SK1272

### N-CHANNEL MOS FET FOR HIGH SPEED SWITCHING

#### PACKAGE DIMENSIONS (Unit : mm)

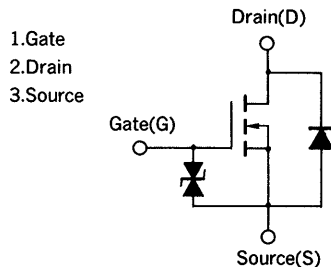
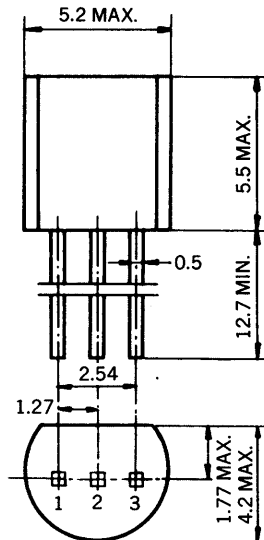

(Diode in the figure is the parasitic diode.)

The 2SK1272, N-channel vertical type MOS FET, is a switching device which can be driven directly by the output of ICs having a 5 V power source.

The MOS FET has excellent switching characteristics and is suitable for use as a high-speed switching device in digital circuits.

#### FEATURES

- Directly driven by ICs having a 5 V power source.
- Not necessary to consider driving current because of its high input impedance.
- Possible to reduce the number of parts by omitting the bias resistor.
- Low ON-state resistance

$$R_{DS(on)} = 1.00 \Omega \text{ TYP. at } V_{GS} = 4 \text{ V, } I_D = 0.5 \text{ A}$$

$$R_{DS(on)} = 0.65 \Omega \text{ TYP. at } V_{GS} = 10 \text{ V, } I_D = 0.5 \text{ A}$$

#### QUALITY GRADE

Standard

Please refer to "Quality grade on NEC Semiconductor Devices" (Document number IEI-1209) published by NEC Corporation to know the specification of quality grade on the devices and its recommended applications.

#### ABSOLUTE MAXIMUM RATINGS ( $T_a = 25^\circ\text{C}$ )

| PARAMETER               | SYMBOL              | RATINGS     | UNIT             | TEST CONDITIONS                                |
|-------------------------|---------------------|-------------|------------------|--|
| Drain to Source Voltage | $V_{DSS}$           | 60          | V                | $V_{GS} = 0$                                   |
| Gate to Source Voltage  | $V_{GSS}$           | $\pm 20$    | V                | $V_{DS} = 0$                                   |
| Drain Current           | $I_D(\text{DC})$    | $\pm 1.0$   | A                |  |
| Drain Current           | $I_D(\text{pulse})$ | $\pm 2.0$   | A                | $PW \leq 10 \text{ ms, Duty Cycle} \leq 50 \%$ |
| Total Power Dissipation | $P_T$               | 750         | mW               |  |
| Channel Temperature     | $T_{ch}$            | 150         | $^\circ\text{C}$ |  |
| Storage Temperature     | $T_{stg}$           | -55 to +150 | $^\circ\text{C}$ |  |

ELECTRICAL CHARACTERISTICS (T<sub>a</sub> = 25 °C)

| PARAMETER                           | SYMBOL               | MIN. | TYP. | MAX. | UNIT | TEST CONDITIONS  |
|-------------------------------------|----------------------|------|------|------|------|--|
| Drain Cut-off Current               | I <sub>DSS</sub>     |      |      | 10   | μA   | V <sub>DS</sub> = 60 V, V <sub>GS</sub> = 0  |
| Gate Leakage Current                | I <sub>GSS</sub>     |      |      | ±10  | μA   | V <sub>GS</sub> = ±20 V, V <sub>DS</sub> = 0   |
| Gate Cut-off Voltage                | V <sub>GS(off)</sub> | 1.0  | 1.7  | 2.5  | V    | V <sub>DS</sub> = 10 V, I <sub>D</sub> = 1 mA  |
| Forward Transfer Admittance         | y <sub>fs</sub>      | 0.4  |      |      | S    | V <sub>DS</sub> = 10 V, I <sub>D</sub> = 0.5 A   |
| Drain to Source On-State Resistance | R <sub>DS(on)1</sub> |      | 0.31 | 1.00 | Ω    | V <sub>GS</sub> = 4.0 V, I <sub>D</sub> = 0.5 A  |
| Drain to Source On-State Resistance | R <sub>DS(on)2</sub> |      | 0.24 | 0.65 | Ω    | V <sub>GS</sub> = 10 V, I <sub>D</sub> = 0.5 A   |
| Input Capacitance                   | C <sub>iss</sub>     |      | 220  |      | pF   | V <sub>DS</sub> = 10 V, V <sub>GS</sub> = 0, f = 1 MHz   |
| Output Capacitance                  | C <sub>oss</sub>     |      | 105  |      | pF   |  |
| Feedback Capacitance                | C <sub>rss</sub>     |      | 16   |      | pF   |  |
| Turn-On Delay Time                  | t <sub>d(on)</sub>   |      | 15   |      | ns   | V <sub>GS(on)</sub> = 10 V, R <sub>G</sub> = 10 Ω<br>V <sub>DD</sub> = 25 V, I <sub>D</sub> = 0.5 A<br>R <sub>L</sub> = 50 Ω |
| Rise Time                           | t <sub>r</sub>       |      | 35   |      | ns   |  |
| Turn-Off Delay Time                 | t <sub>d(off)</sub>  |      | 380  |      | ns   |  |
| Fall Time                           | t <sub>f</sub>       |      | 120  |      | ns   |  |

SWITCHING TIME MEASUREMENT CIRCUIT AND CONDITIONS

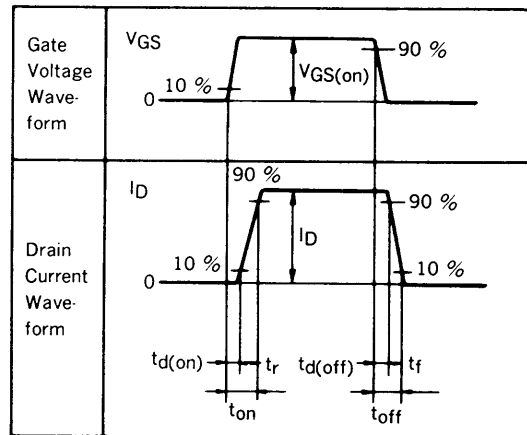
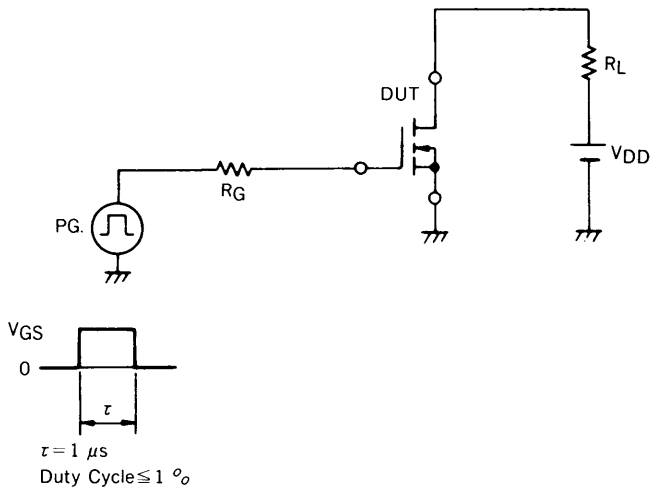

TYPICAL CHARACTERISTICS (T<sub>a</sub> = 25 °C)

DERATING FACTOR OF FORWARD BIAS SAFE OPERATING AREA

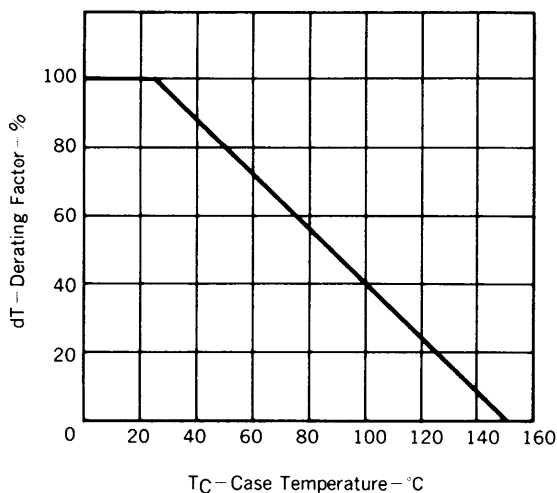

FORWARD BIAS SAFE OPERATING AREA

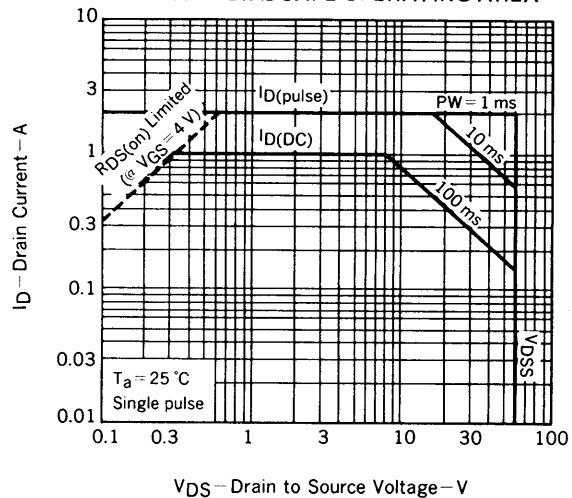

TOTAL POWER DISSIPATION vs. AMBIENT TEMPERATURE

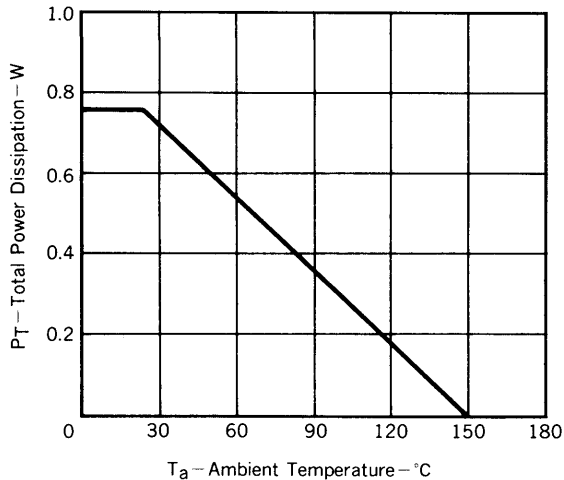

DRAIN CURRENT vs. DRAIN TO SOURCE VOLTAGE

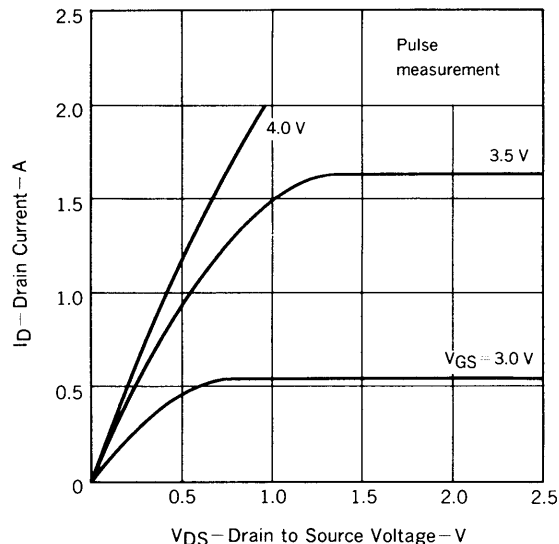

TRANSFER CHARACTERISTICS

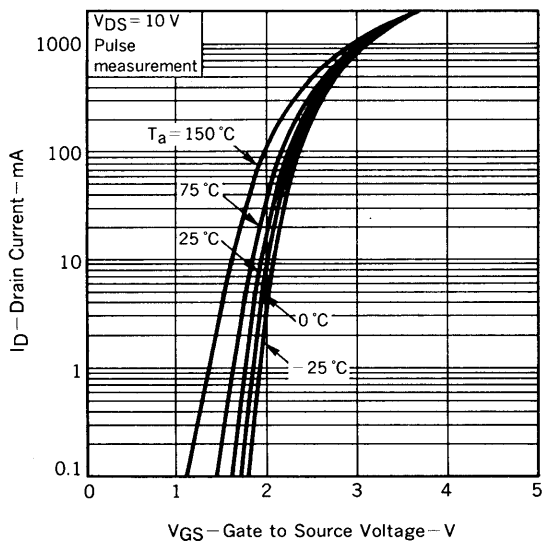

GATE TO SOURCE CUTOFF VOLTAGE vs. CHANNEL TEMPERATURE

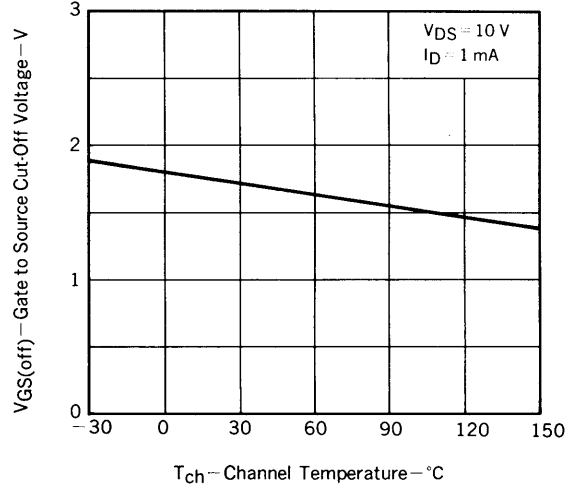

FORWARD TRANSFER ADMITTANCE vs. DRAIN CURRENT

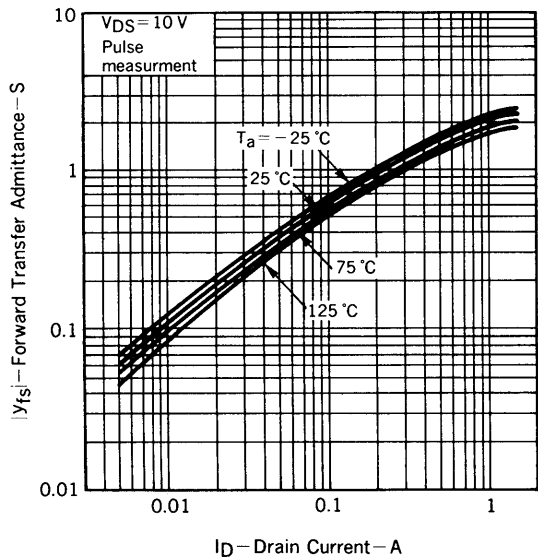

DRAIN TO SOURCE ON-STATE RESISTANCE vs. GATE TO SOURCE VOLTAGE

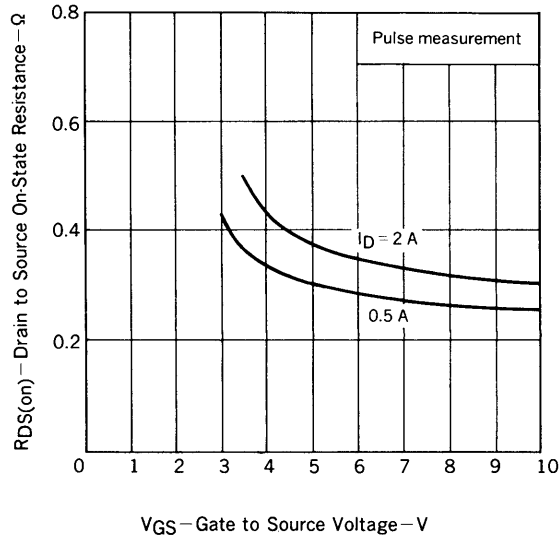

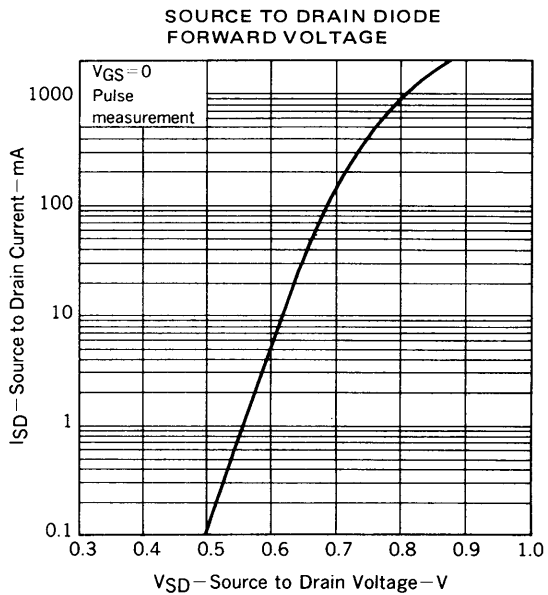
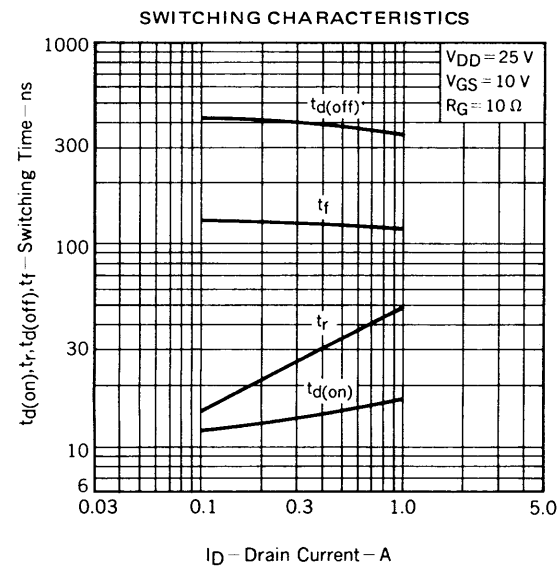
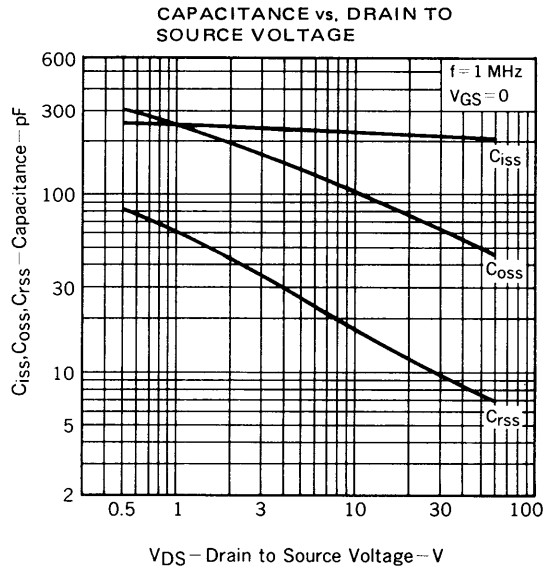
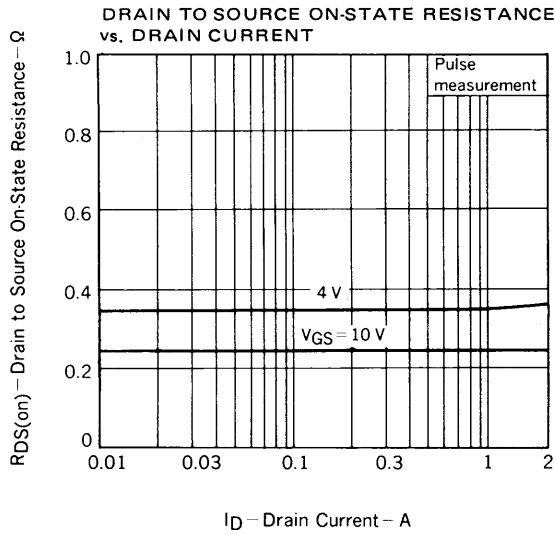
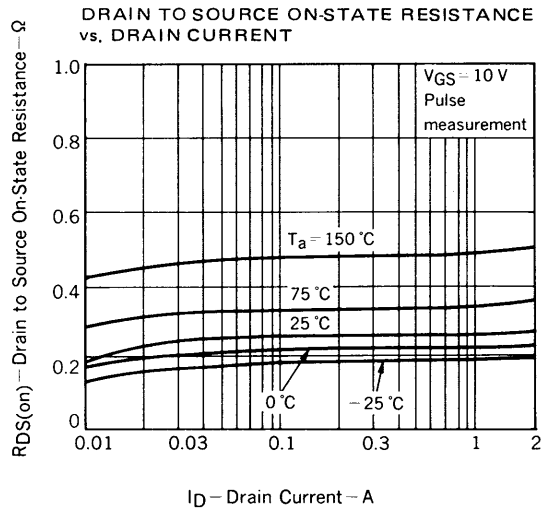
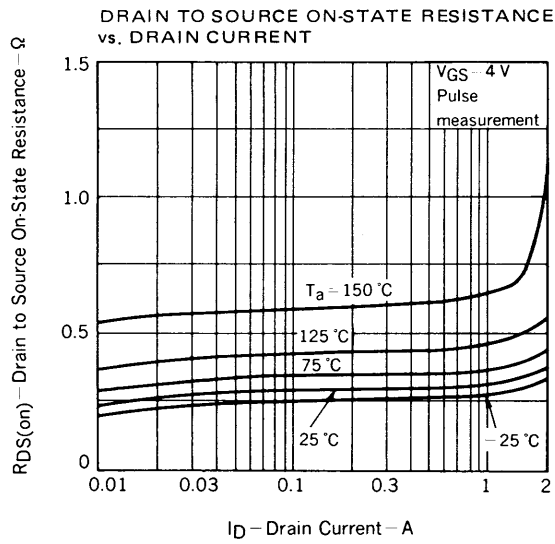

**RECOMMENDED SOLDERING CONDITIONS**

Solder this product under the following recommended conditions.

For soldering methods or soldering conditions other than those recommended in the table, please consult our NEC salespeople.

**Insert type**

| Soldering method | Soldering conditions  | Recommended condition code |
|------------------|---|----------------------------|
| Wave soldering   | Solder bath temperature: 260 °C max.<br>Soldering time: 10 sec max. |                            |

(MEMO)

No part of this document may be copied or reproduced in any form or by any means without the prior written consent of NEC Corporation. NEC Corporation assumes no responsibility for any errors which may appear in this document.

NEC corporation does not assume any liability for infringement of patents, copyrights or other intellectual property rights of third parties by or arising from use of a device described herein or any other liability arising from use of such device. No license, either express, implied or otherwise, is granted under any patents, copyrights or other intellectual property rights of NEC Corporation or others.

The devices listed in this document are not suitable for use in the field where very high reliability is required including, but not limited to, aerospace equipment, submarine cables, unclear reactor control systems and life support systems. If customers intend to use NEC devices for above applications or those inted to use "Standard", or "Special" quality grade NEC devices for the applications not intended by NEC, please contact our sales people in advance.

Application examples recomended by NEC Corporation

Standard: Data processing and office equipment, Communication equipment (terminal, mobile). Test and Measurement equipment, Audio and Video equipment, Other consumer products, etc.

Special: Automotive and Transportation equipment, Communication equipment (trunk line), Train and Traffic control devices, industrial robots, Burning control systems, antidisaster systems, anticrime systems etc.